



# High Performance BGA Cooling Solutions w/ Thermal Tape Attachment

**ATS PART # ATS-55330D-C2-R0**

## Features & Benefits

- » High efficiency cross-cut fin design provides low pressure drop characteristics
- » Large surface area increases heat sink performance
- » Designed for BGAs and surface mount packages
- » Comes preassembled with high performance thermal interface material

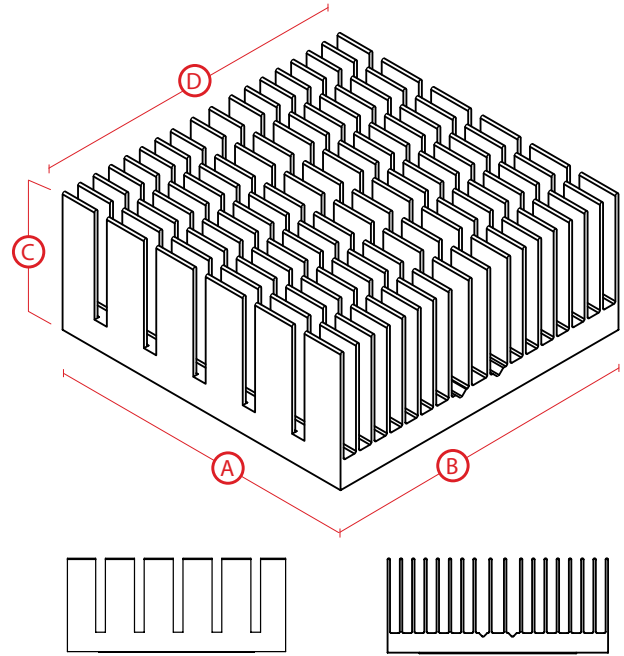

*\*Image above is for illustration purposes only.*

## Thermal Performance

AIR VELOCITY		THERMAL RESISTANCE	
FT/MIN	M/S	°C/W (UNDUCTED FLOW)	°C/W (DUCTED FLOW)
200	1.0	12.3	NA
300	1.5	NA	
400	2.0	NA	
500	2.5	NA	
600	3.0	NA	
700	3.5	NA	
800	4.0	NA	

## Product Details

DIMENSION A	DIMENSION B	DIMENSION C	DIMENSION D	INTERFACE MATERIAL	FINISH
33 mm	33 mm	9.5 mm	33 mm	SAINT-GOBAIN C675	BLACK-ANODIZED

### NOTES:

- 1) Dimension C = heat sink height from bottom of the base to the top of the fin field.
- 2) Thermal performance data are provided for reference only. Actual performance may vary by application.
- 3) ATS reserves the right to update or change its products without notice to improve the design or performance.
- 4) Contact ATS to learn about custom options available.



**ATS** ADVANCED THERMAL SOLUTIONS, INC.  
Innovations in Thermal Management®

**For more information, to find a distributor or to place an order, visit [www.qats.com](http://www.qats.com) or call: 781.769.2800 (North America); +31 (0) 3569 84715 (Europe).**