

PLEASE CHECK WWW.MOLEX.COM FOR LATEST PART INFORMATION

Part Number: [0767631001](#)
Status: **Active**
Overview: [vhdm_h](#)
Description: 2.00mm (.079") Pitch VHDM® H Board-to-Board Backplane Header, Vertical, 6-Row, Open End Module, 60 Circuits, Pin Length 4.75mm (.187"), Tin/Lead

Documents:

[Drawing \(PDF\)](#) [RoHS Certificate of Compliance \(PDF\)](#)
[Product Specification PS-74031-999 \(PDF\)](#)

General

Product Family	Backplane Connectors
Series	76763
Application	Backplane
Comments	No Keying Position
Component Type	PCB Header
Overview	vhdm_h
Product Name	VHDM® - H Series
Style	N/A

Physical

Circuits (Loaded)	60
Circuits (maximum)	60
Color - Resin	Black
Durability (mating cycles max)	200
First Mate / Last Break	No
Guide to Mating Part	No
Keying to Mating Part	None
Material - Metal	Copper Alloy
Material - Plating Mating	Gold
Material - Plating Termination	Tin-Lead
Material - Resin	High Temperature Thermoplastic
Number of Columns	10
Number of Pairs	Open Pin Field
Number of Rows	6
Orientation	Vertical
PC Tail Length (in)	0.072 In
PC Tail Length (mm)	1.83 mm
PCB Locator	No
PCB Retention	None
PCB Thickness Recommended (in)	0.072 In
PCB Thickness Recommended (mm)	1.83 mm
Packaging Type	Tube
Pitch - Mating Interface (in)	0.079 In
Pitch - Mating Interface (mm)	2.00 mm
Pitch - Term. Interface (in)	0.089 In
Pitch - Term. Interface (mm)	2.25 mm
Plating min: Mating (µin)	30
Plating min: Mating (µm)	0.75
Plating min: Termination (µin)	30
Plating min: Termination (µm)	0.75
Polarized to PCB	Yes
Stackable	No
Surface Mount Compatible (SMC)	Yes
Temperature Range - Operating	-55°C to +85°C
Termination Interface: Style	Through Hole - Compliant Pin

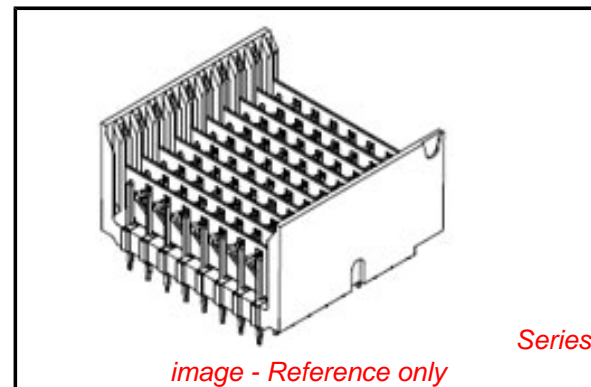

EU RoHS

RoHS Compliant by Exemption
REACH SVHC
 Not Reviewed
Halogen-Free
Status
Not Reviewed

China RoHS



Need more information on product environmental compliance?

Email productcompliance@molex.com
 For a multiple part number RoHS Certificate of Compliance, [click here](#)

Please visit the [Contact Us](#) section for any non-product compliance questions.

Search Parts in this Series

[76763Series](#)

Application Tooling | FAQ

Tooling specifications and manuals are found by selecting the products below. Crimp Height Specifications are then contained in the Application Tooling Specification document.

Global

Description	Product #
VHDM® Signal Pin	0622015700
Inserter Repair Tool	
VHDM® 6 Row Pin and Shield Repair Tool	0622015800
VHDM® 6 Row Shield Extraction Tool	0622016000
VHDM® Insertion Module for Advanced Mate Signal Header, 6 Row by 10 Wide, 20.00mm (.787")	0622020207

Electrical

Current - Maximum per Contact	1A
Data Rate	6.25 Gbps
Real Signals (per 25mm)	75
Shield Type	Ground Plane Shield
Shielded	Yes
Voltage - Maximum	120V AC (RMS)/DC

Material Info**Reference - Drawing Numbers**

Packaging Specification	PK-74057-003
Product Specification	PS-74031-999
Sales Drawing	SD-76763-001

VHDM and Very High Density Metric are trademarks of Amphenol Corporation

This document was generated on 05/20/2010

PLEASE CHECK WWW.MOLEX.COM FOR LATEST PART INFORMATION

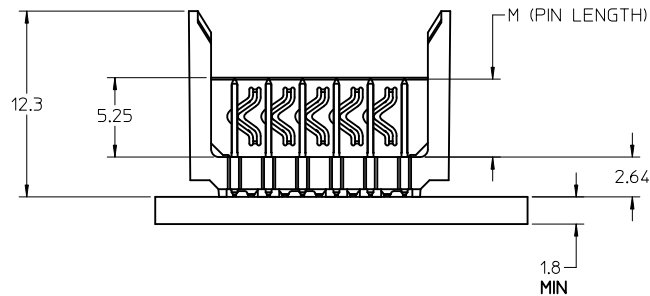
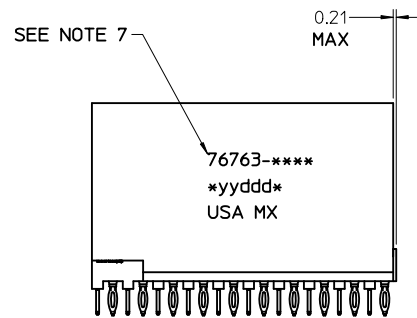
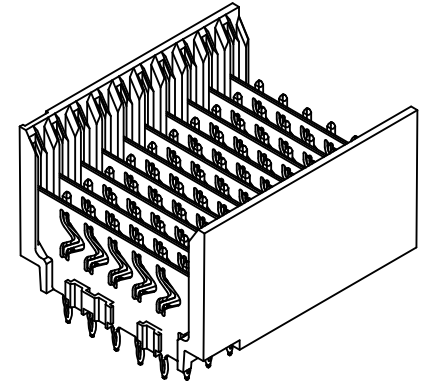
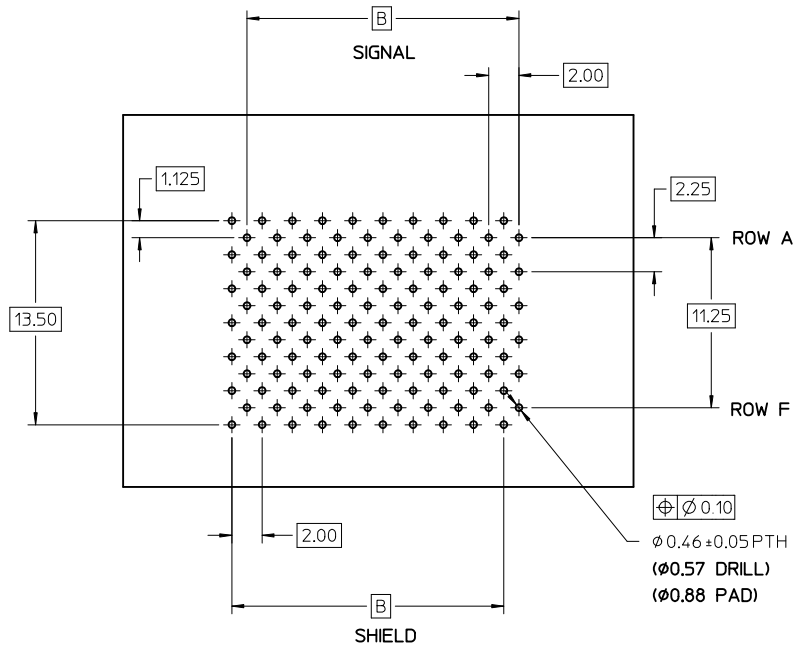
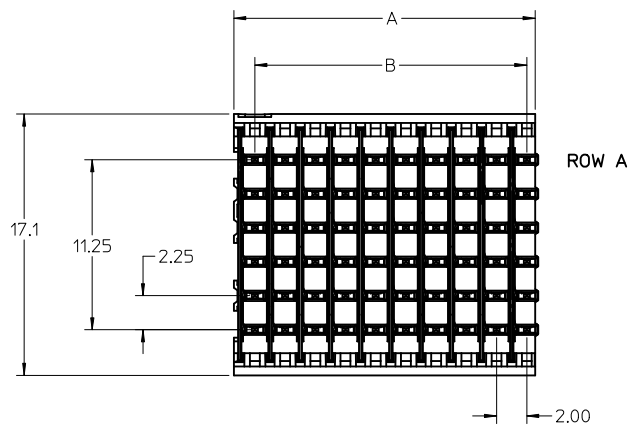

- NOTES:
- MATERIALS:
HOUSING - LIQUID CRYSTAL POLYMER (LCP)
GLASS FILLED, UL94V-0, BLACK
SIGNAL PIN AND SHIELD - COPPER ALLOY
 - FINISHES:
CONTACT AREA - SELECTIVE GOLD (Au)
PCB TAILS - SELECTIVE TIN/LEAD (SnPb) OR MATTE TIN (Sn)
3. THIS PART CONFORMS TO MOLEX PRODUCT SPECIFICATION PS-74031-999.
- FOR MIXED CONTACT LENGTH CONTACT MOLEX FOR AVAILABILITY.
 - FOR SPECIFIC MATERIAL NUMBERS AND MATING INFORMATION REFER TO SHEET 2.
 - PACKAGE PER PK-74057-003.
 - ASSEMBLY WILL BE MARKED WITH P/N AND DATE CODE WITH LASER MARK ON SIDE OF HOUSING OR BY LABEL ON THE TUBE.

SEE SHEET 2 EC NO: UCP2010-1510 DRWN: JONI AK 2010/03/05 CHKD: JELTON 2010/03/09 APPR: SMILLER 2010/03/09	QUALITY SYMBOLS ▽=0 ▽=0 ▽=0	GENERAL TOLERANCES (UNLESS SPECIFIED)		DIMENSION STYLE MM ONLY		SCALE 2:1	DESIGN UNITS METRIC	THIRD ANGLE PROJECTION		
		4 PLACES ± --- ± ---	3 PLACES ± --- ± ---	2 PLACES ± 0.15 ± ---	1 PLACE ± 0.25 ± ---	DRAWN BY JONI AK	DATE 2008/07/09	TITLE VHDM H-SERIES 6 ROW OPEN END BACKPLANE		
		ANGULAR ±1/2°		APPROVED BY SMILLER		DATE 2010/03/09	MATERIAL NO. DOCUMENT NO. SD-76763-001			
		DRAFT WHERE APPLICABLE MUST REMAIN WITHIN DIMENSIONS		SEE SHEET 2		SHEET NO. 1 OF 2				
THIS DRAWING CONTAINS INFORMATION THAT IS PROPRIETARY TO MOLEX INCORPORATED AND SHOULD NOT BE USED WITHOUT WRITTEN PERMISSION										

PART NUMBER	COLUMN	NUMBER OF SIGNAL PIN	NUMBER OF SHIELD	A	B	M	Au (um) THICKNESS
76763-1001	10	60	10	20.00	18.00	4.75	0.76
76763-1006							1.27
76763-1501	15	90	15	30.00	28.00		0.76
76763-1506							1.27
76763-2501	25	150	25	50.00	48.00	0.76	
76763-2506						1.27	
76763-1002	10	60	10	20.00	18.00	0.76	
76763-1007						1.27	
76763-1502	15	90	15	30.00	28.00	0.76	
76763-1507						1.27	
76763-2502	25	150	25	50.00	48.00	0.76	
76763-2507						1.27	
76763-1003	10	60	10	20.00	18.00	0.76	
76763-1008						1.27	
76763-1503	15	90	15	30.00	28.00	0.76	
76763-1508						1.27	
76763-2503	25	150	25	50.00	48.00	0.76	
76763-2508						1.27	
76763-1004	10	60	10	20.00	18.00	0.76	
76763-1009						1.27	
76763-1504	15	90	15	30.00	28.00	0.76	
76763-1509						1.27	
76763-2504	25	150	25	50.00	48.00	0.76	
76763-2509						1.27	

TIN/LEAD TABLE

PART NUMBER	COLUMN	NUMBER OF SIGNAL PIN	NUMBER OF SHIELD	A	B	M	Au (um) THICKNESS
76763-9001	10	60	10	20.00	18.00	4.75	0.76
76763-9006							1.27
76763-9501	15	90	15	30.00	28.00		0.76
76763-9506							1.27
76763-8501	25	150	25	50.00	48.00	0.76	
76763-8506						1.27	
76763-9002	10	60	10	20.00	18.00	0.76	
76763-9007						1.27	
76763-9502	15	90	15	30.00	28.00	0.76	
76763-9507						1.27	
76763-8502	25	150	25	50.00	48.00	0.76	
76763-8507						1.27	
76763-9003	10	60	10	20.00	18.00	0.76	
76763-9008						1.27	
76763-9503	15	90	15	30.00	28.00	0.76	
76763-9508						1.27	
76763-8503	25	150	25	50.00	48.00	0.76	
76763-8508						1.27	
76763-9004	10	60	10	20.00	18.00	0.76	
76763-9009						1.27	
76763-9504	15	90	15	30.00	28.00	0.76	
76763-9509						1.27	
76763-8504	25	150	25	50.00	48.00	0.76	
76763-8509						1.27	

LEAD FREE TABLE

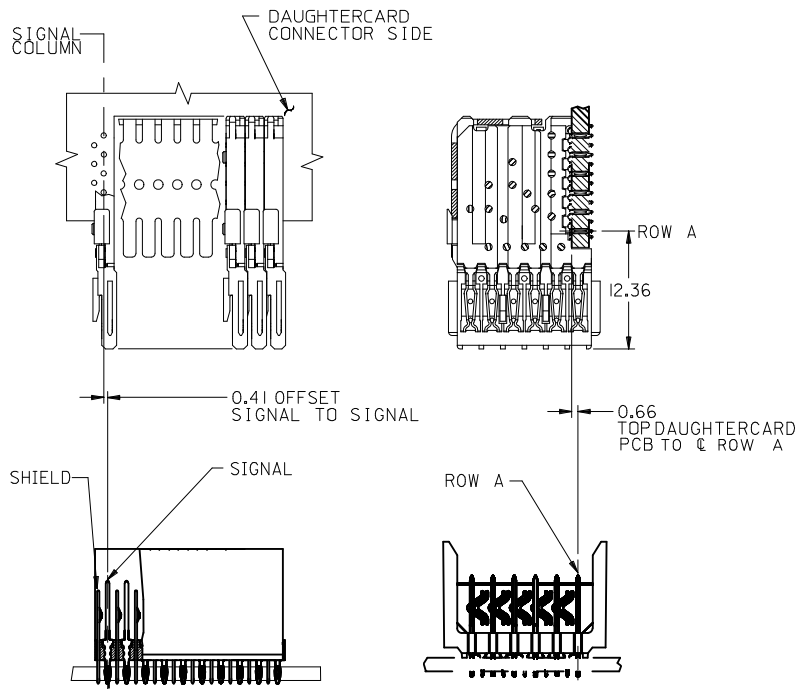

MATERIAL NUMBER ASSIGNMENT

76763-** ** SEE TABLES

- NUMBER OF COLUMNS/PLATING
- 10 = 10 COLUMN TIN/LEAD
- 15 = 15 COLUMN TIN/LEAD
- 25 = 25 COLUMN TIN/LEAD
- 90 = 10 COLUMN MATTE TIN
- 95 = 15 COLUMN MATTE TIN
- 85 = 25 COLUMN MATTE TIN

CORRECT P/Ns IN TABLES EC NO: UCP2010-1510 DRWN: JONIAK 2010/03/05 CHKD: JMLTON 2010/03/09 APPR: SMILLER 2010/03/09	QUALITY SYMBOLS ▽=0 ▽=0 ▽=0	GENERAL TOLERANCES (UNLESS SPECIFIED) <table border="1"> <tr><th colspan="2">mm</th><th colspan="2">INCH</th></tr> <tr><td>4 PLACES</td><td>± ---</td><td>± ---</td><td>± ---</td></tr> <tr><td>3 PLACES</td><td>± ---</td><td>± ---</td><td>± ---</td></tr> <tr><td>2 PLACES</td><td>± 0.15</td><td>± ---</td><td>± ---</td></tr> <tr><td>1 PLACE</td><td>± 0.25</td><td>± ---</td><td>± ---</td></tr> </table>	mm		INCH		4 PLACES	± ---	± ---	± ---	3 PLACES	± ---	± ---	± ---	2 PLACES	± 0.15	± ---	± ---	1 PLACE	± 0.25	± ---	± ---	DIMENSION STYLE MM ONLY DRAWN BY DATE JONIAK 2008/07/09 CHECKED BY DATE JONIAK 2008/07/09 APPROVED BY DATE SMILLER 2010/03/09	SCALE 1:1 DESIGN UNITS METRIC THIRD ANGLE PROJECTION	TITLE VHDM H-SERIES 6 ROW OPEN END BACKPLANE
	mm		INCH																						
	4 PLACES	± ---	± ---	± ---																					
	3 PLACES	± ---	± ---	± ---																					
2 PLACES	± 0.15	± ---	± ---																						
1 PLACE	± 0.25	± ---	± ---																						
DRAFT WHERE APPLICABLE MUST REMAIN WITHIN DIMENSIONS	MATERIAL NO. SEE TABLES	MOLEX INCORPORATED DOCUMENT NO. SD-76763-001	SHEET NO. 2 OF 2																						
THIS DRAWING CONTAINS INFORMATION THAT IS PROPRIETARY TO MOLEX INCORPORATED AND SHOULD NOT BE USED WITHOUT WRITTEN PERMISSION																									
SIZE C																									