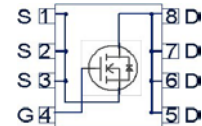

OptiMOS™3 M-Series Power-MOSFET
Features C-Series

- Optimized for 5V driver application (Notebook, VGA, POL)
- Low FOM_{SW} for High Frequency SMPS
- 100% Avalanche tested
- N-channel
- Very low on-resistance $R_{DS(on)}$ @ $V_{GS}=4.5\text{ V}$
- Excellent gate charge $\times R_{DS(on)}$ product (FOM)
- Qualified for consumer level application
- Pb-free plating; RoHS compliant
- Halogen-free according to IEC61249-2-21

Product Summary

V_{DS}		30	V
$R_{DS(on),max}$	$V_{GS}=10\text{ V}$	3.8	mΩ
	$V_{GS}=4.5\text{ V}$	4.7	
I_D		21	A

PG-DSO-8

Type	Package	Marking
BSO038N03MSC G	PG-DSO-8	038N03MSC

Maximum ratings, at $T_j=25\text{ °C}$, unless otherwise specified

Parameter	Symbol	Conditions	Value		Unit
			10 secs	steady state	
Continuous drain current ¹⁾	I_D	$V_{GS}=10\text{ V}, T_A=25\text{ °C}$	21	16	A
		$V_{GS}=10\text{ V}, T_A=90\text{ °C}$	14.3	11.3	
		$V_{GS}=4.5\text{ V}, T_A=25\text{ °C}$	19	15.0	
		$V_{GS}=4.5\text{ V}, T_A=90\text{ °C}$	13.0	10	
Pulsed drain current ²⁾	$I_{D,pulse}$	$T_A=25\text{ °C}$	147		
Avalanche current, single pulse ³⁾	I_{AS}	$T_A=25\text{ °C}$	21		
Avalanche energy, single pulse	E_{AS}	$I_D=21\text{ A}, R_{GS}=25\text{ Ω}$	145		mJ
Gate source voltage	V_{GS}		±20		V
Power dissipation ¹⁾	P_{tot}	$T_A=25\text{ °C}$	2.5	1.56	W
Operating and storage temperature	T_j, T_{stg}		-55 ... 150		°C
IEC climatic category; DIN IEC 68-1			55/150/56		

Parameter	Symbol	Conditions	Values			Unit
			min.	typ.	max.	

Thermal characteristics

Thermal resistance, junction - soldering point	R_{thJS}		-	-	35	K/W
Thermal resistance, junction - ambient	R_{thJA}	minimal footprint, $t_p \leq 10$ s	-	-	110	
		minimal footprint, steady state	-	-	150	
		6 cm ² cooling area ¹⁾ , $t_p \leq 10$ s	-	-	50	
		6 cm ² cooling area ¹⁾ , steady state	-	-	80	

Electrical characteristics, at $T_j = 25$ °C, unless otherwise specified
Static characteristics

Drain-source breakdown voltage	$V_{(BR)DSS}$	$V_{GS} = 0$ V, $I_D = 1$ mA	30	-	-	V
Gate threshold voltage	$V_{GS(th)}$	$V_{DS} = V_{GS}$, $I_D = 250$ μ A	1	-	2	
Zero gate voltage drain current	I_{DSS}	$V_{DS} = 30$ V, $V_{GS} = 0$ V, $T_j = 25$ °C	-	0.1	10	μ A
		$V_{DS} = 30$ V, $V_{GS} = 0$ V, $T_j = 125$ °C	-	10	100	
Gate-source leakage current	I_{GSS}	$V_{GS} = 16$ V, $V_{DS} = 0$ V	-	10	100	nA
Drain-source on-state resistance	$R_{DS(on)}$	$V_{GS} = 4.5$ V, $I_D = 19$ A	-	3.8	4.7	m Ω
		$V_{GS} = 10$ V, $I_D = 21$ A	-	3.2	3.8	
Gate resistance	R_G		-	1.5	-	Ω
Transconductance	g_{fs}	$ V_{DS} > 2 I_D R_{DS(on)max}$, $I_D = 21$ A	40	81	-	S

¹⁾ Device on 40 mm x 40 mm x 1.5 mm epoxy PCB FR4 with 6 cm² (one layer, 70 μ m thick) copper area for drain connection. PCB is vertical in still air.

²⁾ See figure 3 for more detailed information

³⁾ See figure 13 for more detailed information

Parameter	Symbol	Conditions	Values			Unit
			min.	typ.	max.	

Dynamic characteristics

Input capacitance	C_{iss}	$V_{GS}=0\text{ V}, V_{DS}=15\text{ V},$ $f=1\text{ MHz}$	-	4300	5700	pF
Output capacitance	C_{oss}		-	1200	1600	
Reverse transfer capacitance	C_{rss}		-	88	-	
Turn-on delay time	$t_{d(on)}$	$V_{DD}=15\text{ V}, V_{GS}=4.5\text{ V},$ $I_D=21\text{ A}, R_G=1.6\ \Omega$	-	18.1	-	ns
Rise time	t_r		-	9	-	
Turn-off delay time	$t_{d(off)}$		-	25.0	-	
Fall time	t_f		-	9.2	-	

Gate Charge Characteristics⁴⁾

Gate to source charge	Q_{gs}	$V_{DD}=15\text{ V}, I_D=21\text{ A},$ $V_{GS}=0\text{ to }4.5\text{ V}$	-	11.3	-	nC
Gate charge at threshold	$Q_{g(th)}$		-	6.8	-	
Gate to drain charge	Q_{gd}		-	5.8	-	
Switching charge	Q_{sw}		-	10.4	-	
Gate charge total	Q_g		-	26.7	36	
Gate plateau voltage	$V_{plateau}$		-	2.7	-	
Gate charge total	Q_g	$V_{DD}=15\text{ V}, I_D=21\text{ A},$ $V_{GS}=0\text{ to }10\text{ V}$	-	55	73	nC
Gate charge total, sync. FET	$Q_{g(sync)}$	$V_{DS}=0.1\text{ V},$ $V_{GS}=0\text{ to }4.5\text{ V}$	-	23.1	-	
Output charge	Q_{oss}	$V_{DD}=15\text{ V}, V_{GS}=0\text{ V}$	-	31.8	-	

Reverse Diode

Diode continuous forward current	I_S	$T_A=25\text{ }^\circ\text{C}$	-	-	3.1	A
Diode pulse current	$I_{S,pulse}$		-	-	147	
Diode forward voltage	V_{SD}	$V_{GS}=0\text{ V}, I_F=21\text{ A},$ $T_j=25\text{ }^\circ\text{C}$	-	0.83	-	V
Reverse recovery charge	Q_{rr}	$V_R=15\text{ V}, I_F=I_S,$ $di_F/dt=400\text{ A}/\mu\text{s}$	-	-	tbd	nC

⁴⁾ See figure 16 for gate charge parameter definition

1 Power dissipation

$P_{tot} = f(T_A); t_p \leq 10 \text{ s}$

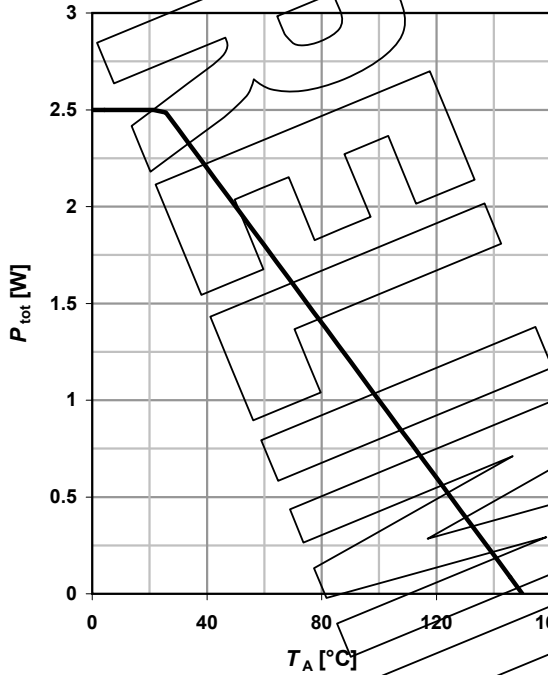

2 Drain current

$I_D = f(T_A); t_p \leq 10 \text{ s}$

parameter: V_{GS}

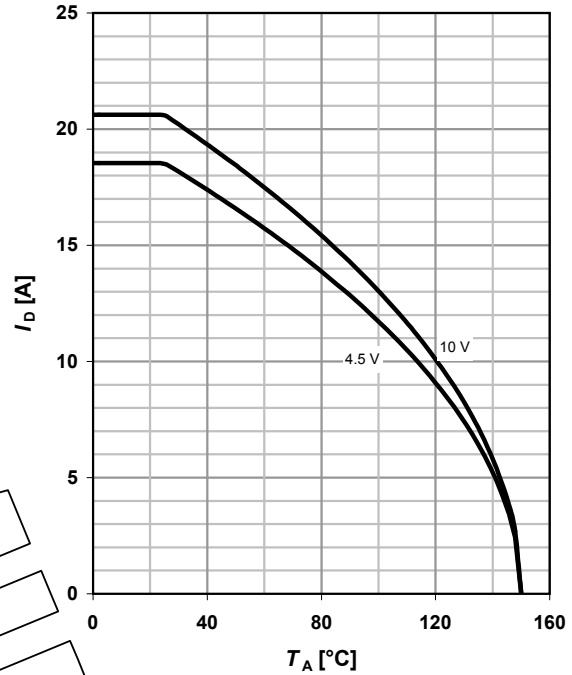

3 Safe operating area

$I_D = f(V_{DS}); T_A = 25 \text{ °C}^2; D = 0$

parameter: t_p

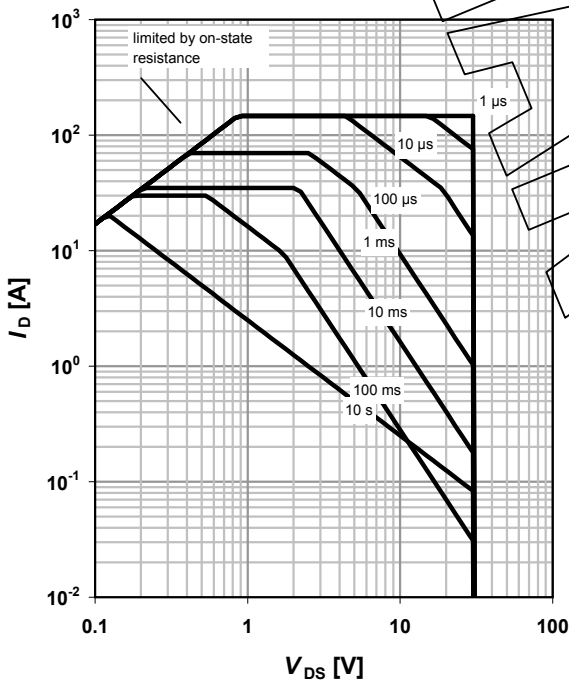

4 Max. transient thermal impedance

$Z_{thJA} = f(t_p)$

parameter: $D = t_p / T$

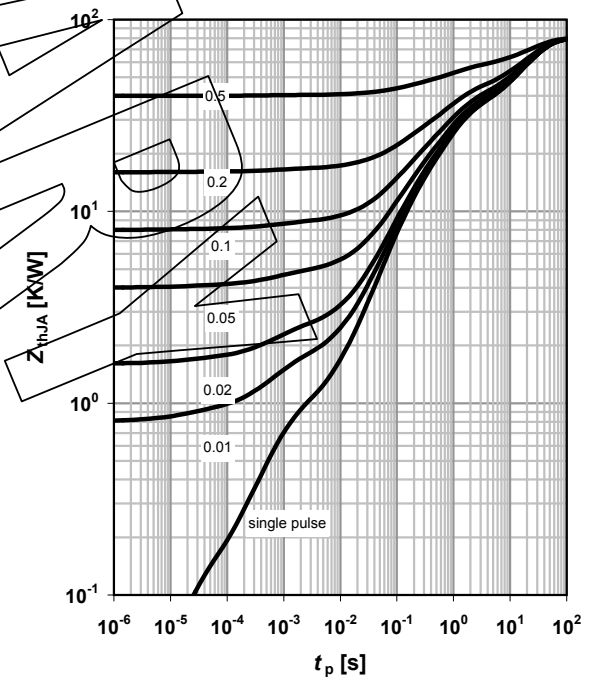

5 Typ. output characteristics

$I_D = f(V_{DS}); T_j = 25^\circ\text{C}$

parameter: V_{GS}

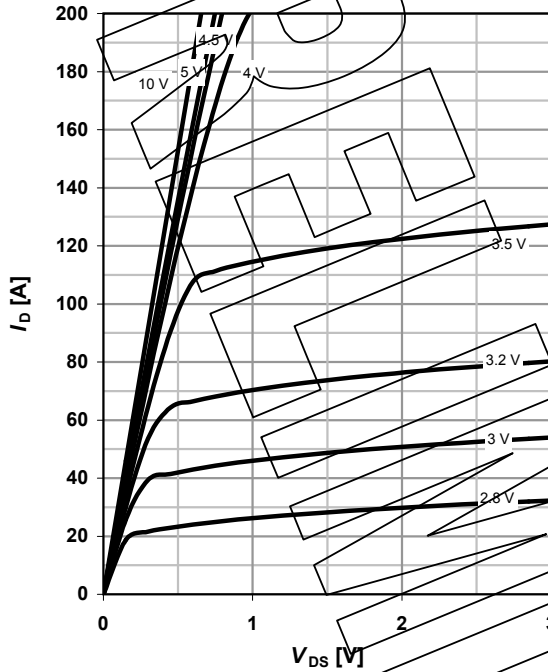

6 Typ. drain-source on resistance

$R_{DS(on)} = f(I_D); T_j = 25^\circ\text{C}$

parameter: V_{GS}

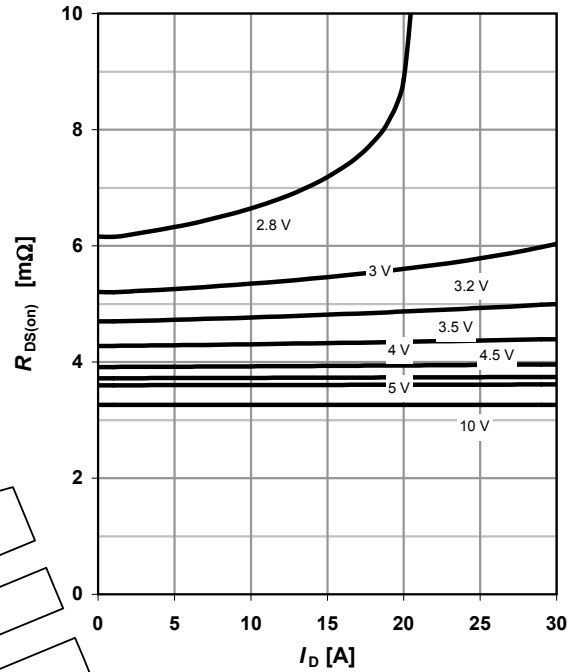

7 Typ. transfer characteristics

$I_D = f(V_{GS}); |V_{DS}| > 2|I_D|R_{DS(on)max}$

parameter: T_j

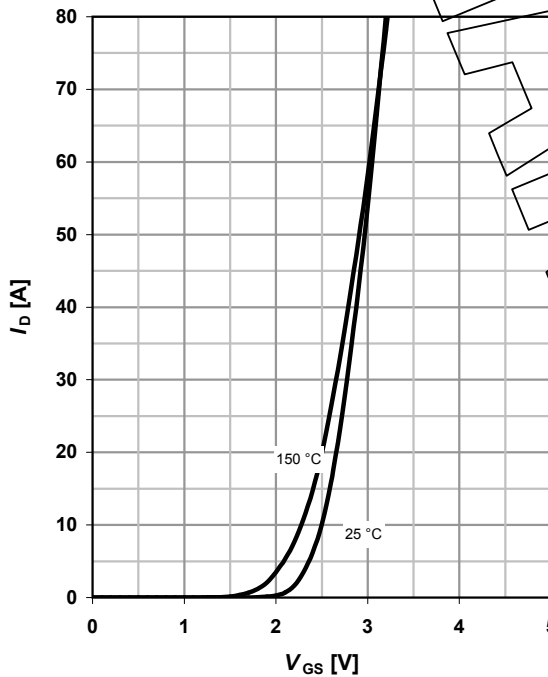

8 Typ. forward transconductance

$g_{fs} = f(I_D); T_j = 25^\circ\text{C}$

parameter: V_{GS}

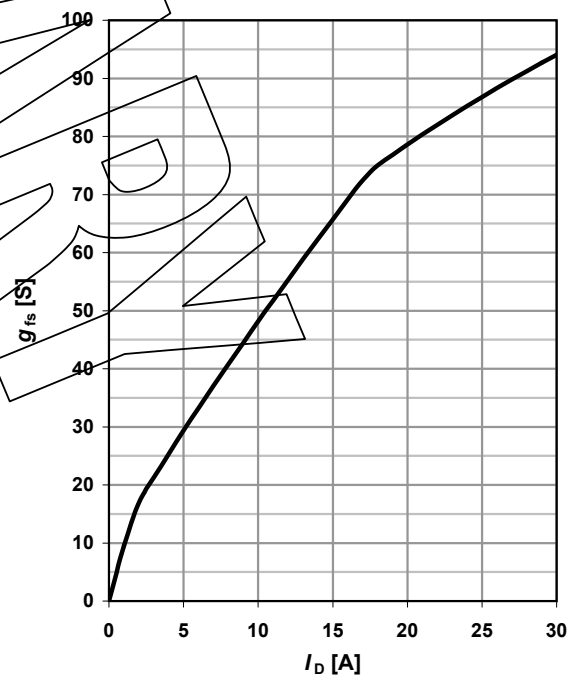

9 Drain-source on-state resistance

$R_{DS(on)} = f(T_j); I_D = 21 \text{ A}, V_{GS} = 10 \text{ V}$

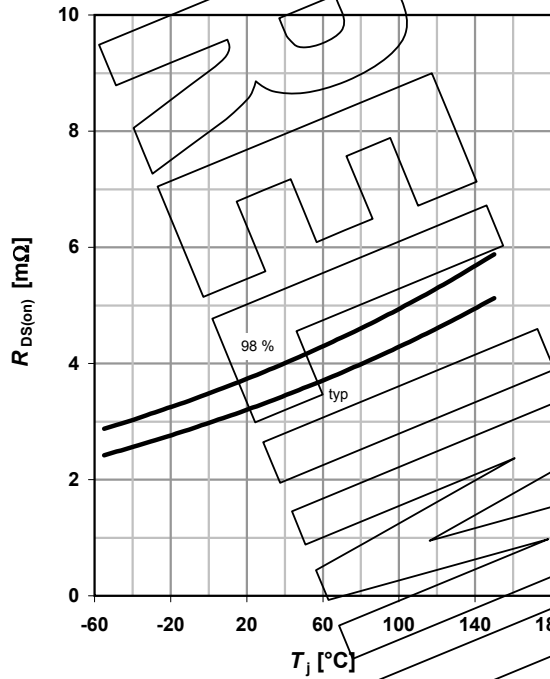

10 Typ. gate threshold voltage

$V_{GS(th)} = f(T_j); V_{GS} = V_{DS}; I_D = 250 \mu\text{A}$

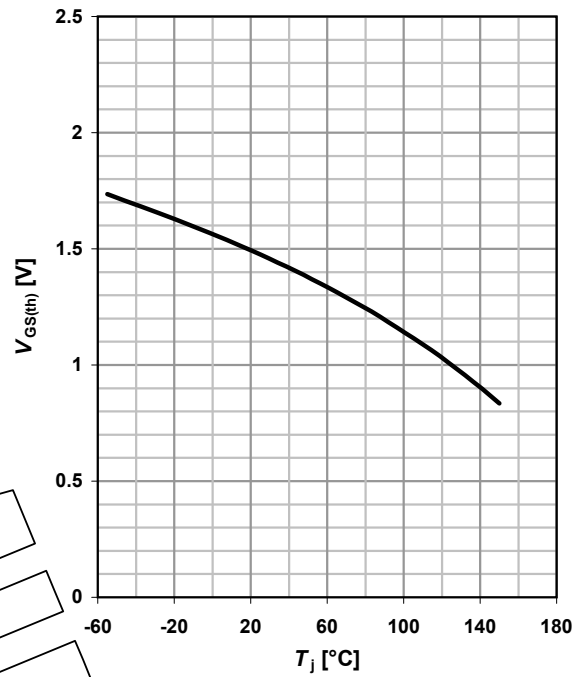

11 Typ. capacitances

$C = f(V_{DS}); V_{GS} = 0 \text{ V}; f = 1 \text{ MHz}$

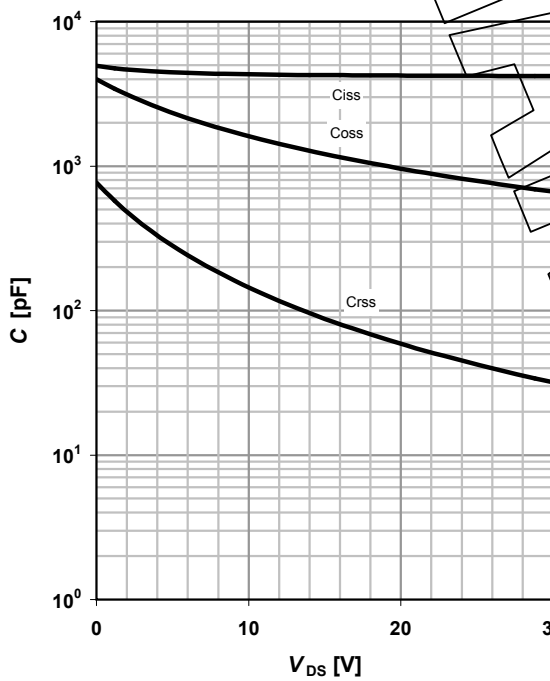

12 Forward characteristics of reverse diode

$I_F = f(V_{SD})$

parameter: T_j

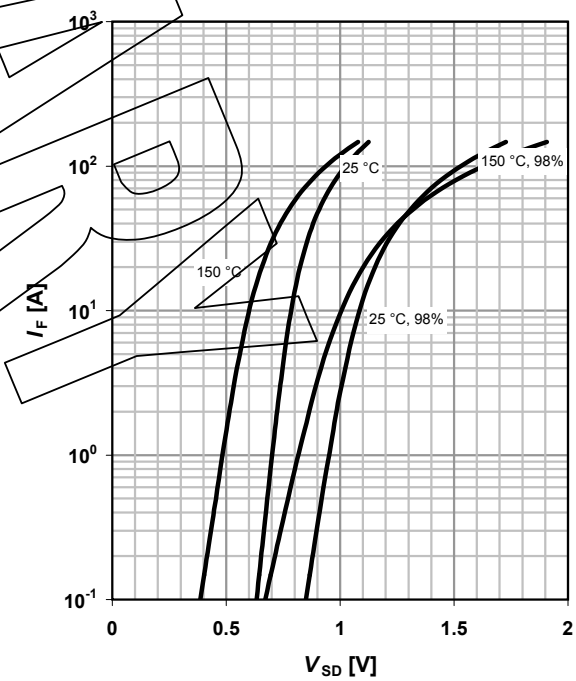

13 Avalanche characteristics

$I_{AS} = f(t_{AV}); R_{GS} = 25 \Omega$

parameter: $T_{j(start)}$

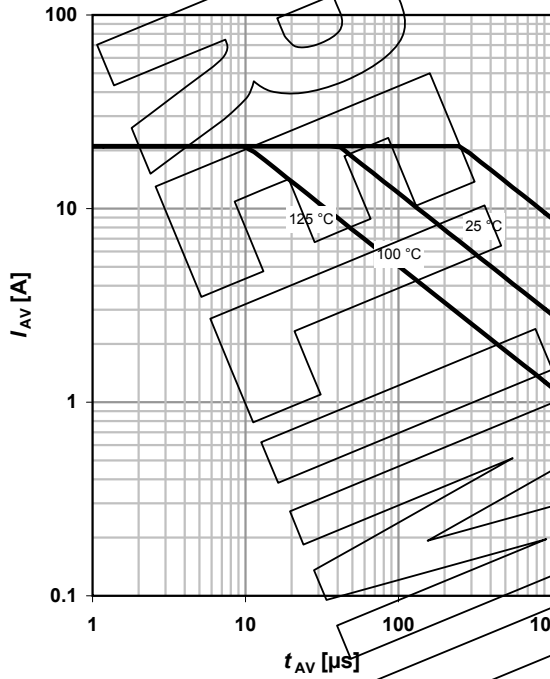

14 Typ. gate charge

$V_{GS} = f(Q_{gate}); I_D = 12.1 \text{ A pulsed}$

parameter: V_{DD}

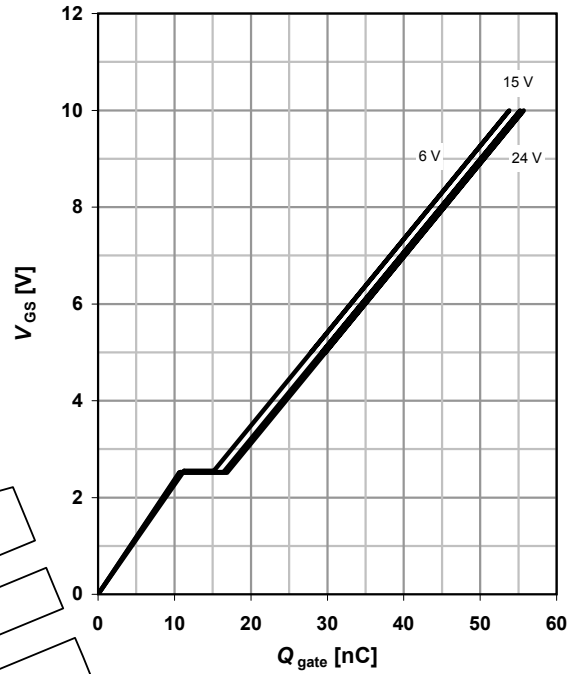

15 Drain-source breakdown voltage

$V_{BR(DSS)} = f(T_j); I_D = 1 \text{ mA}$

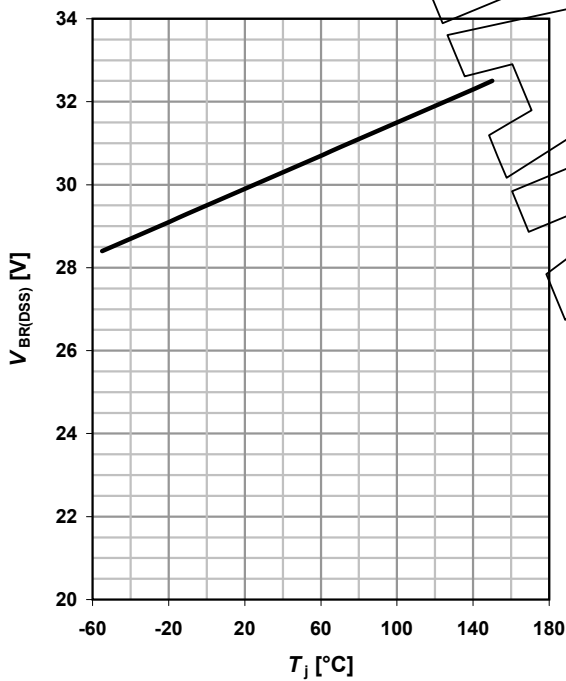

16 Gate charge waveforms

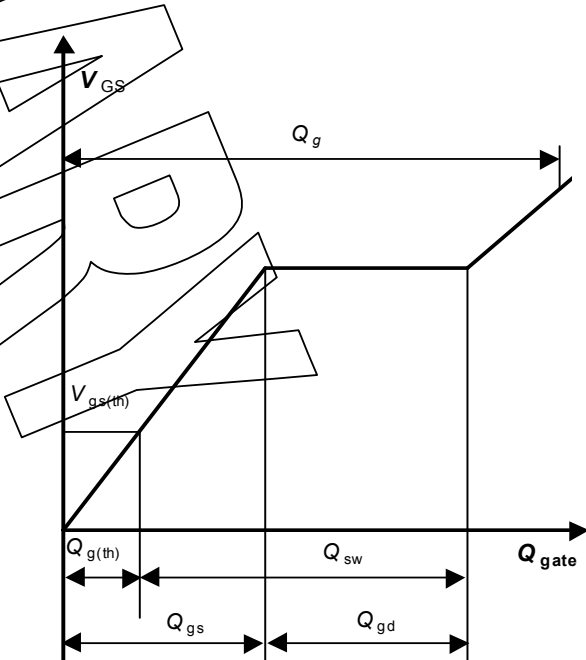

Package Outline

PG-DSO-8: Outline



1) DOES NOT INCLUDE MOLD FLASH OR PROTRUSIONS.

DIM	MILLIMETERS		INCHES	
	MIN	MAX	MIN	MAX
A	-	1.75	-	0.069
A1	0.10	-	0.004	-
A2	1.25	1.65	0.049	0.065
b	0.35	0.51	0.014	0.020
c	0.17	0.25	0.007	0.010
D	4.80	5.00	0.189	0.197
E	5.80	6.20	0.228	0.244
E1	3.80	4.00	0.150	0.157
e	1.27		0.050	
N	8		8	
L	0.39	0.89	0.015	0.035
h	0.23	0.50	0.009	0.020
θ	0°	8°	0°	8°
θ ₁	-	19°	-	19°
ccc	0.10		0.004	
ddd	0.25		0.010	
F1	5.59	5.79	0.220	0.228
F2	0.55	0.75	0.022	0.030
F3	1.21	1.41	0.048	0.056

DOCUMENT NO.
Z8B00003333

SCALE

EUROPEAN PROJECTION

ISSUE DATE
09.01.2008

REVISION
02

Published by
Infineon Technologies AG
81726 Munich, Germany
© 2008 Infineon Technologies AG
All Rights Reserved.

Legal Disclaimer

The information given in this document shall in no event be regarded as a guarantee of conditions or characteristics. With respect to any examples or hints given herein, any typical values stated herein and/or any information regarding the application of the device, Infineon Technologies hereby disclaims any and all warranties and liabilities of any kind, including without limitation, warranties of non-infringement of intellectual property rights of any third party.

Information

For further information on technology, delivery terms and conditions and prices, please contact the nearest Infineon Technologies Office (www.infineon.com).

Warnings

Due to technical requirements, components may contain dangerous substances. For information on the types in question, please contact the nearest Infineon Technologies Office. Infineon Technologies components may be used in life-support devices or systems only with the express written approval of Infineon Technologies, if a failure of such components can reasonably be expected to cause the failure of that life-support device or system or to affect the safety or effectiveness of that device or system. Life support devices or systems are intended to be implanted in the human body or to support and/or maintain and sustain and/or protect human life. If they fail, it is reasonable to assume that the health of the user or other persons may be endangered.