

SPECIFICATIONS

Electrical Ratings	3A @ 120 VAC, 28VDC; 1A @ 250VAC
Electrical Life	50,000 cycles typical
Contact Resistance	< 20 mΩ max initial @ 2-4VDC, 100mA
Dielectric Strength	1500Vrms min
Actuator Travel	.85mm +/- .2mm
Insulation Resistance	> 100MΩ min
Operating Temperature	-40°C to 85°C
Storage Temperature	-40°C to 85°C



MATERIALS ←RoHS COMPLIANT





Actuator	6/6 Nylon, Glass Filled
Housing	DAP – Diallyl Phthalate
Cover	Stainless Steel
Bushing	Brass, Nickel Plated
Contacts	Brass, Silver Plated
Terminals	Brass, Silver Plated



UL US - E222871

ORDERING INFORMATION

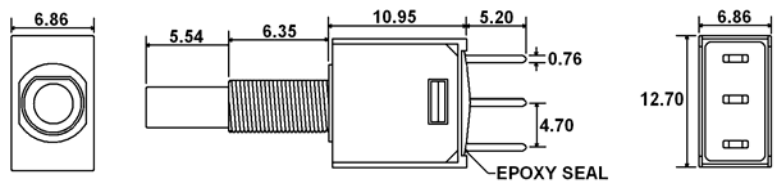
Series:	ANP	2	1	F4	C	Q	E	C742
<p>ANP</p> <p>Number of Poles: 1 = SPDT 2 = DPDT</p> <p>Switch Function: 1 = ON - (ON) 2 = ON – ON (Latching)</p> <p>Bushing: F4 / N4 = ¼-40NS / Non-Threaded, Keyway, 6.35mm F9 / N9 = ¼-40NS / Non-Threaded, Flat, 6.35mm <i>**No bushing is selected if a panel mount frame is selected below</i></p> <p>Terminals: B = Solder Lug C = PC Pin D = Quick Connect H = Horizontal Mount, Right Angle PC Pin; <i>HS = Snap-in</i> V = Vertical Mount, Right Angle PC Pin S20 = PC Pin with Support Bracket; <i>V20 = Snap-in Support Bracket</i> S25 = PC Pin with Support Bracket; <i>V25 = Snap-in Support Bracket</i> S40 = PC Pin with Support Bracket; <i>V40 = Snap-in Support Bracket</i></p> <p>Contacts: Q = Silver Plated R = Gold Plated G = Gold over Silver Plated</p> <p>Epoxy Seal: E = Epoxy Seal</p> <p>Actuator Cap / Frame: Blank = None C73 F75 = Snap-in Panel Mount w/ Frame C74 F76 = Snap-in Panel Mount w/ Frame C75 L75 = Snap-in Panel Mount w/ Frame and LED C76 L76 = Snap-in Panel Mount w/ Frame and LED C77</p> <p>Actuator Cap / Frame Colors: <i>** See Cap Options for color availability</i></p>								

SWITCH FUNCTION

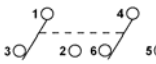
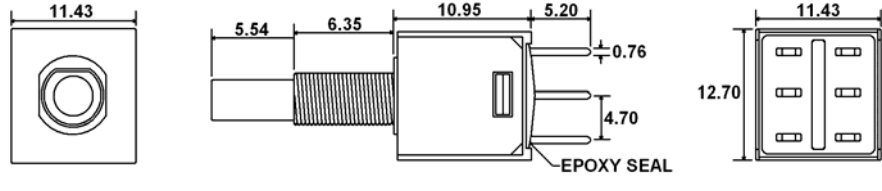
 SPDT 	Function	Toggle Position		
				
	1	ON	(ON)	
	2	ON	ON	
Terminals	1-3	1-2		

 DPDT 	Function	Toggle Position		
				
	1	ON	(ON)	
	2	ON	ON	
Terminals	1-3 4-6	1-2 4-5		

BUSHING OPTIONS

PANEL MOUNTING

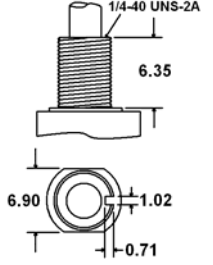
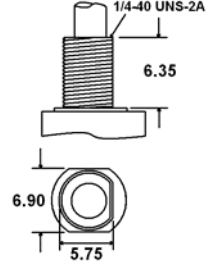
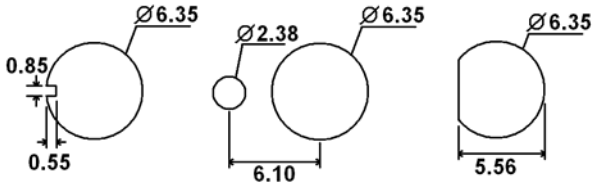
 F4 (Threaded) N4 (Non-Threaded)	 F9 (Threaded) N9 (Non-Threaded)	 1/4" - 40 Bushings
--	--	---

TERMINAL OPTIONS

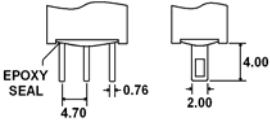
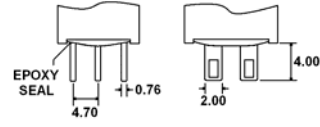
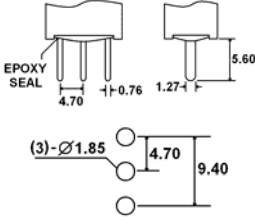
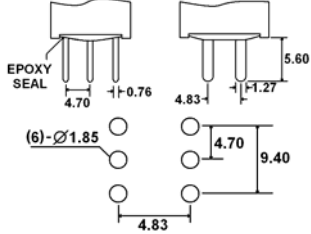
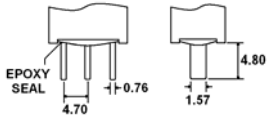
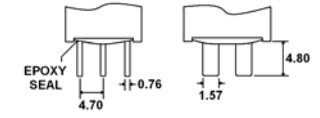
 B (Single Pole)	 B (Double Pole)	 C (Single Pole)	 C (Double Pole)
 D (Single Pole)	 D (Double Pole)		

TERMINAL OPTIONS

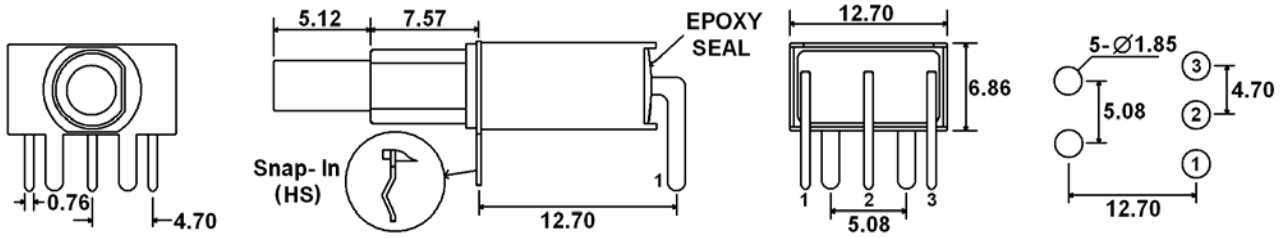

H (HS – Snap-in) = Horizontal Mount, Right Angle PC Pins (Single Pole)

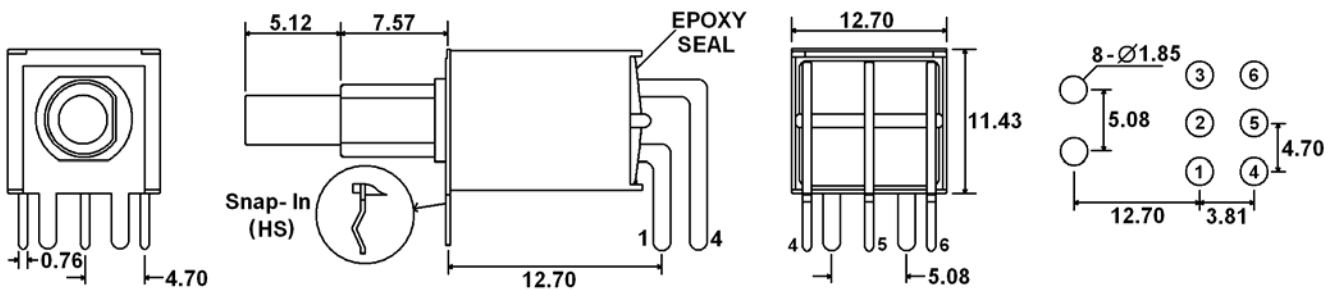

H (HS – Snap-in) = Horizontal Mount, Right Angle PC Pins (Double Pole)

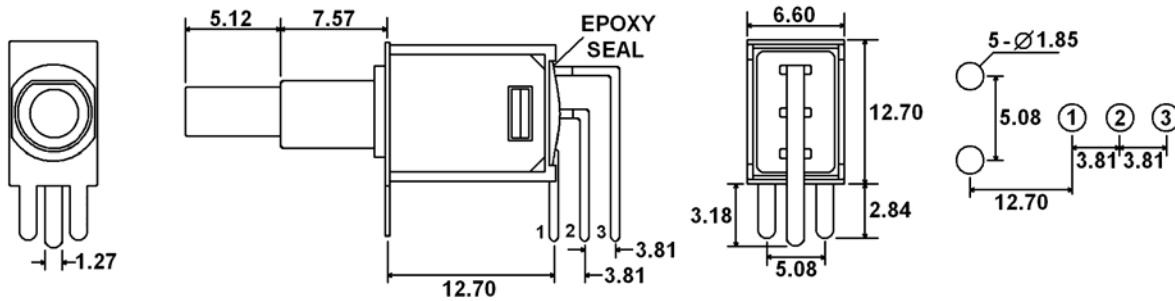

V = Vertical Mount, Right Angle PC Pins (Single Pole)

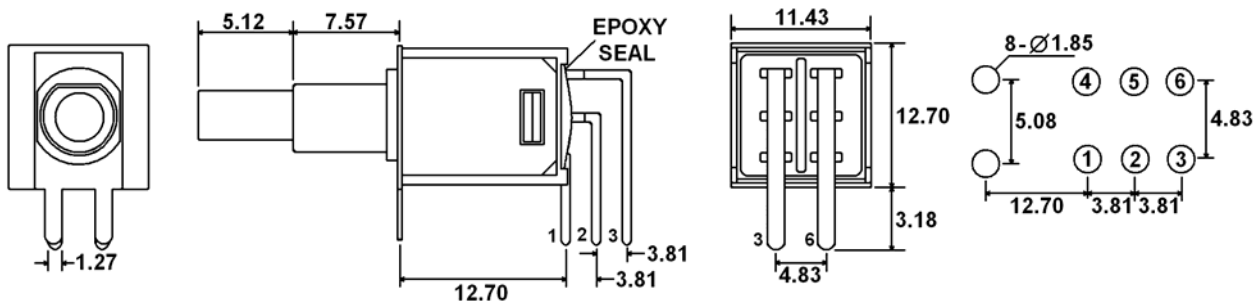

V = Vertical Mount, Right Angle PC Pins (Double Pole)

TERMINAL OPTIONS

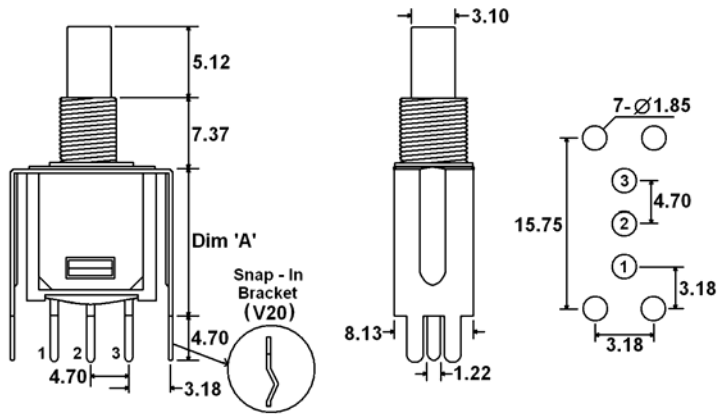

Terminal Option	"A" Dimension
S20-V20	11.68
S25-V25	16.00

S20/S25 (V20/V25 – Snap-in Bracket) = PC Pins with Support Bracket (Single Pole)

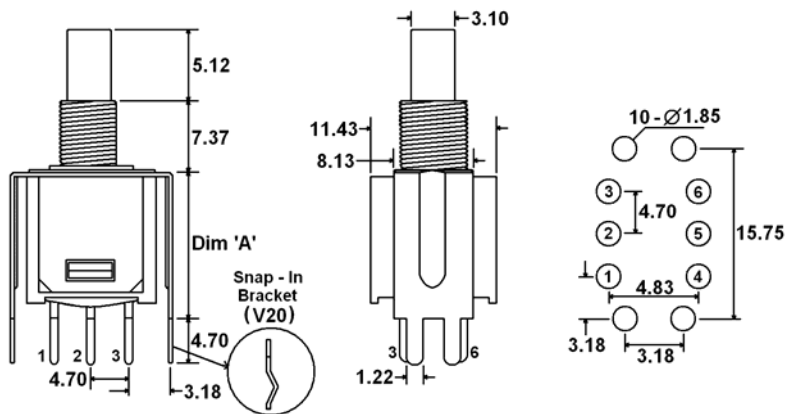

Terminal Option	"A" Dimension
S20-V20	11.68
S25-V25	16.00

S20/S25 (V20/V25 – Snap-in Bracket) = PC Pins with Support Bracket (Double Pole)

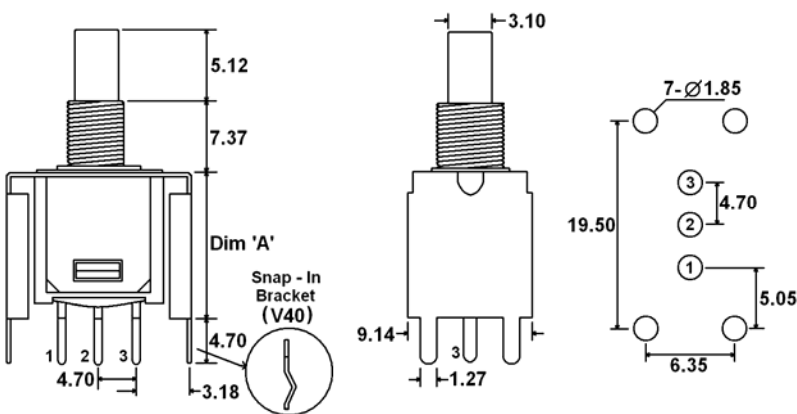

Terminal Option	"A" Dimension
S40-V40	16.00

S40 (V40 – Snap-in Bracket) = PC Pins with Support Bracket (Single Pole)

TERMINAL OPTIONS

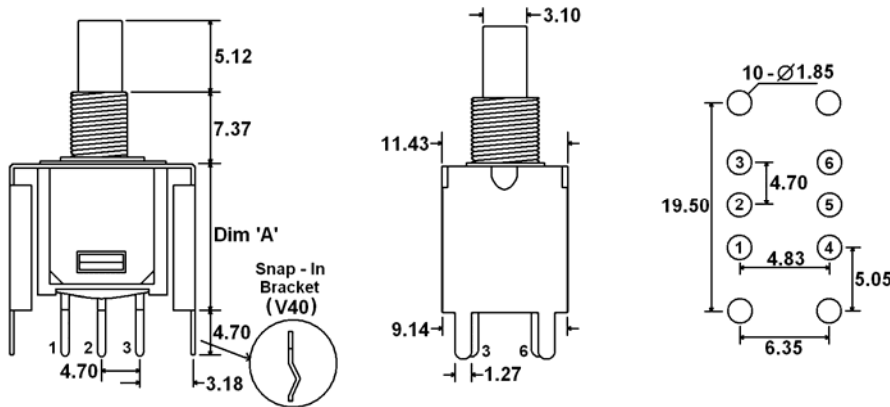

Terminal Option	"A" Dimension
S40-V40	16.00

S40 (V40 – Snap-in Bracket) = PC Pins with Support Bracket (Double Pole)

CONTACT OPTIONS

Designator	Contact Material	Terminal Material	Electrical Ratings
Q	Silver Plating	Silver Plating	3A @ 120 VAC, 28VDC; 1A @ 250VAC
R	Gold over Nickel Plating	Gold over Nickel Plating	.4 VA max @ 20VAC or VDC max
G	Gold over Silver Plating	Gold over Silver Plating	.4 VA max @ 20VAC or VDC max or 3A @ 120 VAC, 28VDC; 1A @ 250VAC

CAP OPTIONS

<p>C73_ 1 = White, 2 = Black, 3 = Red Contact Factory for other available colors</p>	<p>C74_ 1 = White, 2 = Black, 3 = Red Contact Factory for other available colors</p>	<p>C75_ 1 = White, 2 = Black, 3 = Red Contact Factory for other available colors</p>
<p>C76_ 1 = White, 2 = Black, 3 = Red Contact Factory for other available colors</p>	<p>C77_ 1 = White, 2 = Black, 3 = Red Contact Factory for other available colors</p>	

FRAME OPTIONS

F75__ ← (Insert Cap & Frame Colors Here)

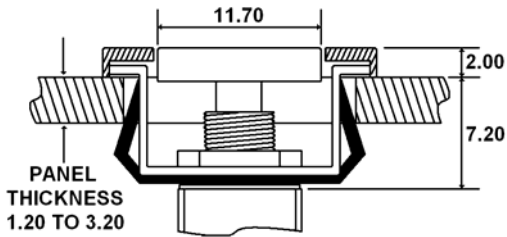

Cap Color / Frame Color: 1 = White, 2 = Black, 3 = Red

Increase the length dimension to 15.75/15.88 for 1.5/3.2 thick panels

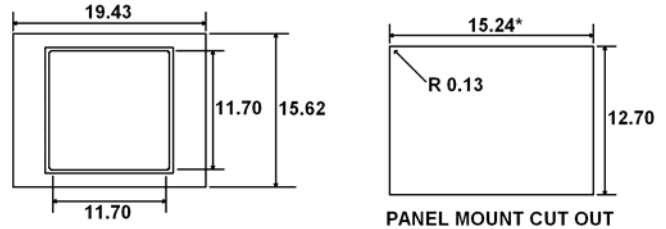

**Contact factory for other available colors

F76__ ← (Insert Cap & Frame Colors Here)

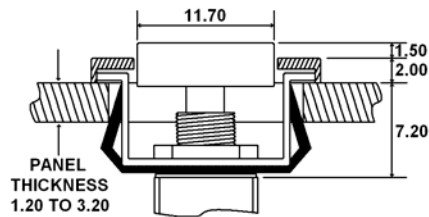

Cap Color / Frame Color: 1 = White, 2 = Black, 3 = Red

Increase the length dimension to 15.75/15.88 for 1.5/3.2 thick panels

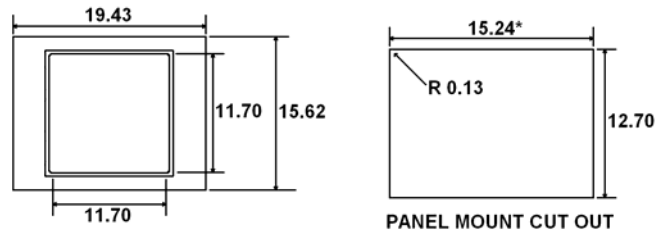

**Contact factory for other available colors

L75__ ← (Insert Cap, Frame & LED Colors Here)

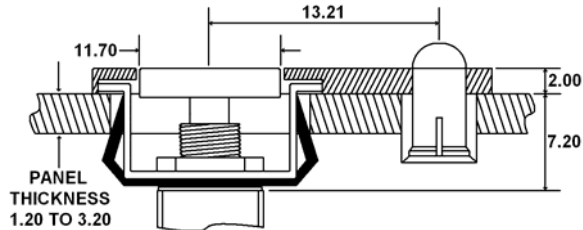

Cap Color / Frame Color: 1 = White, 2 = Black, 3 = Red

Increase the length dimension to 15.75/15.88 for 1.5/3.2 thick panels

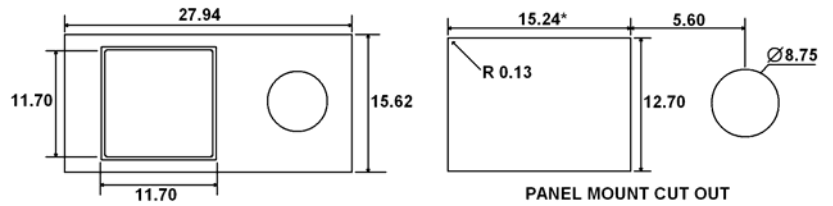

**Contact factory for other available colors

L76__ ← (Insert Cap, Frame & LED Colors Here)

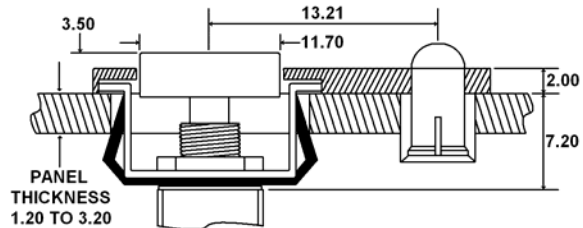

Cap Color / Frame Color: 1 = White, 2 = Black, 3 = Red
 LED Color R = Red, Y = Yellow, G = Green

Increase the length dimension to 15.75/15.88 for 1.5/3.2 thick panels

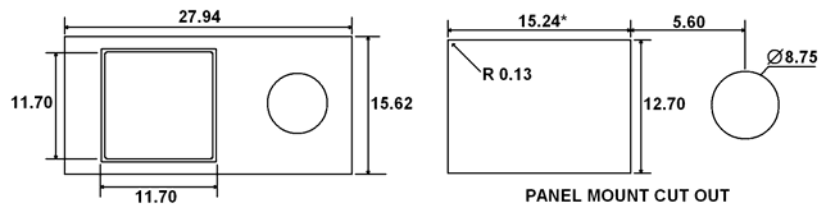

**Contact factory for other available colors

HARDWARE **Two hex nuts, one lock washer, & one locking ring supplied standard with threaded bushings

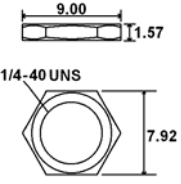
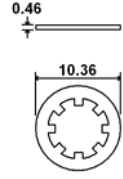
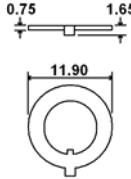
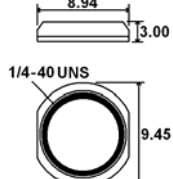
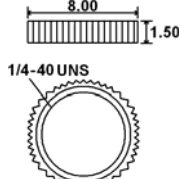
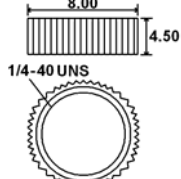
 <p>Hex Nut</p>	 <p>Lock Washer</p>	 <p>Locking Ring</p>	 <p>Dress Nut</p>	 <p>Knurled Nut</p>	 <p>Knurled Nut</p>
---	---	--	--	---	---

**For use with F4 bushings

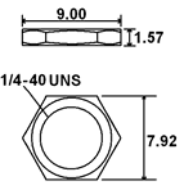
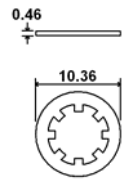
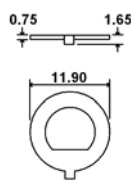
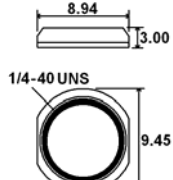
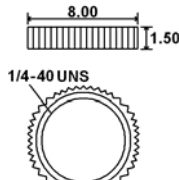
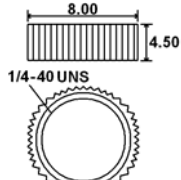
 <p>Hex Nut</p>	 <p>Lock Washer</p>	 <p>Locking Ring</p>	 <p>Dress Nut</p>	 <p>Knurled Nut</p>	 <p>Knurled Nut</p>
---	---	--	--	---	---

**For use with F9 bushings

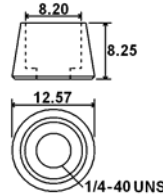
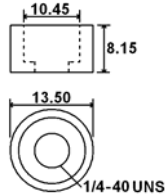
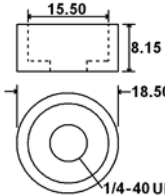
 <p>Cap Shroud A</p>	 <p>Cap Shroud B</p>	 <p>Cap Shroud C</p>
---	---	---