

**PLEASE CHECK WWW.MOLEX.COM FOR LATEST PART INFORMATION**

**Part Number:** [0366380007](#)  
**Status:** **Active**  
**Overview:** [cmc connectors](#)  
**Description:** 2.50mm (.098"), 3.50mm (.138") CMC Header, Right Angle, 48 Position, 36 loaded, 1 Port, Brown, Peg, Lead-free

**Documents:**

[3D Model](#) [RoHS Certificate of Compliance \(PDF\)](#)  
[Drawing \(PDF\)](#)

**General**

Product Family	PCB Headers
Series	<a href="#">36638</a>
Application	Wire-to-Board
Overview	<a href="#">cmc connectors</a>
Product Name	CMC

**Physical**

Breakaway	No
Circuits (Loaded)	36
Circuits (maximum)	48
Circuits Detail	6 x 1.5mm & 30 x 0.635mm terminals
Color - Resin	Black
Durability (mating cycles max)	20
First Mate / Last Break	Yes
Glow-Wire Compliant	No
Guide to Mating Part	Yes
Keying to Mating Part	Yes
Lock to Mating Part	Yes
Mated Height (in)	0.264 In
Mated Height (mm)	6.70 mm
Material - Metal	Brass
Material - Plating Mating	Tin
Material - Plating Termination	Tin
Material - Resin	Polyester
Number of Rows	4
Orientation	Right Angle
PC Tail Length (in)	0.114 In
PC Tail Length (mm)	2.90 mm
PCB Locator	Yes
PCB Retention	Yes
PCB Thickness Recommended (in)	0.063 In
PCB Thickness Recommended (mm)	1.60 mm
Packaging Type	Tray
Pitch - Mating Interface (in)	0.098 In, 0.138 In, 0.146 In
Pitch - Mating Interface (mm)	2.50 mm, 3.50 mm, 3.70 mm
Pitch - Term. Interface (in)	0.098 In, 0.138 In, 0.146 In
Pitch - Term. Interface (mm)	2.50 mm, 3.50 mm, 3.70 mm
Plating min: Mating (µin)	160
Plating min: Mating (µm)	4
Plating min: Termination (µin)	160
Plating min: Termination (µm)	4
Polarized to Mating Part	Yes
Polarized to PCB	Yes
Shrouded	Closed Ends
Stackable	No

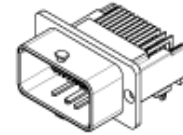

*Series*  
*image - Reference only*

**EU RoHS**

**ELV and RoHS Compliant**  
**REACH SVHC**  
 Not Reviewed  
**Halogen-Free Status**

**China RoHS**



**Not Reviewed**

**Need more information on product environmental compliance?**

Email [productcompliance@molex.com](mailto:productcompliance@molex.com)  
 For a multiple part number RoHS Certificate of Compliance, [click here](#)

Please visit the [Contact Us](#) section for any non-product compliance questions.

**Search Parts in this Series**

[36638Series](#)

**Mates With**

CMC Connectors [643201319](#) , [643203319](#) ,

**Use With**

CMC Connectors [643201319](#) , [643203319](#) , [643202319](#) , [643204319](#). CMC CP Terminals Terminals [64322](#) , [64323](#). CMC Blind Plug for CP Terminal [64325](#). Wire Cap [643191201](#)

Surface Mount Compatible (SMC)	No
Temperature Range - Operating	-40°C to +100°C
Termination Interface: Style	Through Hole

**Electrical**

Current - Maximum per Contact	8A
Voltage - Maximum	250V

**Material Info****Reference - Drawing Numbers**

Packaging Specification	PK-36638-001, PK-36638-002
Sales Drawing	SD-36638-002

This document was generated on 05/24/2010

**PLEASE CHECK [WWW.MOLEX.COM](http://WWW.MOLEX.COM) FOR LATEST PART INFORMATION**

RoHS COMPLIANT

4	1	GRID PLATE	PBT 30% GLASS FILLED	BLACK
3	1	HOUSING		BLACK
2	2	1.5	CuZn30	NICKEL UNDERCOAT: 1.3µM TO 2.2µM
1	10	0.64	CuZn30	MATTE TIN OVERCOAT: 4µM TO 5µM
SL NO.	QTY	DESIGNATION	MATERIAL	FINISH

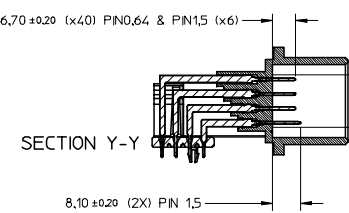
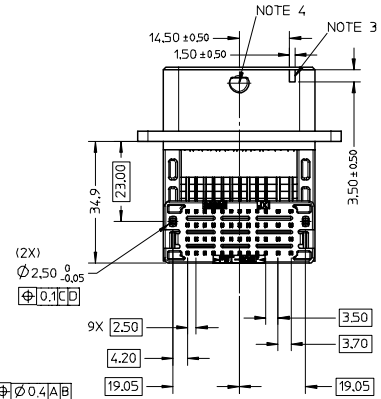
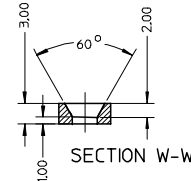
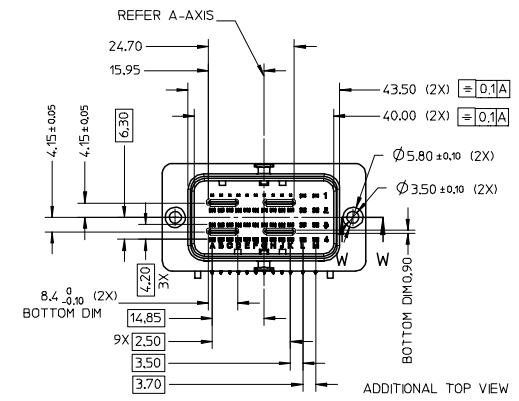
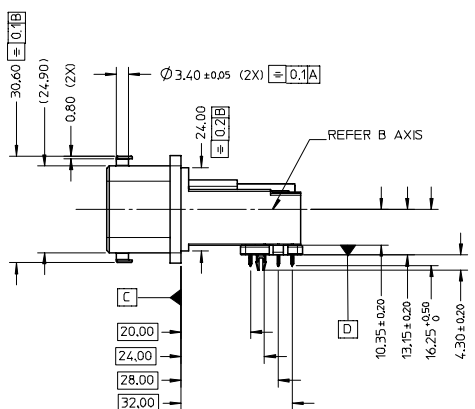
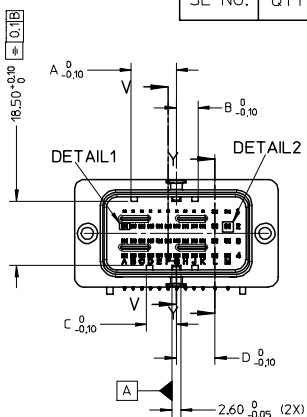
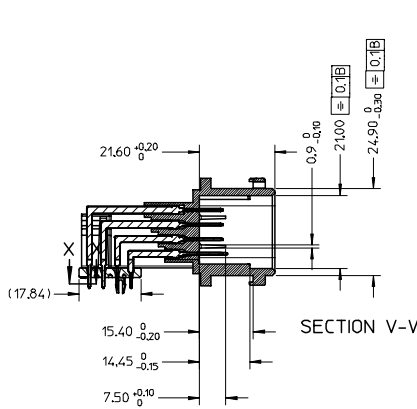
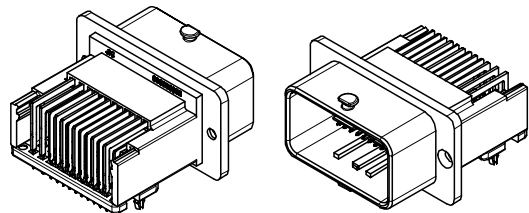

D	6.30	12.90
C	8.50	12.90
B	6.30	10.70
A	12.90	8.50
DIMENSION	366380002	366380003
	366380004	366380005
	366380006	366380007
	366380008	366380009
	(BLACK)	(BROWN)
MOLEX PN		

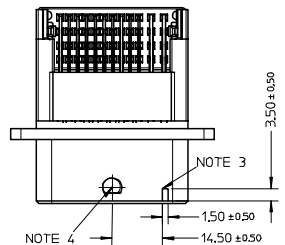
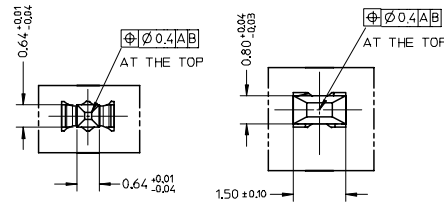

<b>ENTER DESCRIPTION</b> EIC NO: 12008-0132 DRWNR: RANGAPPAO1 2007/09/20 CHKDR: PRASAD 2007/09/21 APPR: KRASAD 2007/09/21	<b>QUALITY SYMBOLS</b> =0 =0	<b>GENERAL TOLERANCES (UNLESS SPECIFIED)</b>		<b>DIMENSION STYLE</b> MM ONLY		SCALE 1:1	DESIGN UNITS METRIC	THIRD ANGLE PROJECTION		
		4 PLACES ± --- ± --- 3 PLACES ± --- ± --- 2 PLACES ± 0.1 ± --- 1 PLACE ± 0.2 ± ---		mm INCH		DRAWN BY DATE ROOPESH 08/05/2006		TITLE CMC HEADER 48/48WAY AND 48/36WAY T3 INTERFACE		
		ANGULAR ± 1 °		DRAFT WHERE APPLICABLE MUST REMAIN WITHIN DIMENSIONS		CHECKED BY DATE DINESH 08/05/2006		MOLEX INCORPORATED		
		SEE TABLE 'A'		MATERIAL NO. SIZE A2		DATE 08/05/2006		DOCUMENT NO. SD-36638-002		SHEET NO. 1 OF 3

TABLE 'A'

ASSY CMC HEADER	ASSY CMC 48 WAY 48 CKT	366380002	BLACK	AVAILABLE (SEE VIEW 'A')	1.6	1.5	L1 & M1,L2 & M2 L3 & M3,L4 & M4
		366380003	BROWN				
		366380004	BLACK	NOT AVAILABLE (SEE VIEW 'B')	0.8/1.6/2.0	0.64	
		366380005	BROWN				
ASSY CMC 48 WAY 36 CKT	ASSY CMC 48 WAY 36 CKT	366380006	BLACK	AVAILABLE (SEE VIEW 'A')	1.6	1.5	L2 & M2 L3 & M3,L4 & M4
		366380007	BROWN				
		366380008	BLACK	NOT AVAILABLE (SEE VIEW 'B')	0.8/1.6/2.0	0.64	
		366380009	BROWN				
DESIGNATION	MOLEX PN	CODING COLOUR	PCB LOCKING ON GRID PLATE	FOR PCB OF THICKNESS	PIN	CAVITIES NUMBER	

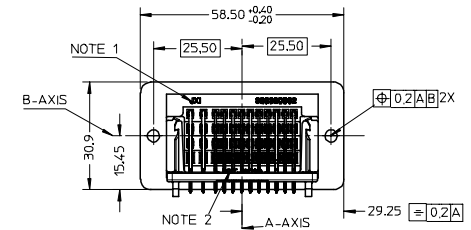
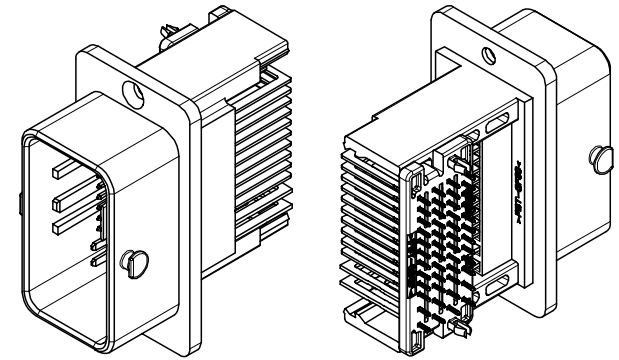

ADDITIONAL BACK VIEW

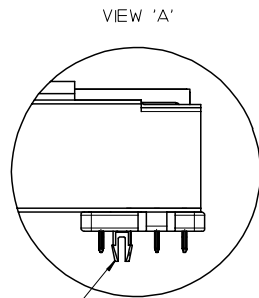
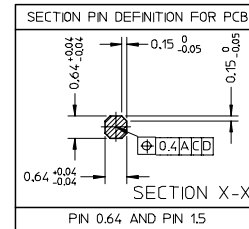

GRID PLATE WITH PCB LOCKING

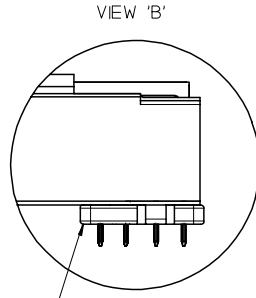

GRID PLATE WITHOUT PCB LOCKING

NOTES :

1. AREA FOR JXI AND MOLEX PART NUMBER REPRESENTATION
2. AREA FOR PLASTIC MATERIAL >PBT-30%GF< DESCRIPTION
3. PAINT WITH WHITE COLOR(RoHS COMPLIANT) AT SPECIFIED TWO AREAS
4. PAINT WITH BROWN COLOR(RoHS COMPLIANT) AT SPECIFIED AREA ON BOTH SIDE FOR PN: 366380003,366380005, 366380007,366380009.
5. PART TO MEET SOLDERABILITY SPEC SMES-152
6. PACKAGING SPECIFICATION PK-36638-002

<b>ENTER DESCRIPTION</b> EIC NO: 12008-0132 DRW:NRANGAPPA01 2007/09/20 CHK:KPRASAD 2007/09/21 APPR:KPRASAD 2007/09/21 REV:	QUALITY SYMBOLS	GENERAL TOLERANCES (UNLESS SPECIFIED)	DIMENSION STYLE	SCALE	DESIGN UNITS	THIRD ANGLE PROJECTION	
	$\nabla=0$ $\nabla=0$	4 PLACES ± --- ± --- 3 PLACES ± --- ± --- 2 PLACES ± 0.1 ± --- ± --- 1 PLACE ± 0.2 ± --- ± --- ANGULAR ± 1 °	mm INCH ± --- ± --- ± 0.1 ± --- ± --- ± 0.2 ± --- ± ---	DIMENSIONAL DATE ROOPESH 08/05/2006 DINESH 08/05/2006 APPROVED BY DATE DINESH 08/05/2006	MOLEXY HOLE SIZE 1.15 DIA METRIC MOLEXY HOLE SIZE 1.15 DIA METRIC MOLEXY HOLE SIZE 1.15 DIA METRIC	MOLEXY HOLE SIZE 1.15 DIA METRIC MOLEXY HOLE SIZE 1.15 DIA METRIC MOLEXY HOLE SIZE 1.15 DIA METRIC	MOLEXY HOLE SIZE 1.15 DIA METRIC MOLEXY HOLE SIZE 1.15 DIA METRIC MOLEXY HOLE SIZE 1.15 DIA METRIC
	DRAFT WHERE APPLICABLE MUST REMAIN WITHIN DIMENSIONS SEE TABLE 'A'	MOLEX INCORPORATED SD-36638-002	SHEET NO. 2 OF 3				
	THIS DRAWING CONTAINS INFORMATION THAT IS PROPRIETARY TO MOLEX INCORPORATED AND SHOULD NOT BE USED WITHOUT WRITTEN PERMISSION						

INTERFACE PCB DEFINITION (SOLDER SIDE)

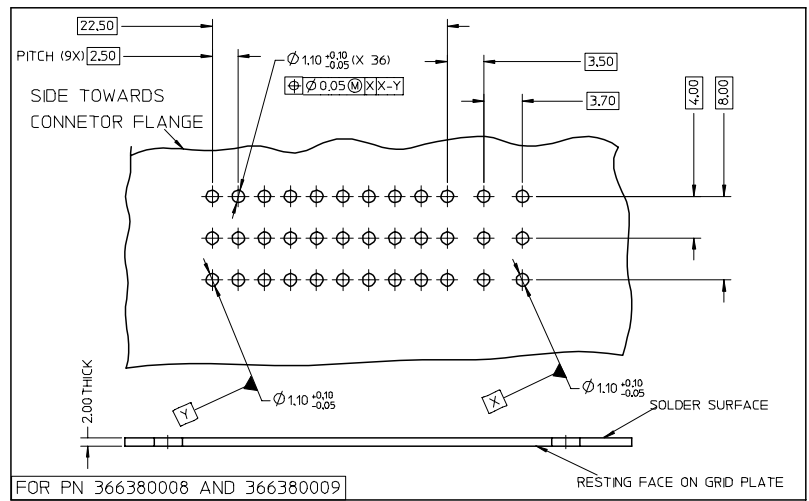
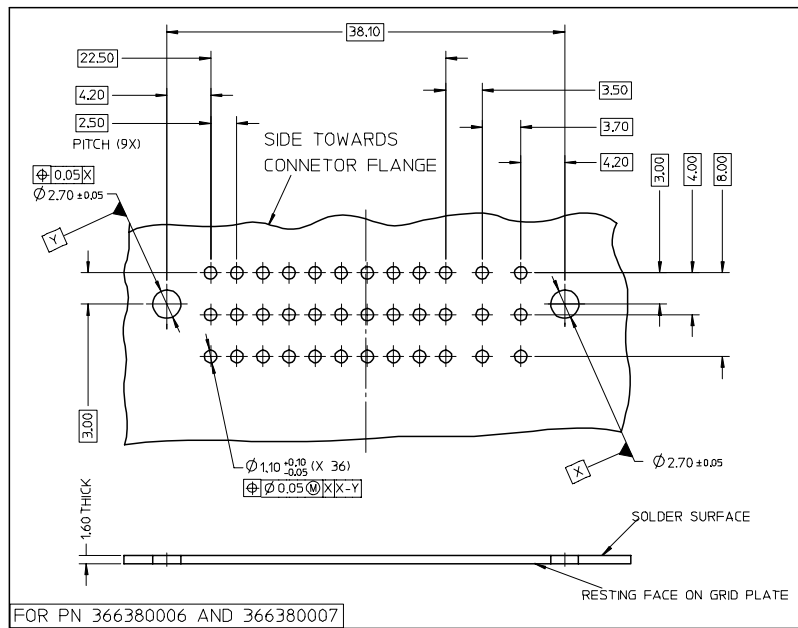
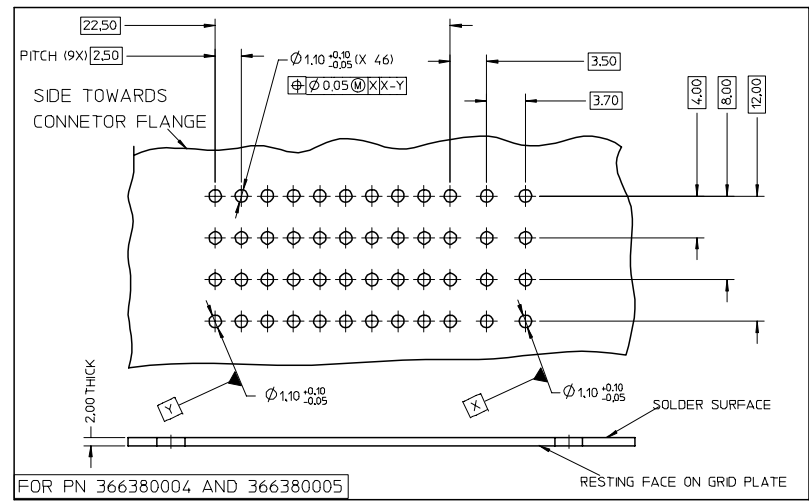
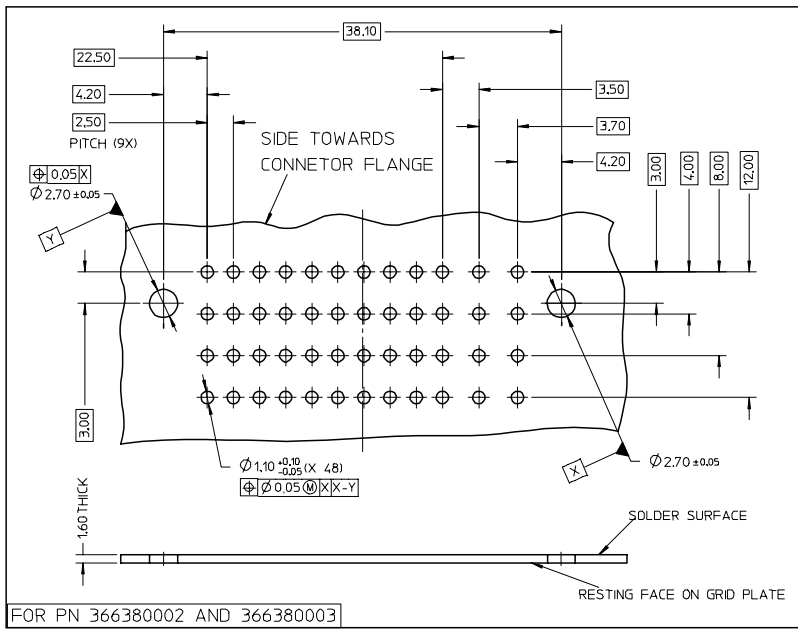

<b>ENTER DESCRIPTION</b> EIC NO.: I2008-0132 DRAWN/RANGAPPAO1 2007/09/20 CHK/KPRASAD 2007/09/21 APPR/KPRASAD 2007/09/21	QUALITY SYMBOLS	GENERAL TOLERANCES (UNLESS SPECIFIED)	DIMENSION STYLE	SCALE	DESIGN UNITS	THIRD ANGLE PROJECTION	
	$\nabla=0$ $\nabla=0$	mm INCH 4 PLACES ± --- ± --- 3 PLACES ± --- ± --- 2 PLACES ± 0.1 ± --- 1 PLACE ± 0.2 ± --- ANGULAR ± 1 °	MM ONLY	1:1	PITCH (9X) METRIC		
	DRAWN BY DATE ROOPESH 08/05/2006 CHECKED BY DATE DINESH 08/05/2006 APPROVED BY DATE DINESH 08/05/2006	DRAFT WHERE APPLICABLE MUST REMAIN WITHIN DIMENSIONS		SEE TABLE 'A' SIZE A2	TITLE CMC HEADER 48/48WAY AND 48/36WAY T3 INTERFACE		
	MATERIAL NO. DOCUMENT NO.	MOLEX INCORPORATED		SHEET NO. 3 OF 3			