

SMFLHP Single and Dual DC/DC Converters

28 VOLT INPUT – 100 WATT

FEATURES

Parallel operation with current share, up to 3 units (228 watts)

- -55° to +125°C operation
- 19 to 40 VDC input
- 50 V for 120 ms transient protection
- Fully isolated, magnetic feedback
- Fixed high frequency switching
- Remote sense or output trim on single output models
- Inhibit function
- Synchronization input and output
- Indefinite short circuit protection
- High power density with up to 87% efficiency



MODELS VDC OUTPUT

SINGLE	DUAL
3.3	±5
5	±12
12	±15
15	

DESCRIPTION

The SMFLHP Series™ 28 volt DC/DC converters are rated up to 100 watts output power over a -55°C to +125°C temperature range with a 28 VDC nominal input. On dual output models, up to 70% of the rated output power can be drawn from either the positive or negative outputs. Current sharing allows the units to be paralleled for total power of up to 228 watts. The welded, hermetically sealed package is only 3.005 x 1.505 x 0.400 inches, giving the series an overall power density of up to 67 watts per cubic inch.

SCREENING

SMFLHP converters offer screening options to Space Prototype (O), Class H, or Class K. Radiation tolerant to Radiation Hardness Assurance (RHA) levels of “-” (O), “P” or “R”, per MIL-STD-38534. Interpoint model numbers use an “O” in the RHA designator position to indicate the “-” (dash) Radiation Hardness Assurance level of MIL-PRF-38534, which is defined as “no RHA”. See “Class H and K, QML Screening” tables for more information.

DESIGN FEATURES

The SMFLHP Series converters are switching regulators that use a quasi-square wave, single ended forward converter design with a constant switching frequency of 600 kHz.

Isolation between input and output circuits is provided with a transformer in the forward path and wide bandwidth magnetic coupling in the feedback control loop. The SMFLHP Series uses a unique dual loop feedback technique that controls output current with an inner feedback loop and output voltage with a cascaded voltage mode feedback loop.

The additional secondary current mode feedback loop improves transient response in a manner similar to primary current mode control and allows for ease of paralleling.

Tight load regulation is achieved through a wide-bandwidth magnetic feedback circuit. The output voltage on single SMFLHP models can be easily trimmed up by adding an external resistor. (See Figure 2 for voltage changes with different resistor values.)

INHIBIT

The SMFLHP Series converters have two inhibit terminals (INH1 and INH2) that can be used to disable power conversion, resulting in a very low quiescent input current. A low (<0.8 volts) is required between INH1 (pin 4) and Input Common (pin 2) to inhibit the converter. A low (<0.5 volts) is required between INH2 (pin 12) and Output Common (pin 8) to inhibit the converter. The application of intermediate voltages to these pins (1.5 to 10.5 volts) should be avoided.

CURRENT SHARING AND PARALLEL OPERATION

Multiple SMFLHP converters may be used in parallel to drive a common load (see Figure 3). In this mode of operation the load current is shared by two or three SMFLHP converters. In current sharing mode, one SMFLHP converter is designated as a master. The SLAVE pin (pin 11) of the master is left unconnected and the MSTR/INH2 pin (pin 12) of the master is connected to the SLAVE pin (pin 11) of the slave units. The units designated as slaves have the MSTR/INH2 pin (pin 12) connected to the SNS RTN pin (pin 9) of the master unit. Figure 3 shows the typical setup for two or three units in parallel. Note that synchronizing the units together (though shown in the figure) is not required for current sharing operation. A second slave unit may be placed in parallel with a master and slave; this requires the TRI pin (pin 3) of the master unit to be connected to the SNS RTN pin (pin 9).

When paralleled, 76% of the total combined power ratings of the SMFLHP converters are available at the load. Overload and short circuit performance are not adversely affected during parallel operation.

SMFLHP Single and Dual DC/DC Converters

28 VOLT INPUT – 100 WATT

OPERATING CONDITIONS AND CHARACTERISTICS

Input Voltage Range

- 19 to 40 VDC continuous
- 50 V for 50 msec transient

Output Power

- up to 100 watts depending on model

Lead Soldering Temperature (10 sec per lead)

- 300°C

Storage Temperature Range (Case)

- -65°C to +150°C

Power Dissipation (Pd)

- 20 watts

Case Operating Temperature (Tc)

- -55 to +125°C full power
- -55 to +135°C absolute

Derating Output Power/Current

- Linearly from 100% at 125°C to 0% at 135°C

Output Voltage Temperature Coefficient

- 100 ppm/°C typical

Input to Output Capacitance

- 150 pF typical

Isolation

- 100 megohm minimum at 500 VDC, any pin to case

Audio Rejection

- 50 dB typical

Conversion Frequency

- Free run mode 600 kHz typical
550 kHz min, 650 kHz. max
- External sync range 525 to 675 kHz

Inhibit Pin Voltage (unit enabled)

- INH1 = 9 to 12 V, INH2 = 6 to 9 V

SYNC IN AND INHIBIT (INH1, INH2)

Sync In (525 to 675 kHz)

- Duty cycle 40% min, 60% max
- Logic low 0.8 V max
- Logic high 4.5 V min, 5 V max
- Referenced to input common
- If not used, connect to input common

Sync Out

- Referenced to input common

Inhibit (INH1, INH2) Open Collector

- Logic low (output disabled)
Current -10 to -5 mA
INH1 referenced to input common
Logic low 0.8 V max
INH2 referenced to output common
Logic low 0.5 V max
- Logic high (output enabled)
Open collector

MECHANICAL AND ENVIRONMENTAL

Size (maximum)

3.005 x 1.505 x 0.400 inches (76.33 x 38.23 x 10.16 mm)
See case U for dimensions.

Weight (maximum)

86 grams

Screening

Space Prototype (O), Class H, or Class K Radiation tolerant to Radiation Hardness Assurance (RHA) levels of “-” (O), “P” or “R”, per MIL-STD-38534. Interpoint model numbers use an “O” in the RHA designator position to indicate the “-” (dash) Radiation Hardness Assurance level of MIL-PRF-38534, which is defined as “no RHA”.

See “Class H and K, QML Screening” tables for more information.
Available configurations: OO, HO, HP, HR, KR

SMFLHP Single and Dual DC/DC Converters

28 VOLT INPUT – 100 WATT

PIN OUT

PINS NOT IN USE

Pin	Single Output	Dual Output		
1	Positive Input	Positive Input	TR1	Leave unconnected
2	Input Common	Input Common	Inhibit (INH1)	Leave unconnected
3	Triple (TRI)	Triple (TRI)	Sync Out	Leave unconnected
4	Inhibit 1 (INH1)	Inhibit 1 (INH1)	Sync In	Connect to input common
5	Sync Out	Sync Out	Sense Lines	Must be connected to appropriate outputs
6	Sync In	Sync In	Slave	Leave unconnected
7	Positive Output	Positive Output	MSTR (INH 2)	Leave unconnected
8	Output Common	Output Common		
9	Sense Return	Negative Output		
10	Positive Sense	No connection		
11	Slave	Slave		
12	Master / Inhibit 2 (MSTR/INH2)	Master / Inhibit 2 (MSTR/INH2)		

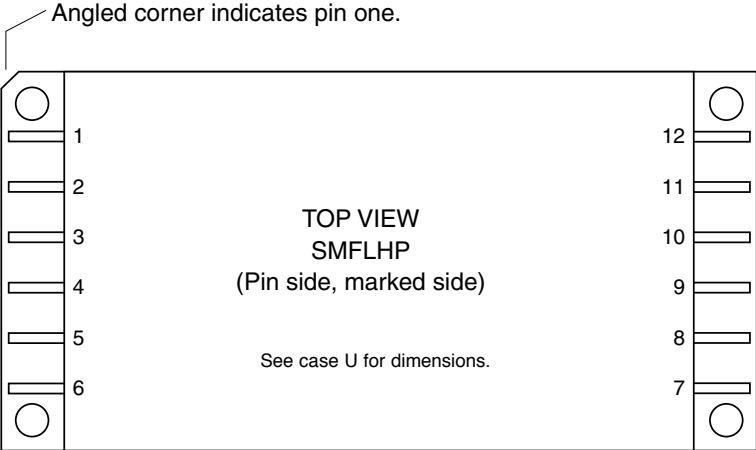
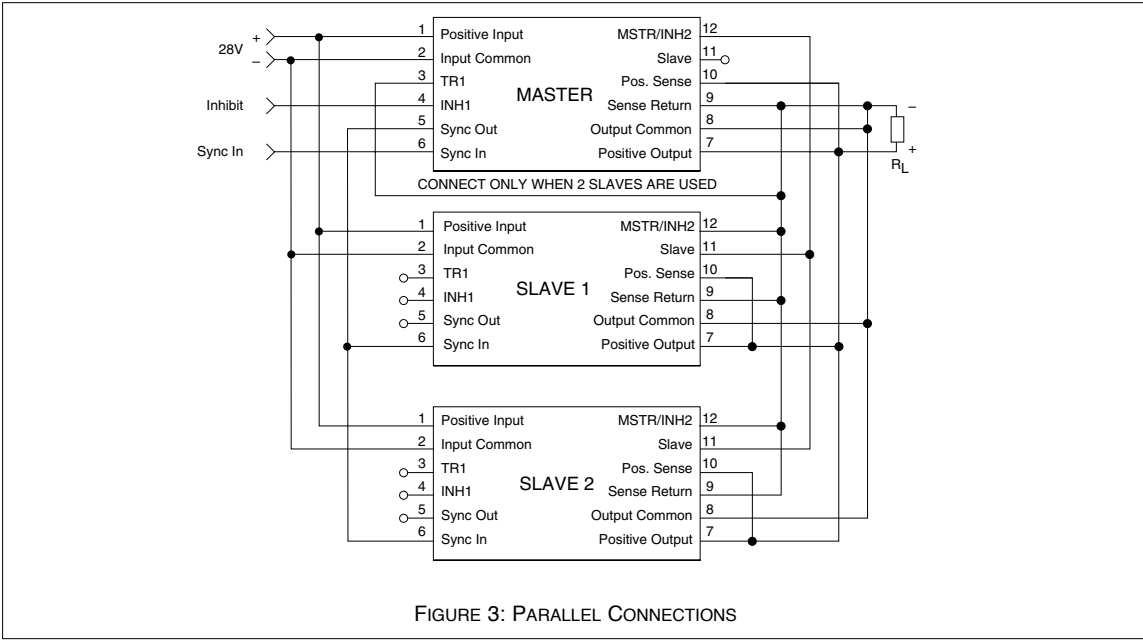
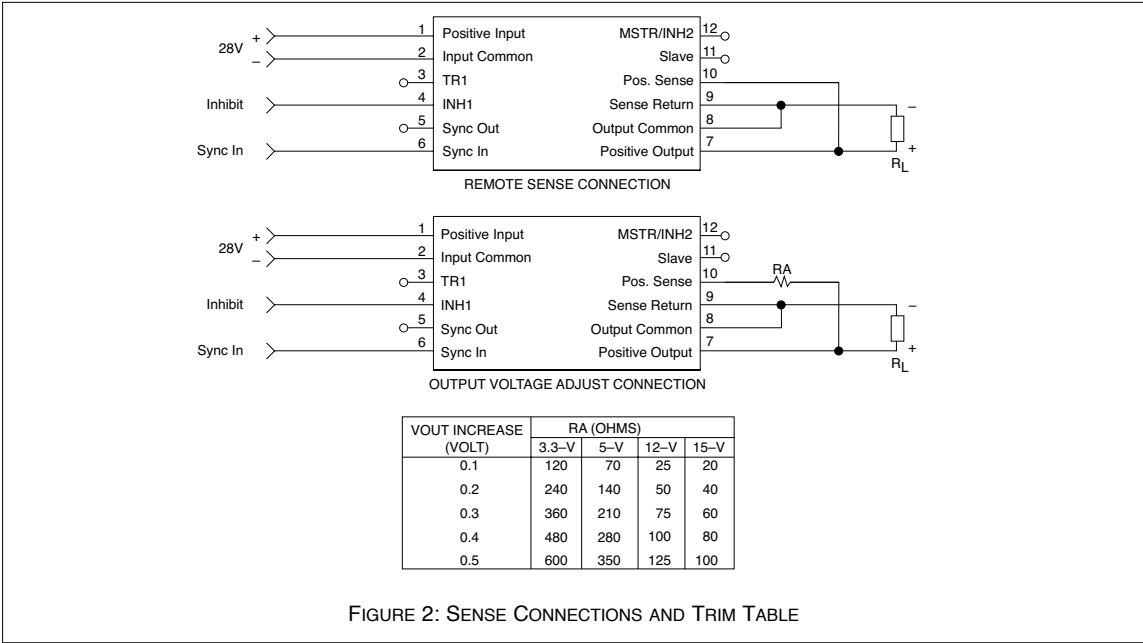

FIGURE 1: PIN OUT

SMFLHP Single and Dual DC/DC Converters

28 VOLT INPUT – 100 WATT

SINGLE OUTPUT MODELS CONNECTION DIAGRAMS - SENSE AND PARALLEL



SMFLHP Single and Dual DC/DC Converters

28 VOLT INPUT – 100 WATT

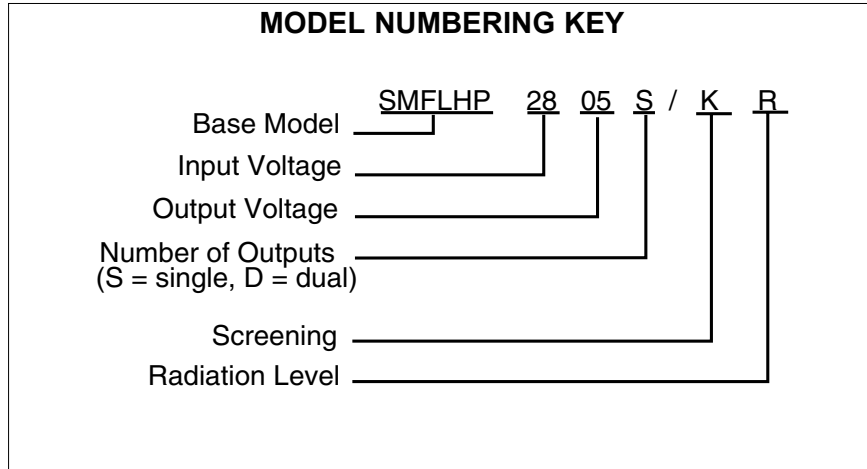

MODEL SELECTION

SMFLHP28 _____ _____ / _____
 base model V_{out} value number of outputs screening

Choose one from each of the following rows:

V_{out} value	for singles 3R3, 5, 12, 15 for duals: 5, 12, 15 "R" = decimal point, 3R3 = 3.3VDC
Number of outputs	S (single) or D (dual)
Case option	standard (case U, leave blank)
Screening	OO* - Space prototype, HO, HP, HR, KR

*Interpoint model numbers use an "O" in the RHA designator position to indicate the "-" (dash) Radiation Hardness Assurance level of MIL-PRF-38534, which is defined as "no RHA"

SMFLHP Single and Dual DC/DC Converters

28 VOLT INPUT – 100 WATT

Electrical Characteristics: –55°C to +125°C Tc, 28 VDC Vin, 100% load, free run, unless otherwise specified.

SINGLE OUTPUT MODELS		SMFLHP283R3S			SMFLHP2805S			SMFLHP2812S			SMFLHP2815S			UNITS
PARAMETER	CONDITIONS	MIN	TYP	MAX	MIN	TYP	MAX	MIN	TYP	MAX	MIN	TYP	MAX	
OUTPUT VOLTAGE	TC = 25°C	3.26	3.30	3.34	4.95	5.00	5.05	11.88	12.00	12.12	14.85	15.00	15.15	VDC
OUTPUT CURRENT	VIN = 19 TO 40 VDC	0	–	16	0	–	16	0	–	7.5	0	–	6.67	A
OUTPUT POWER	VIN = 19 TO 40 VDC	0	–	53	0	–	80	0	–	90	0	–	100	W
OUTPUT RIPPLE 10 KHZ - 2 MHZ	TC = 25°C	–	10	25	–	15	50	–	30	85	–	30	95	mV p-p
	TC = -55°C TO +125°C	–	20	40	–	30	90	–	45	150	–	45	175	
LINE REGULATION	VIN = 19 TO 40 VDC	–	0	50	–	0	50	–	0	50	–	0	50	mV
LOAD REGULATION	NO LOAD TO FULL	–	0	20	–	0	20	–	0	20	–	0	20	mV
INPUT VOLTAGE NO LOAD TO FULL	CONTINUOUS	19	28	40	19	28	40	19	28	40	19	28	40	VDC
	TRANSIENT ^{1, 2} 50 ms	–	–	50	–	–	50	–	–	50	–	–	50	V
INPUT CURRENT	NO LOAD	–	70	120	–	70	120	–	80	120	–	80	120	mA
	INHIBITED - INH1	–	9	15	–	9	15	–	9	15	–	9	15	
	INHIBITED - INH2	–	35	80	–	35	80	–	35	80	–	35	80	
INPUT RIPPLE CURRENT	10 KHZ - 10 MHZ	–	30	80	–	30	80	–	30	80	–	30	80	mA p-p
EFFICIENCY	TC = 25°C	70	72	–	77	80	–	81	86	–	82	87	–	%
LOAD FAULT TC = 25°C	SHORT CIRCUIT POWER DISSIPATION	–	15	22	–	15	20	–	15	20	–	15	20	W
	RECOVERY ¹	–	1.5	10	–	1.5	4	–	1.5	4	–	1.5	4	ms
STEP LOAD RESPONSE	50% - 100% - 50% TRANSIENT	–	350	400	–	350	450	–	450	700	–	450	700	mV pk
	RECOVERY ^{1, 3}	–	1.5	3.0	–	1.5	3.0	–	1.5	3.0	–	1.5	3.0	ms
STEP LINE RESPONSE ¹	19 - 40 - 19 VDC TRANSIENT ⁴	–	250	400	–	250	400	–	250	800	–	250	800	mV pk
	RECOVERY ³	–	200	300	–	200	600	–	200	600	–	200	600	μs
START-UP	DELAY	–	3.5	10	–	3.5	10	–	3.5	10	–	3.5	10	ms
	OVERSHOOT ¹	–	0	50	–	0	25	–	0	50	–	0	50	mV pk

Notes

1. Guaranteed by design, not tested.

2. Unit will shut down above approximately 45V but will be undamaged and will restart when voltage drops into normal range.

3. Recovery time is measured from application of the transient to point at which Vout is within 1% of final value.

4. Transition time >10 μs.

SMFLHP Single and Dual DC/DC Converters

28 VOLT INPUT – 100 WATT

Electrical Characteristics: –55°C to +125°C Tc, 28 VDC Vin, 100% load, free run, unless otherwise specified.

DUAL OUTPUT MODELS		SMFLHP2805D			SMFLHP2812D			SMFLHP2815D			UNITS	
PARAMETER	CONDITIONS	MIN	TYP	MAX	MIN	TYP	MAX	MIN	TYP	MAX		
OUTPUT VOLTAGE TC = 25°C	+ V _{OUT}	4.95	5.00	5.05	11.88	12.00	12.12	14.85	15.00	15.15	VDC	
	- V _{OUT}	4.92	5.00	5.08	11.80	12.00	12.18	14.77	15.00	15.23		
OUTPUT CURRENT ² VIN = 19 TO 40 VDC	EACH OUTPUT	0	–	11.2	0	–	5.3	0	–	4.67	A	
	TOTAL	0	–	16.0	0	–	7.5	0	–	6.67		
OUTPUT POWER ² VIN = 19 TO 40 VDC	EACH OUTPUT	0	–	56	0	–	63	0	–	70	W	
	TOTAL	0	–	80	0	–	90	0	–	100		
OUTPUT RIPPLE	10 kHz - 2 MHz	+ V _{OUT}	–	25	150	–	50	175	–	50	225	mV p-p
		- V _{OUT}	–	25	150	–	50	175	–	50	225	
LINE REGULATION VIN = 19 TO 40 VDC	+ V _{OUT}	–	0	50	–	0	50	–	0	50	mV	
	- V _{OUT}	–	25	100	–	25	100	–	25	100		
LOAD REGULATION NO LOAD TO FULL	+ V _{OUT}	–	0	50	–	10	100	–	10	100	mV	
	- V _{OUT}	–	25	100	–	50	200	–	50	200		
CROSS REGULATION TC = 25°C	SEE NOTE 3	–	6	8	–	2	4	–	2	4	%	
	SEE NOTE 4	–	7	8	–	2	4	–	2	4		
INPUT VOLTAGE NO LOAD TO FULL	CONTINUOUS	19	28	40	19	28	40	19	28	40	VDC	
	TRANSIENT ^{1, 5} 50 ms	0	–	50	0	–	50	0	–	50	V	
INPUT CURRENT TC = 25°C	NO LOAD	–	50	120	–	50	120	–	50	120	mA	
	INHIBITED - INH1	–	9	14	–	9	14	–	9	14		
	INHIBITED - INH2	–	35	80	–	35	80	–	35	80		
INPUT RIPPLE CURRENT	10 kHz - 10 MHz	–	30	80	–	30	80	–	30	80	mA p-p	
EFFICIENCY TC = 25°C	BALANCED LOAD	75	80	–	81	86	–	82	87	–	%	
LOAD FAULT TC = 25°C	POWER DISSIPATION SHORT CIRCUIT	–	15	20	–	15	20	–	15	20	W	
	RECOVERY ^{1, 6}	–	1.5	4.0	–	1.5	4.0	–	1.5	4.0	ms	
STEP LOAD RESPONSE ± V _{OUT}	50% - 100% - 50% TRANSIENT	–	350	450	–	450	700	–	450	700	mV pk	
	RECOVERY ^{1, 6}	–	1.5	3.0	–	1.5	3.0	–	1.5	3.0	ms	
STEP LINE RESPONSE ¹ ± V _{OUT}	19 - 40 -19 VDC TRANSIENT ^{1, 7}	–	250	600	–	250	800	–	250	800	mV pk	
	RECOVERY ^{1, 6}	–	200	300	–	200	600	–	200	600	μs	
START-UP	DELAY	–	3.5	20	–	3.5	20	–	3.5	20	ms	
	OVERSHOOT ¹	–	0	25	–	0	50	–	0	50	mV pk	

Notes

1. Guaranteed by design, not tested.
2. Up to 70% of the total output power (current) is available from either output provided the opposite output is carrying 30% of the power (current) in use.
3. Effect on negative V_{out} from 50%/50% loads to 30%/70% or 70%/30% loads.
4. Effect on negative V_{out} from 50%/50% loads to 10% then 50% load on negative V_{out}
5. Unit will shut down above approximately 45V but will be undamaged and will restart when voltage drops into normal range.
6. Recovery time is measured from application of the transient to point at which V_{out} is within 1% of final value.
7. Transition time >10 μs.

SMFLHP Single and Dual DC/DC Converters

28 VOLT INPUT – 100 WATT

Typical Performance Curves: 25°C Tc , 28 VDC Vin, 100% load, free run, unless otherwise specified.

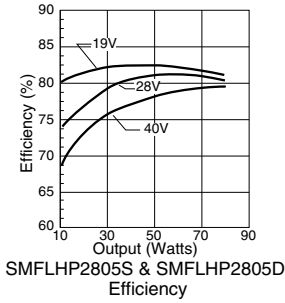

FIGURE 4

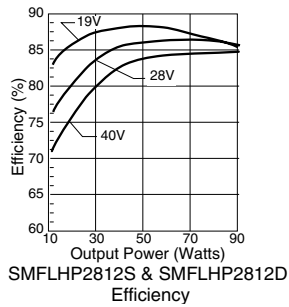

FIGURE 5

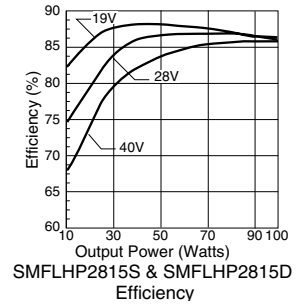

FIGURE 6

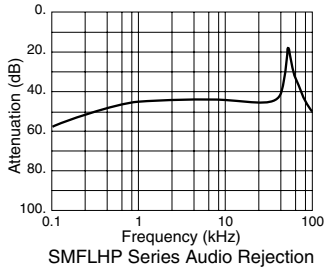

FIGURE 7

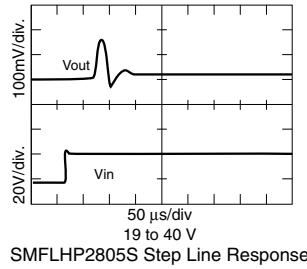

FIGURE 8

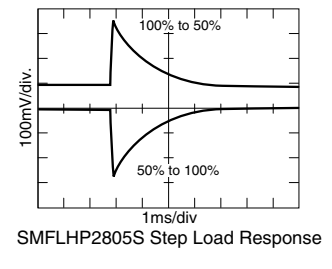

FIGURE 9

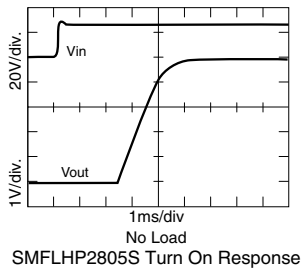

FIGURE 10

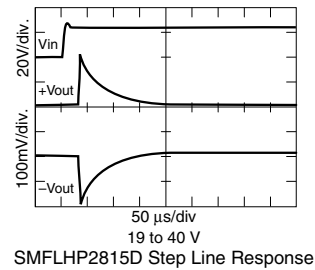

FIGURE 11

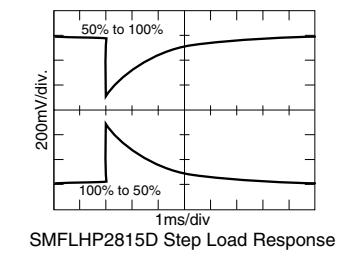

FIGURE 12

SMFLHP Single and Dual DC/DC Converters

28 VOLT INPUT – 100 WATT

Typical Performance Curves: 25°C Tc , 28 VDC Vin, 100% load, free run, unless otherwise specified.

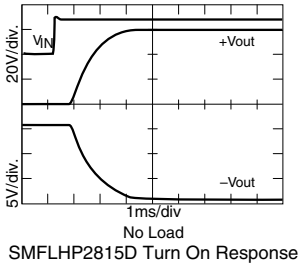

FIGURE 13

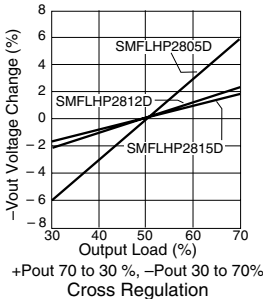

FIGURE 14

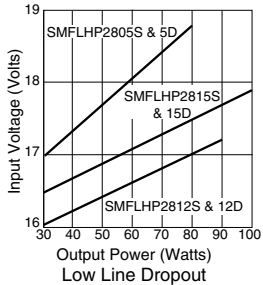
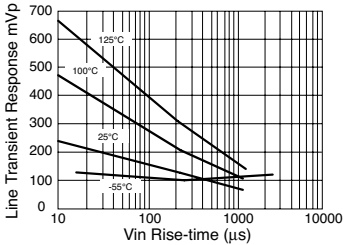

FIGURE 15



SMFLHP2815D Line Transient Response vs. Vin Rise-time

FIGURE 16

SMFLHP Single and Dual DC/DC Converter Cases

28 VOLT INPUT – 100 WATT

TOP VIEW CASE U Flanged case, short-leaded

*Case U does not require designator in Case Option position of model number.

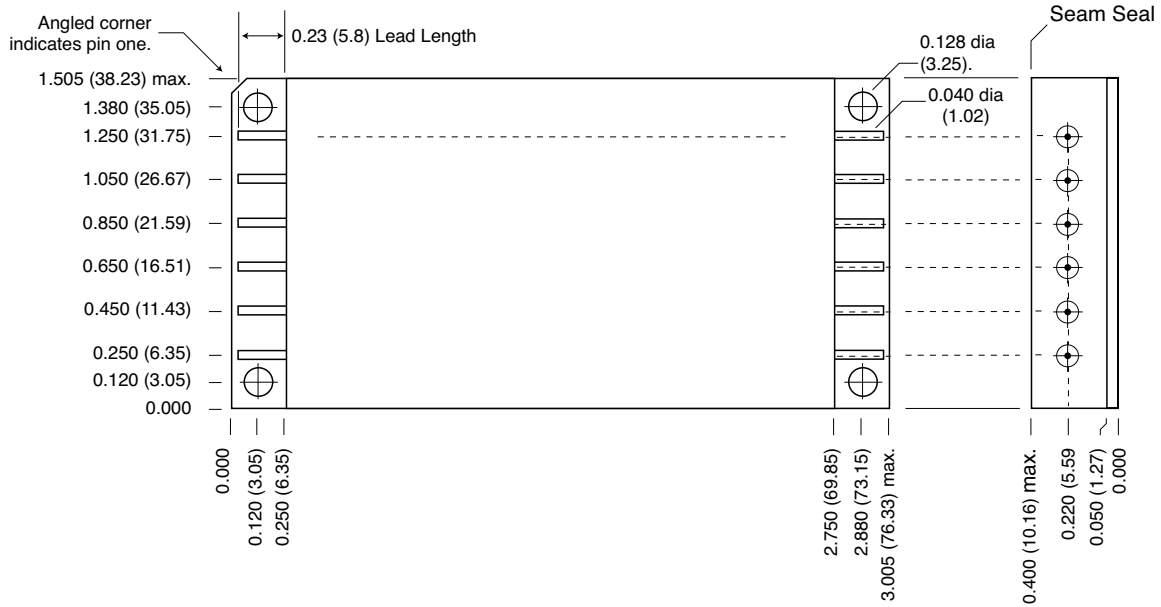

Case dimensions in inches (mm)

Tolerance ± 0.005 (0.13) for three decimal places
 ± 0.01 (0.3) for two decimal places
 unless otherwise specified

CAUTION

Heat from reflow or wave soldering may damage the device.
 Solder pins individually with heat application not exceeding 300°C for 10 seconds per pin

Materials

Header Cold Rolled Steel/Nickel/Gold
 Cover Kovar/Nickel
 Pins #52 alloy/Nickel/Gold; compression glass seal

Case U, Rev C, 20060302

Please refer to the numerical dimensions for accuracy. All information is believed to be accurate, but no responsibility is assumed for errors or omissions. Interpoint reserves the right to make changes in products or specifications without notice.
 Copyright © 1999-2006 Interpoint Corp. All rights reserved.

FIGURE 16: CASE U

SMFLHP Single and Dual DC/DC Converters

28 VOLT INPUT – 100 WATT

CLASS H AND K, MIL-PRF-38534 ELEMENT EVALUATION

COMPONENT-LEVEL TEST PERFORMED	SPACE PROTOTYPE (O) NON-QML ¹		CLASS H QML		CLASS K QML	
	M/S ²	P ³	M/S ²	P ³	M/S ²	P ³
Element Electrical	yes	no	yes	yes	yes	yes
Element Visual	no	no	yes	yes	yes	yes
Internal Visual	no	N/A	yes	N/A	yes	N/A
Temperature Cycling	no	no	no	no	yes	yes
Constant Acceleration	no	no	no	no	yes	yes
Interim Electrical	no	N/A	no	N/A	yes	N/A
Burn-in	no	N/A	no	N/A	yes	N/A
Post Burn-in Electrical	no	N/A	no	N/A	yes	N/A
Steady State Life	no	N/A	no	N/A	yes	N/A
Voltage Conditioning Aging	N/A	no	N/A	no	N/A	yes
Visual Inspection	no	no	N/A	no	N/A	yes
Final Electrical	no	no	yes	yes	yes	yes
Wire Bond Evaluation ⁴	no	no	yes	yes	yes	yes
SEM	no	N/A	no	N/A	yes	N/A
SLAM™/C-SAM: Input capacitors only (Add'l test, not req. by H or K)	no	no	no	yes	no	yes

Notes:

1. Non-QML products do not meet all of the requirements of MIL-PRF-38534.
2. M/S = Active components (Microcircuit and Semiconductor Die)
3. P = Passive components
4. Not applicable to EMI filters that have no wirebonds.

Definitions:

Element Evaluation: Component testing/screening per MIL-STD-883 as determined by MIL-PRF-38534

SEM: Scanning Electron Microscopy

SLAM™: Scanning Laser Acoustic Microscopy

C-SAM: C - Mode Scanning Acoustic Microscopy

SMFLHP Single and Dual DC/DC Converters

28 VOLT INPUT – 100 WATT

CLASS H AND K, MIL-PRF-38534 ENVIRONMENTAL SCREENING

END ITEM-LEVEL TEST PERFORMED	SPACE PROTOTYPE (O) NON-QML ¹	CLASS H QML	CLASS K QML
Non-destruct bond pull Method 2023	no	yes ²	yes
Pre-cap Inspection Method 2017, 2032	yes	yes	yes
Temperature Cycle (10 times) Method 1010, Cond. C, -65°C to 150°C, ambient	yes	yes	yes
Constant Acceleration Method 2001, 3000 g	yes	yes	yes
PIND Test Method 2020, Cond. A	no	yes ²	yes
Pre burn-in test	yes	yes	yes
Burn-in Method 1015, 125°C case, typical			
96 hours	yes	no	no
160 hours	no	yes	no
2 x 160 hours (includes mid-BI test)	no	no	yes
Final Electrical Test MIL-PRF-38534 Group A, Subgroups 1 through 6 -55°C, +25°C, +125°C case	yes	yes	yes
Radiography Method 2012	N/A	N/A	N/A
Post Radiography Electrical Test Room temperature	N/A	N/A	yes ²
Hermeticity Test Fine Leak, Method 1014, Cond. A Gross Leak, Method 1014, Cond. C	yes yes	yes yes	yes yes
Final visual inspection Method 2009	yes	yes	yes

Test methods are referenced to MIL-STD-883 as determined by MIL-PRF-38534.

Notes:

1. Space Prototype (O), non-QML products, do not meet all of the requirements of MIL-PRF-38534.
2. Not required by DSCC but performed to assure product quality.

SMFLHP Single and Dual DC/DC Converters

28 VOLT INPUT – 100 WATT

CLASS H AND K, MIL-PRF-38534 RADIATION ASSURANCE

RADIATION HARDNESS ASSURANCE LEVELS	ENVIRONMENTAL SCREENING LEVELS		
	SPACE PROTOTYPE (O) NON-QML ²	CLASS H QML	CLASS K QML
O ¹ : Standard, no radiation guarantee	OO	HO	N/A
P : Radiation tolerant—Tested lots up to 30 K Rads (Si) total dose SEU guarantee up to 40 MeV	N/A	HP ³	N/A
R : Radiation tolerant—Tested lots up to 100 K Rads (Si) total dose SEU guarantee up to 40 MeV	N/A	HR ³	KR ³

Notes:

- Interpoint model numbers use an "O" in the RHA designator position to indicate the "-" (dash) Radiation Hardness Assurance level of MIL-PRF-38534, which is defined as "no RHA".
- Space Prototype (O), non-QML, products do not meet all of the requirements of MIL-PRF-38534.
- Redmond site, Interpoint, has a Radiation Hardness assurance plan on file with DSCC. Our SMD products with RHA "P" and "R" code meet DSCC requirements.