

PLEASE CHECK WWW.MOLEX.COM FOR LATEST PART INFORMATION

Part Number: [0480372001](#)
Status: **Active**
Description: Universal Serial Bus (USB) Shielded I/O Plug, Type A, Right Angle, Surface Mount, 0.76µm (30µ") Gold (Au) Plating, PCB Thickness 1.60mm (.063"), Tape on Reel Package, Lead Free

Documents:

[3D Model](#) [Product Specification PS-48037-001 \(PDF\)](#)
[Drawing \(PDF\)](#) [RoHS Certificate of Compliance \(PDF\)](#)

General

Product Family	I/O Connectors
Series	48037
Application	Wire-to-Board
Component Type	Plug
Product Name	USB
Type	A

Physical

Boot Color	N/A
Circuits (Loaded)	4
Circuits (maximum)	4
Gender	Plug
Keying to Mating Part	Yes
Lock to Mating Part	Yes
Material - Plating Mating	Gold
Material - Plating Termination	Tin
Number of Rows	1
Orientation	Right Angle
PCB Locator	Yes
PCB Retention	Yes
Packaging Type	Embossed Tape on Reel
Panel Mount	Yes
Pitch - Mating Interface (in)	0.078 In, 0.098 In
Pitch - Mating Interface (mm)	2.00 mm, 2.50 mm
Pitch - Term. Interface (in)	0.078 In, 0.098 In
Pitch - Term. Interface (mm)	2.00 mm, 2.50 mm
Plating min: Mating (µin)	30
Plating min: Mating (µm)	0.76
Plating min: Termination (µin)	122
Plating min: Termination (µm)	3.05
Polarized to Mating Part	Yes
Polarized to PCB	Yes
Ports	1
Surface Mount Compatible (SMC)	Yes
Temperature Range - Operating	-20°C to +85°C
Termination Interface: Style	Surface Mount
Waterproof / Dustproof	No

Electrical

Current - Maximum	1.5A
Shield Type	Full Shield
Shielded	Yes
Voltage - Maximum	150V AC (RMS)

Material Info

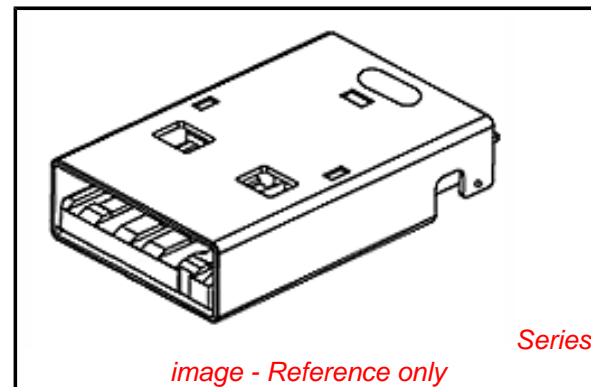

image - Reference only

EU RoHS

**ELV and RoHS
Compliant**
REACH SVHC
 Not Reviewed
**Halogen-Free
Status**

China RoHS



Not Reviewed

**Need more information on product
environmental compliance?**

Email productcompliance@molex.com
 For a multiple part number RoHS Certificate of Compliance, [click here](#)

Please visit the [Contact Us](#) section for any non-product compliance questions.

Search Parts in this Series

[48037Series](#)

Mates With

USB Type A Receptacle

Reference - Drawing Numbers

Product Specification
Sales Drawing

PS-48037-001
SD-48037-005

This document was generated on 02/05/2010

PLEASE CHECK WWW.MOLEX.COM FOR LATEST PART INFORMATION

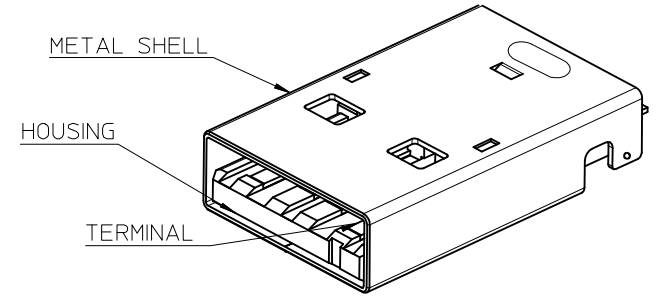
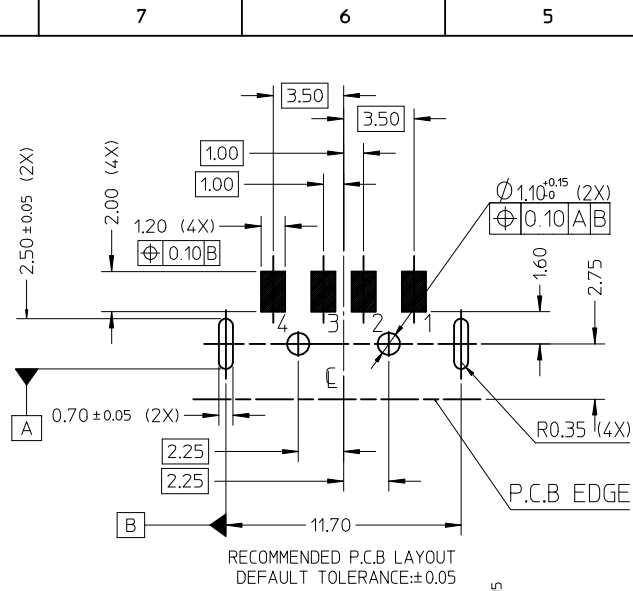
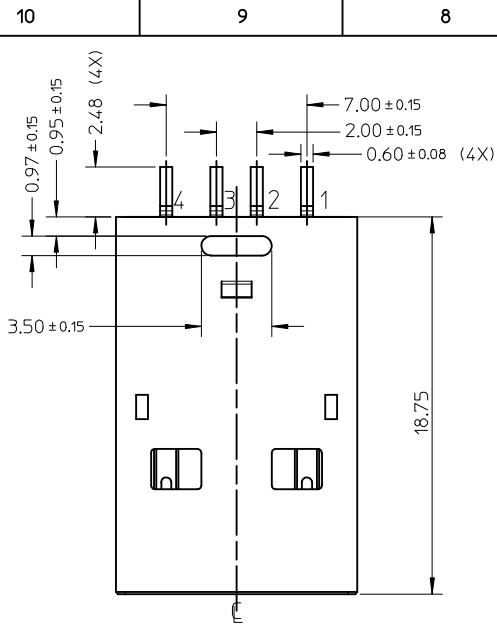

- NOTES:
- MATERIAL:
 - HOUSING: PA46, GLASS FIBER FILLED, UL94V-0, COLOR: BLACK.
 - TERMINAL: BRASS
 - METAL SHELL: COLD ROLL STEEL
 - FINISH:
 - TERMINAL:
 - GOLD(Au) IN CONTACT AREA
 - THICKNESS=30 MICROINCH MINIMUM.
 - TIN(Sn) ALLOY IN SOLDER TAIL AREA
 - THICKNESS=120 MICROINCH MINIMUM.
 - NICKEL(Ni) OVERALL
 - THICKNESS=50 MICROINCH MINIMUM.
 - METAL SHELL:
 - NICKEL(Ni) OVERALL
 - THICKNESS=50 MICROINCH MINIMUM.
 - UNDER PLATED: COPPER(Cu), OVERALL
 - THICKNESS=50 MICROINCH MINIMUM.
 - RECOMMENDED PCB THICKNESS: 1.0mm ± 0.05
 - PRODUCT SPECIFICATION REFERS TO PS-48037-001
 - PACKAGE SPECIFICATION REFERS TO PK-48037-210
 - TEST SUMMARY REFERS TO TS-48037-001
 - COPLANARITY TO BE 0.1mm MAX.
 - LEAD FREE AND RoHS COMPLIANCE.
 - DATE CODE:

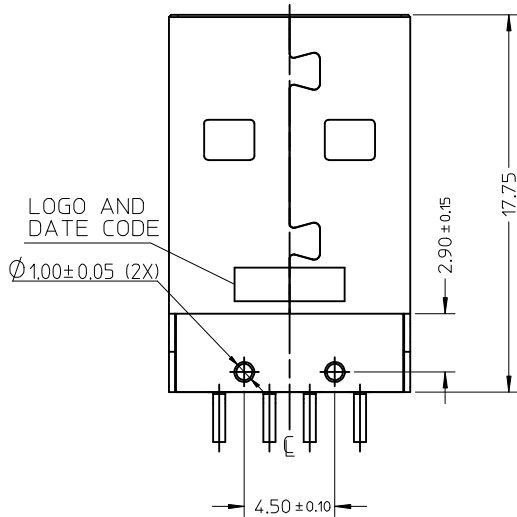
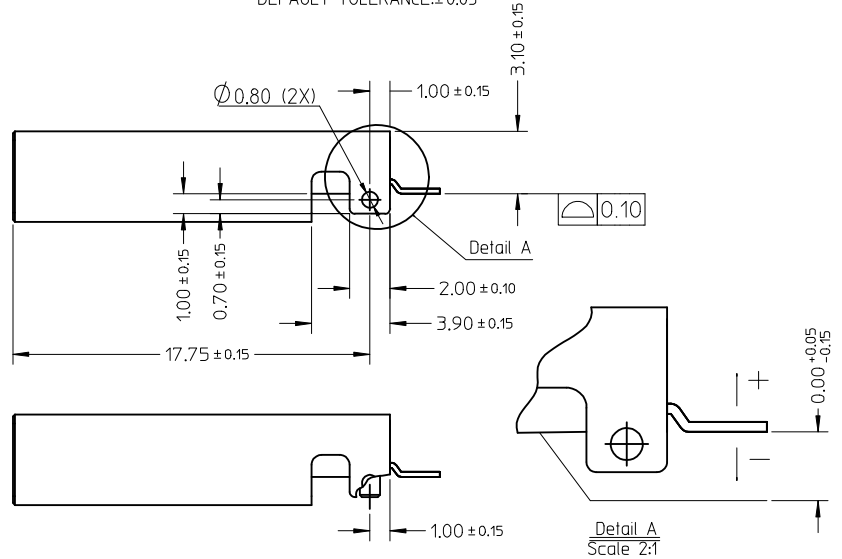
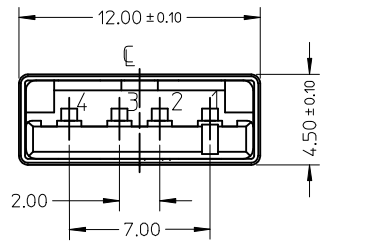
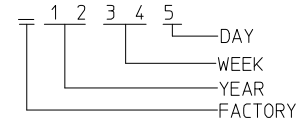

CHANGE TOLERANCE EC NO: SH2009-0030 DRWN: GWANG08 2008/08/14 CHYK: DMZHANG02 2008/08/15 APPR: HWANG 2008/10/20	QUALITY SYMBOLS 	GENERAL TOLERANCES (UNLESS SPECIFIED)		DIMENSION STYLE MM ONLY	SCALE 1:1	DESIGN UNITS METRIC	THIRD ANGLE PROJECTION	
		4 PLACES ± --- ± ---	DRAWN BY JASON	DATE 05/21/2007	TITLE USB A TYPE PLUG R/A SMT CONNECTOR			
		3 PLACES ± --- ± ---	CHECKED BY BKANG	DATE 05/21/2007	MATERIAL NO. 48037-2001			
		2 PLACES ± 0.20 ± --- 1 PLACE ± 0.25 ± ---	APPROVED BY ALL IN	DATE 05/21/2007	DOCUMENT NO. SD-48037-005			
REV B	DESCRIPTION DRAFT WHERE APPLICABLE MUST REMAIN WITHIN DIMENSIONS	SIZE A3	THIS DRAWING CONTAINS INFORMATION THAT IS PROPRIETARY TO MOLEX INCORPORATED AND SHOULD NOT BE USED WITHOUT WRITTEN PERMISSION					