

# NON-ISOLATED DC/DC CONVERTERS

4.5 Vdc - 14 Vdc Input, 0.59 Vdc - 5.5 Vdc /6 A Outputs



October 8, 2009

Bel Power, Inc., a subsidiary of Bel Fuse, Inc.

SLIN-06E2Ax

RoHS Compliant

Rev.D

## Features

- Wide Input Voltage Range
- Fixed Switching Frequency
- Power Good Signal
- Remote Sense
- Remote On/Off
- Tunable Loop™ (a registered trademark of Lineage Power Systems) to Optimize Dynamic output voltage response
- Class 1, Category 2, Non-Isolated DC/DC Converter (refer to IPC-9592)
- Compliant to RoHS EU Directive 2002/95/EC
- Compatible in a Pb-free or SnPb reflow environment
- UL\* 60950-1 Recognized, CSA† C22.2 No. 60950-1-03 Certified
- VDE‡ 0805:2001-12 (EN60950-1) Licensed
- Ability to Sink and Source Current
- Cost Efficient Open Frame Design
- Over Temperature Protection
- Output Over Current Protection

## Applications

- Distributed power architectures
- Intermediate bus voltage applications
- Telecommunications equipment
- Servers and storage applications
- Networking equipment
- Industrial equipment



## Description

The SLIN-06E2Ax power modules are non-isolated dc/dc converters that can deliver up to 6A of output current. These modules operate over a wide range of input voltage ( $V_{IN} = 4.5Vdc-14Vdc$ ) and provide a precisely regulated output voltage from 0.59Vdc to 5.5Vdc, programmable via an external resistor. Features include remote On/Off, adjustable output voltage, and over current and over temperature protection. A new feature, the Tunable Loop™, allows the user to optimize the dynamic response of the converter to match the load with reduced amount of output capacitance leading to savings on cost and PWB area.

## Part Selection

Output Voltage	Input Voltage	Max. Output Current	Typical Efficiency	Model Number Active High	Model Number Active Low
0.59 Vdc - 5.5 Vdc	4.5 Vdc - 14 Vdc	6 A	91%	SLIN-06E2A0	SLIN-06E2AL

**Notes:** Add "G" suffix at the end of the model number to indicate Tray Packaging.

# NON-ISOLATED DC/DC CONVERTERS

4.5 Vdc - 14 Vdc Input, 0.59 Vdc - 5.5 Vdc /6 A Outputs



October 8, 2009

Bel Power, Inc., a subsidiary of Bel Fuse, Inc.

## Part Number Explanation

S LIN - 06 E 2A 0  
 1 2 3 4 5 6

1---Surface mount  
 2---Series code  
 3---Output current (6A)

4---Wide input voltage range (4.5-14V)  
 5---Wide output voltage range (0.59-5.5V)  
 6---Enable, active high, change "0" to "L"  
 means active low

## Absolute Maximum Ratings

Parameter	Min	Typ	Max	Unit	Notes
Continuous Input Voltage	-0.3	-	15	V	
Operating Ambient Temperature	-40	-	85	°C	
Storage Temperature	-55	-	125	°C	

**Note:** Stresses in excess of the absolute maximum ratings can cause permanent damage to the device. These are absolute stress ratings only, functional operation of the device is not implied at these or any other conditions in excess of those given in the operations sections of the data sheet. Exposure to absolute maximum ratings for extended periods can adversely affect the device reliability.

## Input Specifications

Parameter	Min	Typ	Max	Unit	Notes
Operating Input Voltage	4.5	-	14	V	
Input Current (full load)	-	-	6.5	A	V <sub>IN</sub> =4.5V to 14V
Input Current (no load)					
V <sub>o</sub> =0.6V	-	16	-	mA	V <sub>IN</sub> =12V, module enabled
V <sub>o</sub> =3.3V	-	55	-	mA	
Input Stand-by Current	-	1.2	-	mA	V <sub>IN</sub> = 12.0Vdc, module disabled
Input Reflected Ripple Current (pk-pk)	-	86	-	mA	5Hz to 20MHz, 1µH source impedance; V <sub>IN</sub> =0 to 14V, I <sub>o</sub> = I <sub>Omax</sub> ; See Test Configurations
I <sup>2</sup> t Inrush Current Transient	-	-	1	A <sup>2</sup> s	
Input Ripple Rejection (120Hz)	-	50	-	dB	
Turn-on Threshold	-	-	4.0	V	
Turn-off Threshold	3.6	-	-	V	
Hysteresis	0.4	-	-	V	

**CAUTION: This converter is not internally fused. An input line fuse must be used in application.**

This power module can be used in a wide variety of applications, ranging from simple standalone operation to an integrated part of sophisticated power architecture. To preserve maximum flexibility, internal fusing is not included; however, to achieve maximum safety and system protection, always use an input line fuse. The safety agencies require a fast-acting fuse with a maximum rating of 6A. Based on the information provided in this data sheet on inrush energy and maximum dc input current, the same type of fuse with a lower rating can be used. Refer to the fuse manufacturer's data sheet for further information.

**Note:** Unless otherwise indicated, specifications apply over all operating input voltage, resistive load, and temperature conditions.

# NON-ISOLATED DC/DC CONVERTERS

4.5 Vdc - 14 Vdc Input, 0.59 Vdc - 5.5 Vdc / 6 A Outputs



October 8, 2009

Bel Power, Inc., a subsidiary of Bel Fuse, Inc.

## Output Specifications

Parameter	Min	Typ	Max	Unit	Notes
Output Voltage Set Point	-1.5	-	+1.5	%Vo,set	with 0.5% tolerance for external resistor used to set output voltage
Output Voltage	-2.5	-	+2.5	%Vo,set	Over all operating input voltage, resistive load, and temperature conditions until end of life
Adjustment Range <sup>1</sup>	0.59	-	5.5	V	selected by an external resistor
Remote Sense Range	-	-	0.5	V	
Load Regulation					
$V_o \geq 2.5V$	-	-	10	mV	$I_o = I_{o, \min}$ to $I_{o, \max}$
$V_o < 2.5V$	-	-	5	mV	
Line Regulation					
$V_o \geq 2.5V$	-	-	0.4	%Vo,set	$V_{IN} = V_{IN, \min}$ to $V_{IN, \max}$
$V_o < 2.5V$	-	-	10	mV	
Temperature Regulation (-40°C to +85°C)	-	-	0.4	%Vo,set	
Ripple and Noise (pk-pk)	-	50	100	mV	5Hz to 20MHz BW, $V_{IN} = V_{IN, \text{nom}}$ and $I_o = I_{o, \min}$ to $I_{o, \max}$ Co = 0.1µF // 10 µF ceramic capacitors)
Ripple and Noise (rms)	-	20	38	mV	
Output Current Range	0	-	6	A	in either sink or source mode
Output DC Current Limit	-	-	200	%Io,max	Hiccup Mode
Output Short-Circuit Current	-	-	170	mA	$V_o \leq 250mV$ , Hiccup Mode
Output Capacitance <sup>2</sup>					
$ESR \geq 1 m\Omega$	0	-	47	µF	Without the Tunable Loop™
$ESR \geq 0.15 m\Omega$	0	-	1000	µF	With the Tunable Loop™
$ESR \geq 10 m\Omega$	0	-	3000	µF	With the Tunable Loop™
Turn-On Delay Time	-	2	-	mS	Case 1: On/Off input is enabled and then input power is applied (delay from instant at which $V_{IN} = V_{IN, \min}$ until $V_o = 10\%$ of $V_o, \text{set}$ )
	-	2	-	mS	Case 2: Input power is applied for at least one second and then the On/Off input is enabled (delay from instant at which $V_{on/Off}$ is enabled until $V_o = 10\%$ of $V_o, \text{set}$ )
Output voltage Rise time	-	4	-	mS	time for $V_o$ to rise from 10% of $V_o, \text{set}$ to 90% of $V_o, \text{set}$
Output voltage overshoot	-	-	3	%Vo,set	$V_{in} = V_{in, \min}$ to $V_{in, \max}$ , $I_o = I_{o, \min}$ to $I_{o, \max}$ , With or without maximum external capacitance

**Notes:** 1. Some output voltages may not be possible depending on the input voltage.

2. External capacitors may require using the new Tunable Loop™ feature to ensure that the module is stable as well as getting the best transient response (See the Tunable Loop™ section for details).

3. Unless otherwise indicated, specifications apply over all operating input voltage, resistive load, and temperature conditions.

# NON-ISOLATED DC/DC CONVERTERS

4.5 Vdc - 14 Vdc Input, 0.59 Vdc - 5.5 Vdc /6 A Outputs



October 8, 2009

*Bel Power, Inc. , a subsidiary of Bel Fuse, Inc.*

## General Specifications

Parameter	Min	Typ	Max	Unit	Notes
Efficiency					
Vo=0.6V	-	69.3	-	%	Vin= 12Vdc, Ta=25°C Io=Io, max , Vo= Vo,set
Vo=1.2V	-	80.7	-	%	
Vo=1.8V	-	85.3	-	%	
Vo=2.5V	-	88.1	-	%	
Vo=3.3V	-	90.8	-	%	
Vo=5.0V	-	93.6	-	%	
Switching Frequency	-	600	-	kHz	
Over Temperature Protection	-	140	-	°C	
Tracking Accuracy					
Power-Up: 2V/ms	-	-	100	mV	Vin, min to Vin, max; Io, min to Io, max
Power-Down: 2V/ms	-	-	100	mV	
PGOOD (Power Good)					
Output Voltage Limit for PGOOD	90	-	110	%Vo,set	Signal Interface Open Drain, Vsupply ≤ 5Vdc
Pulldown resistance of PGOOD pin	-	7	50	Ω	
Weight	-	1.95	-	g	
MTBF		22,280,045		hours	Calculated Per Bell Core SR-332 (Io=0.8Io, max, Ta=40°C, Telecordia Issue 2 Method 1 Case 3)
Dimensions					
Inches (L x W x H)		0.48 x 0.48 x 0.285		-	
Millimeters (L x W x H)		12.19 x 12.19 x 7.25			

**Note:** Unless otherwise indicated, specifications apply over all operating input voltage, resistive load, and temperature conditions.

# NON-ISOLATED DC/DC CONVERTERS

4.5 Vdc - 14 Vdc Input, 0.59 Vdc - 5.5 Vdc / 6 A Outputs



October 8, 2009

Bel Power, Inc., a subsidiary of Bel Fuse, Inc.

## Efficiency Data

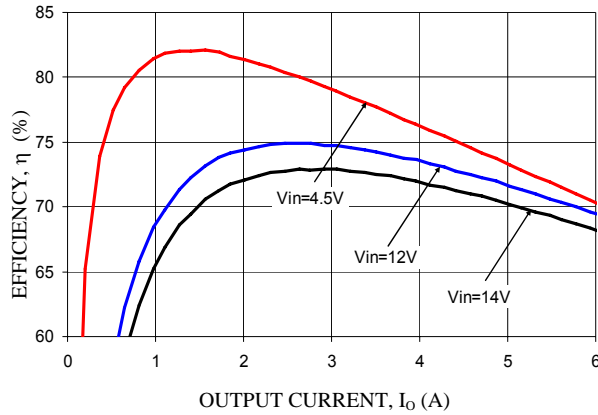

**$V_o=0.6V$**

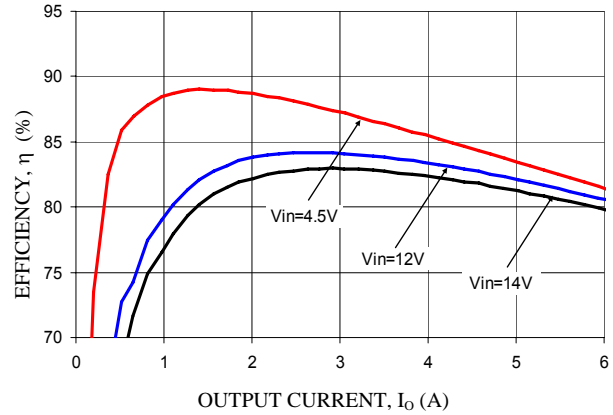

**$V_o=1.2V$**

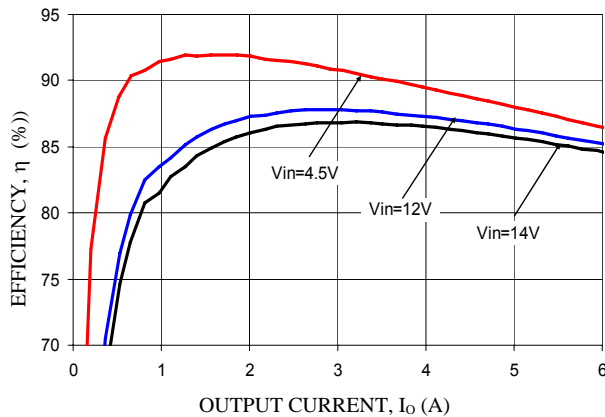

**$V_o=1.8V$**

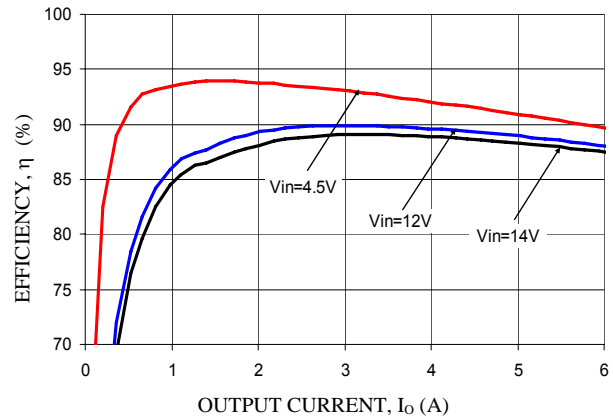

**$V_o=2.5V$**

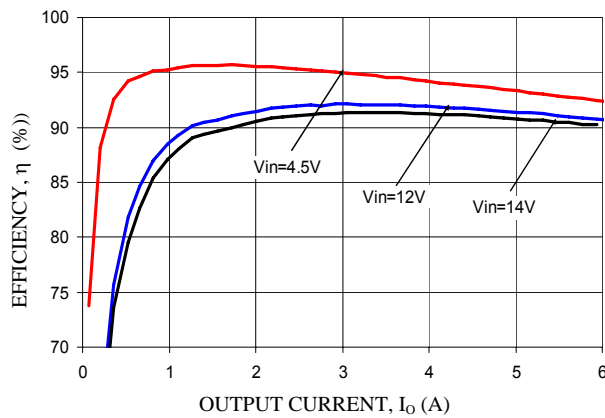

**$V_o=3.3V$**

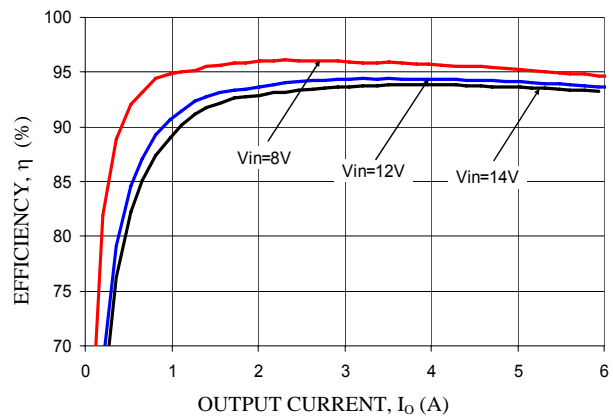

**$V_o=5.0V$**

# NON-ISOLATED DC/DC CONVERTERS

4.5 Vdc - 14 Vdc Input, 0.59 Vdc - 5.5 Vdc / 6 A Outputs



October 8, 2009

Bel Power, Inc., a subsidiary of Bel Fuse, Inc.

## Thermal Derating Curves

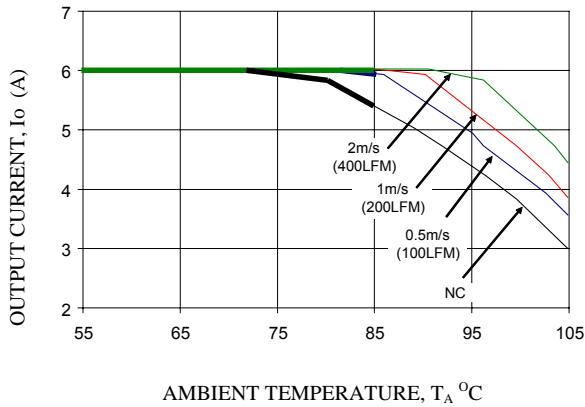

**Vo=0.6V**

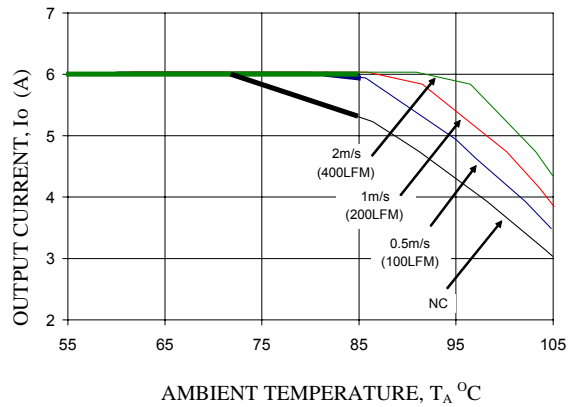

**Vo=1.2V**

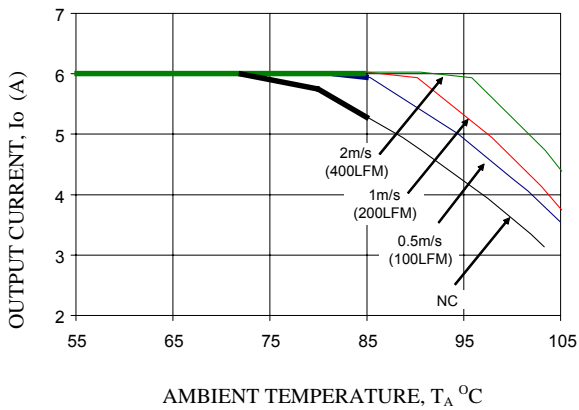

**Vo=1.8V**

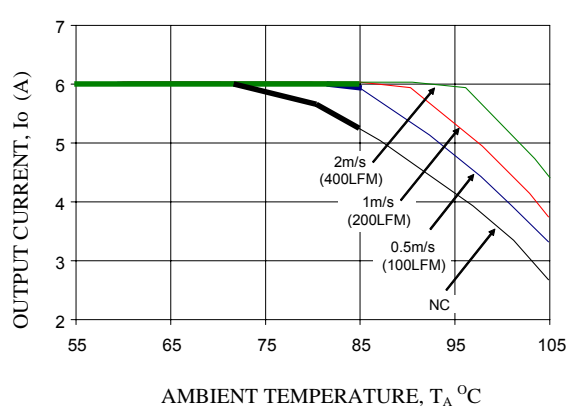

**Vo=2.5V**

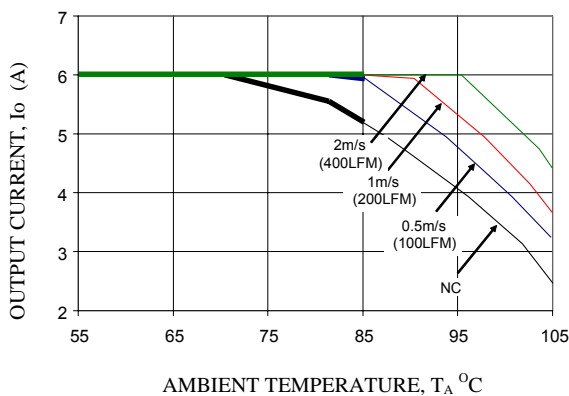

**Vo=3.3V**

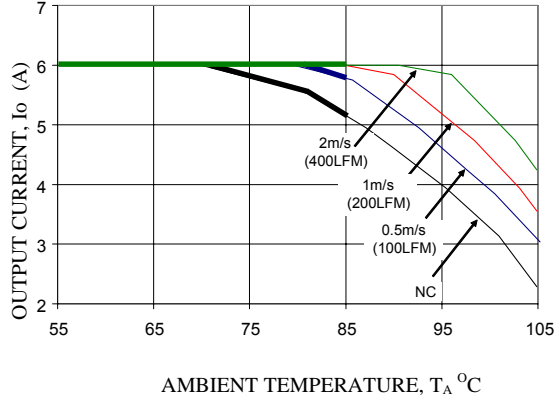

**Vo=5.0V**

# NON-ISOLATED DC/DC CONVERTERS

4.5 Vdc - 14 Vdc Input, 0.59 Vdc - 5.5 Vdc /6 A Outputs



October 8, 2009

Bel Power, Inc., a subsidiary of Bel Fuse, Inc.

## Ripple and Noise Waveforms

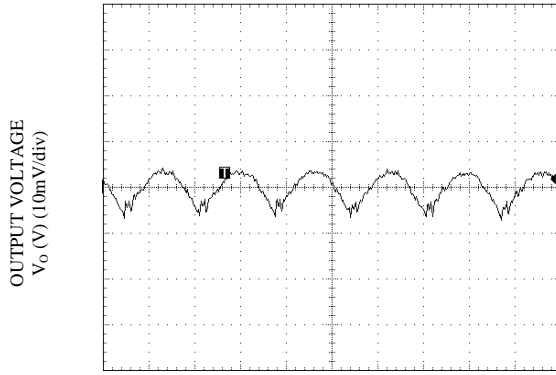

TIME, t (1µs/div)

**Vo=0.6V, Io = Io,max**

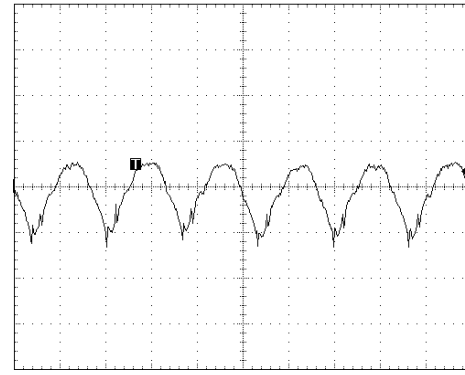

TIME, t (1µs/div)

**Vo=1.2V, Io = Io,max**

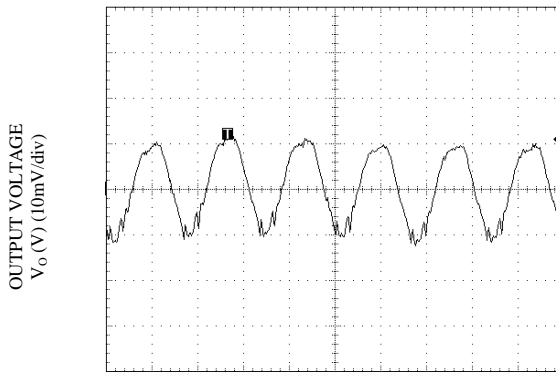

TIME, t (1µs/div)

**Vo=1.8V, Io = Io,max**

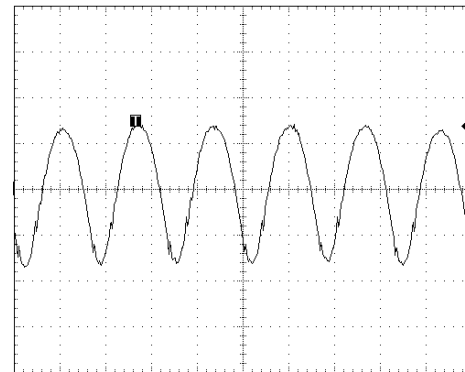

TIME, t (1µs/div)

**Vo=2.5V, Io = Io,max**

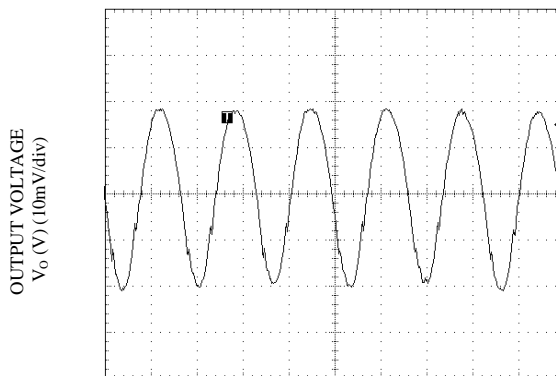

TIME, t (1µs/div)

**Vo=3.3V, Io = Io,max**

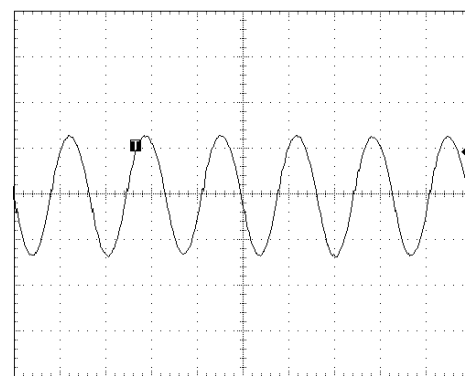

TIME, t (1µs/div)

**Vo=5.0V, Io = Io,max**

# NON-ISOLATED DC/DC CONVERTERS

4.5 Vdc - 14 Vdc Input, 0.59 Vdc - 5.5 Vdc / 6 A Outputs



October 8, 2009

Bel Power, Inc., a subsidiary of Bel Fuse, Inc.

## Transient Response Waveforms

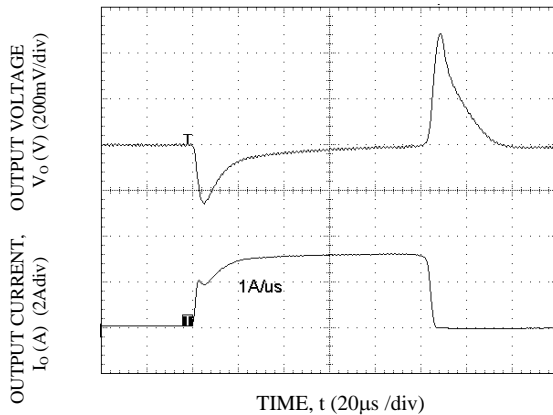

Transient Response to Dynamic Load Change from 0% to 50% to 0%.  $V_o=0.6V$

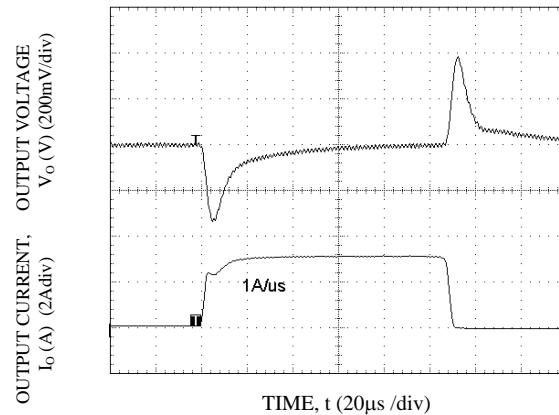

Transient Response to Dynamic Load Change from 0% to 50% to 0%.  $V_o=1.2V$

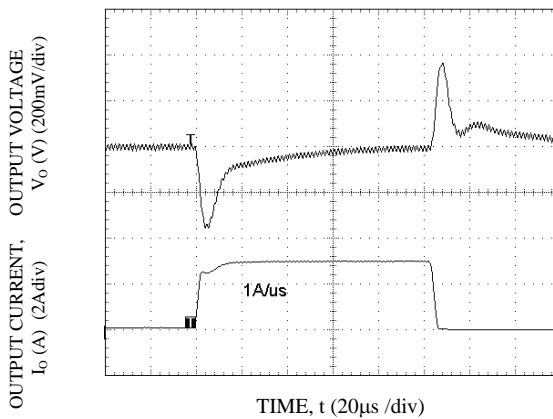

Transient Response to Dynamic Load Change from 0% to 50% to 0%.  $V_o=1.8V$

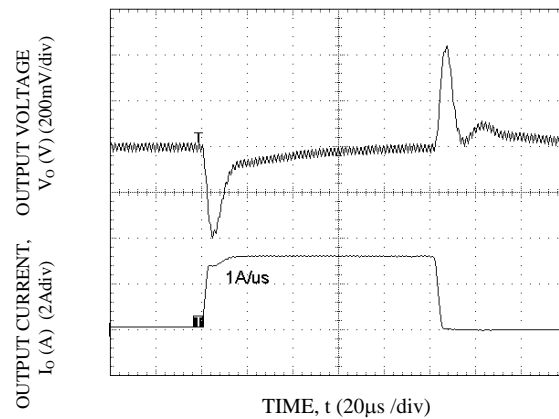

Transient Response to Dynamic Load Change from 0% to 50% to 0%.  $V_o=2.5V$

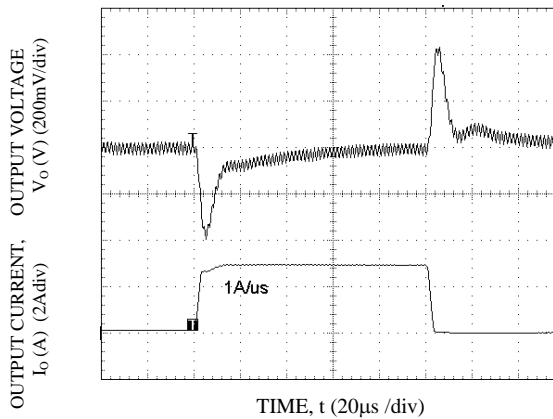

Transient Response to Dynamic Load Change from 0% to 50% to 0%.  $V_o=3.3V$

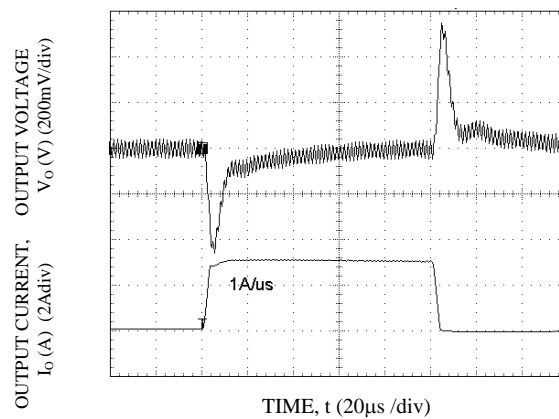

Transient Response to Dynamic Load Change from 0% to 50% to 0%.  $V_o=5.0V$



# NON-ISOLATED DC/DC CONVERTERS

4.5 Vdc - 14 Vdc Input, 0.59 Vdc - 5.5 Vdc /6 A Outputs



October 8, 2009

Bel Power, Inc., a subsidiary of Bel Fuse, Inc.

## Startup Time

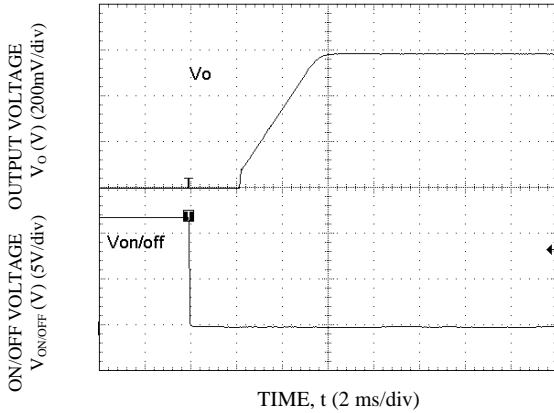

Start-up Using On/Off Voltage ( $I_o = I_{o,max}$ ),  $V_o=0.6V$

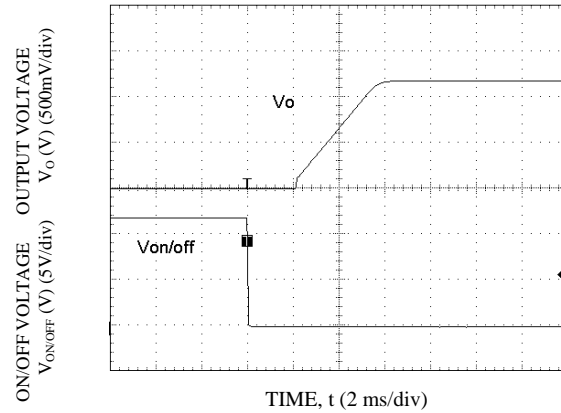

Start-up Using On/Off Voltage ( $I_o = I_{o,max}$ ),  $V_o=1.2V$

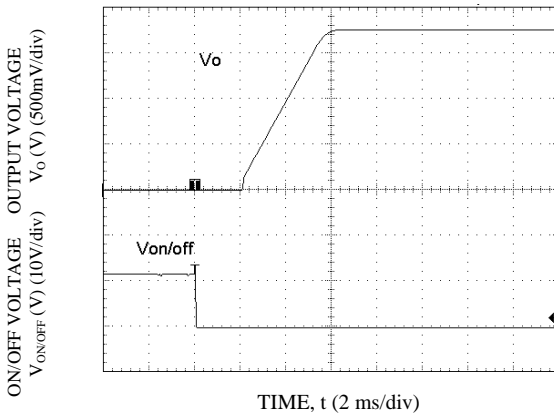

Start-up Using On/Off Voltage ( $I_o = I_{o,max}$ ),  $V_o=1.8V$

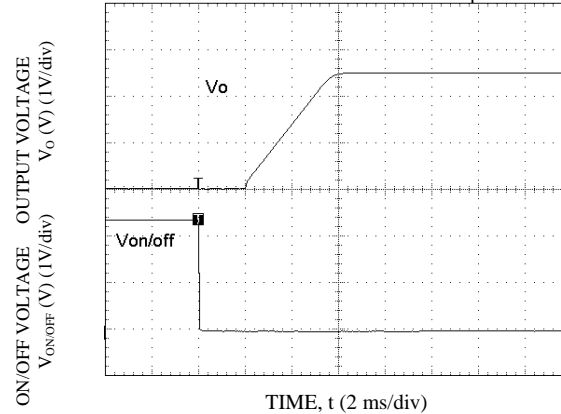

Start-up Using On/Off Voltage ( $I_o = I_{o,max}$ ),  $V_o=2.5V$

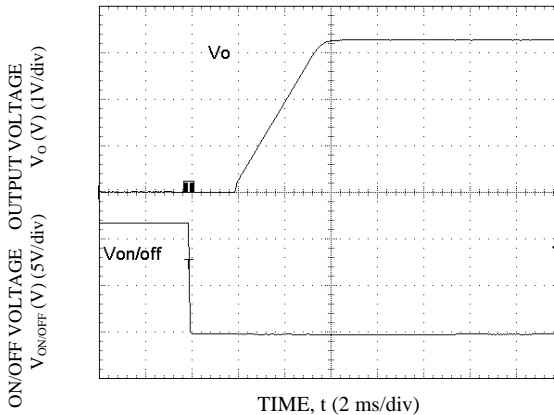

Start-up Using On/Off Voltage ( $I_o = I_{o,max}$ ),  $V_o=3.3V$

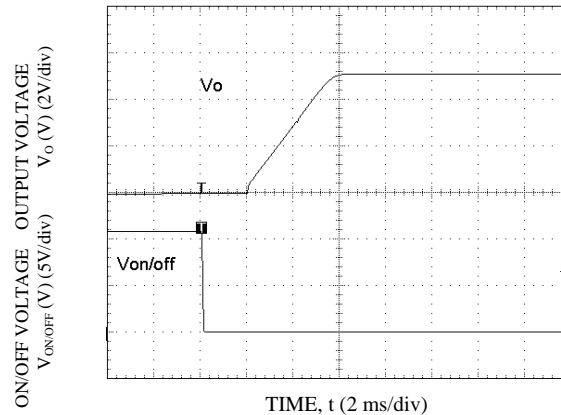

Start-up Using On/Off Voltage ( $I_o = I_{o,max}$ ),  $V_o=5.0V$

# NON-ISOLATED DC/DC CONVERTERS

4.5 Vdc - 14 Vdc Input, 0.59 Vdc - 5.5 Vdc /6 A Outputs



October 8, 2009

Bel Power, Inc., a subsidiary of Bel Fuse, Inc.

## Startup Time (continued)

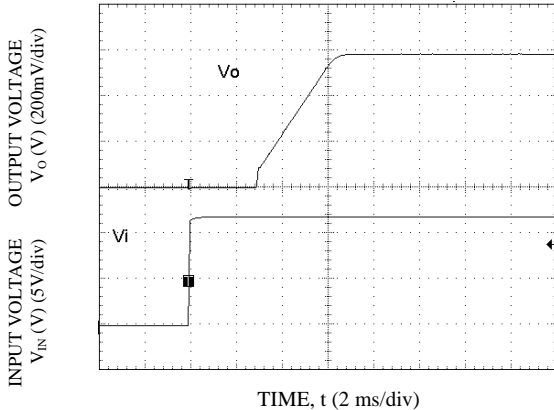

Start-up Using Input Voltage ( $V_{IN} = 12V$ ,  $I_o = I_{o,max}$ ),  $V_o = 0.6V$

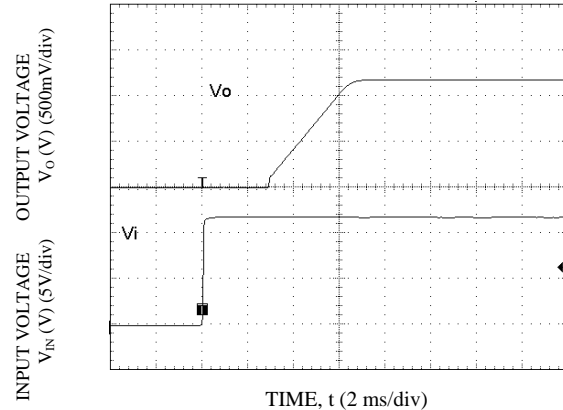

Start-up Using Input Voltage ( $V_{IN} = 12V$ ,  $I_o = I_{o,max}$ ),  $V_o = 1.2V$

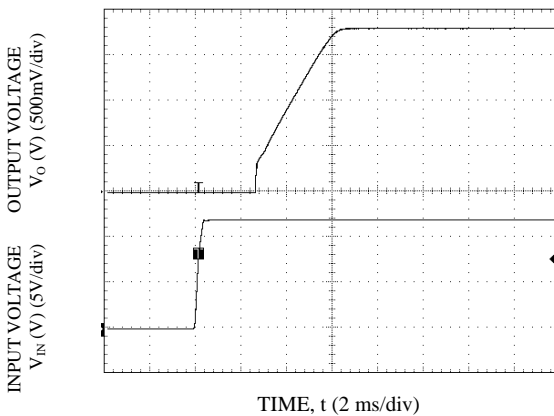

Start-up Using Input Voltage ( $V_{IN} = 12V$ ,  $I_o = I_{o,max}$ ),  $V_o = 1.8V$

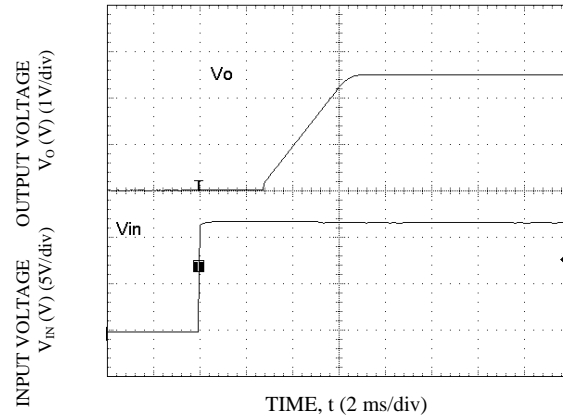

Start-up Using Input Voltage ( $V_{IN} = 12V$ ,  $I_o = I_{o,max}$ ),  $V_o = 2.5V$

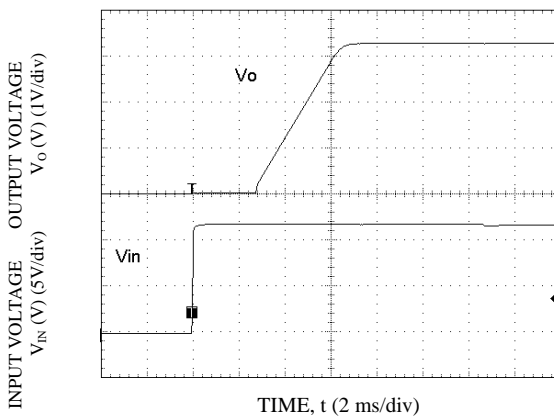

Start-up Using Input Voltage ( $V_{IN} = 12V$ ,  $I_o = I_{o,max}$ ),  $V_o = 3.3V$

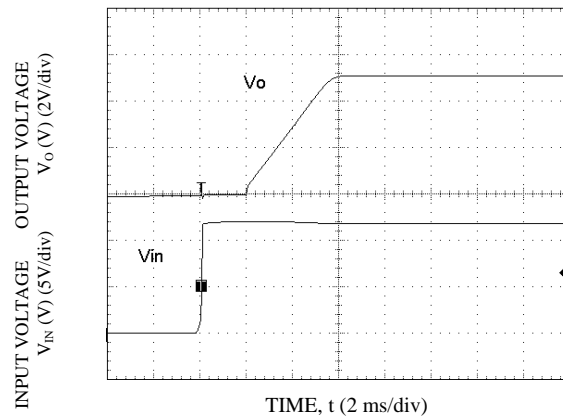

Start-up Using Input Voltage ( $V_{IN} = 12V$ ,  $I_o = I_{o,max}$ ),  $V_o = 5.0V$

# NON-ISOLATED DC/DC CONVERTERS

4.5 Vdc - 14 Vdc Input, 0.59 Vdc - 5.5 Vdc / 6 A Outputs



October 8, 2009

Bel Power, Inc., a subsidiary of Bel Fuse, Inc.

## Test Configurations

### Input Reflected Ripple Current Test Setup.

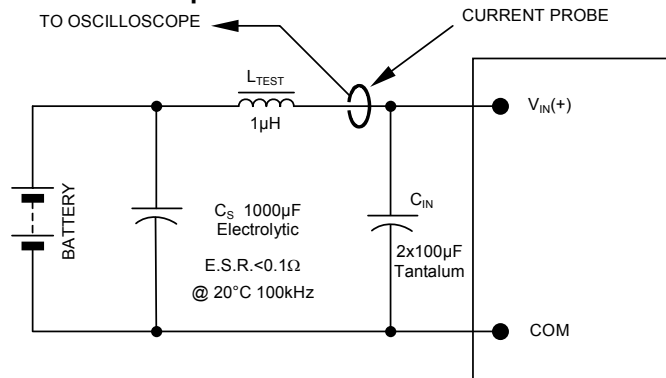

NOTE: Measure input reflected ripple current with a simulated source inductance ( $L_{TEST}$ ) of 1µH. Capacitor  $C_S$  offsets possible battery impedance. Measure current as shown above.

### Output Ripple and Noise Test Setup

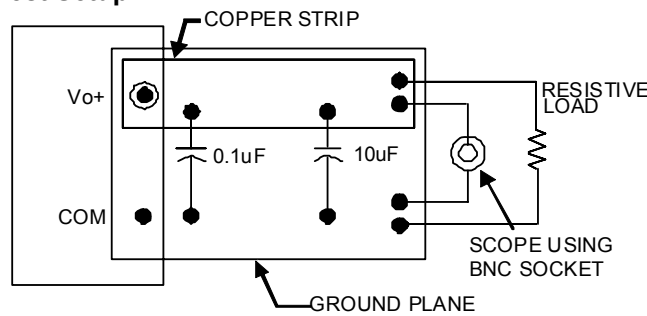

NOTE: All voltage measurements to be taken at the module terminals, as shown above. If sockets are used then Kelvin connections are required at the module terminals to avoid measurement errors due to socket contact resistance.

### Output Voltage and Efficiency Test Setup

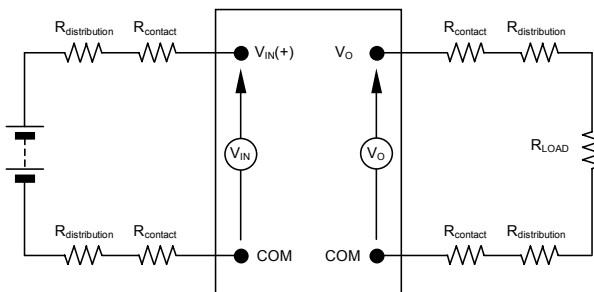

NOTE: All voltage measurements to be taken at the module terminals, as shown above. If sockets are used then Kelvin connections are required at the module terminals to avoid measurement errors due to socket contact resistance.

$$\text{Efficiency } \eta = \frac{V_O \cdot I_O}{V_{IN} \cdot I_{IN}} \times 100 \%$$

## Input Filtering

The SLIN-06E2Ax module should be connected to a low ac-impedance source. A highly inductive source can affect the stability of the module. Input capacitance must be placed directly adjacent to the input pin of the module, to minimize input ripple voltage and ensure module stability.

To minimize input voltage ripple, ceramic capacitors are recommended at the input of the module. Below figure shows the input ripple voltage for various output voltages at 6A of load current with 1x10  $\mu$ F or 1x22  $\mu$ F ceramic capacitors and an input of 12V.

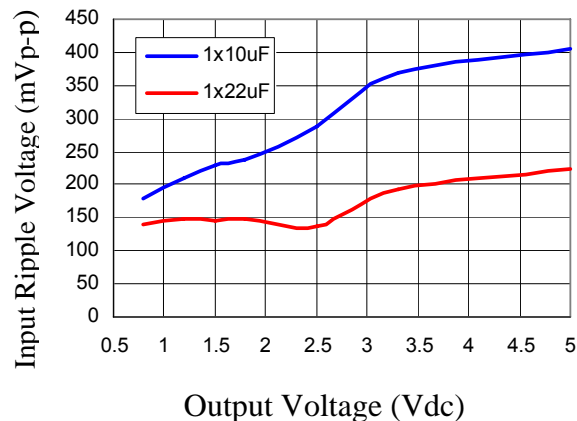

**Note:** Input ripple voltage for various output voltages with 1x10  $\mu$ F or 1x22  $\mu$ F ceramic capacitors at the input (6A load). Input voltage is 12V.

## Output Filtering

The SLIN-06E2Ax modules are designed for low output ripple voltage and will meet the maximum output ripple specification with 0.1  $\mu$ F ceramic and 10  $\mu$ F ceramic capacitors at the output of the module. However, additional output filtering may be required by the system designer for a number of reasons. First, there may be a need to further reduce the output ripple and noise of the module. Second, the dynamic response characteristics may need to be customized to a particular load step change.

To reduce the output ripple and improve the dynamic response to a step load change, additional capacitance at the output can be used. Low ESR polymer and ceramic capacitors are recommended to improve the dynamic response of the module. Below figure provides output ripple information for different external capacitance values at various  $V_o$  and for a load current of 6A. For stable operation of the module, limit the capacitance to less than the maximum output capacitance as specified in the electrical specification table. Optimal performance of the module can be achieved by using the Tunable Loop™ feature described later in this data sheet.

## NON-ISOLATED DC/DC CONVERTERS

4.5 Vdc - 14 Vdc Input, 0.59 Vdc - 5.5 Vdc /6 A Outputs



October 8, 2009

*Bel Power, Inc., a subsidiary of Bel Fuse, Inc.*

### Output Filtering (continued)

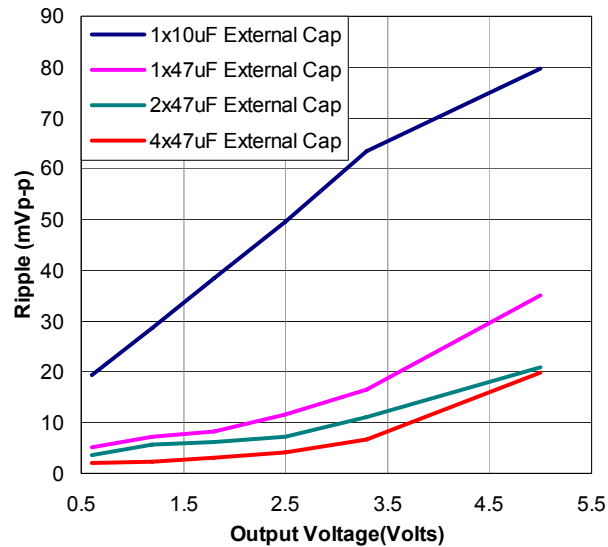

**Note:** Output ripple voltage for various output voltages with external 1x10  $\mu$ F, 1x47  $\mu$ F, 2x47  $\mu$ F or 4x47  $\mu$ F ceramic capacitors at the output (6A load). Input voltage is 12V.

### Safety Considerations

For safety agency approval the power module must be installed in compliance with the spacing and separation requirements of the end-use safety agency standards, i.e., UL 60950-1, CSA C22.2 No. 60950-1-03, and VDE 0850:2001-12 (EN60950-1) Licensed.

For the converter output to be considered meeting the requirements of safety extra-low voltage (SELV), the input must meet SELV requirements. The power module has extra-low voltage (ELV) outputs when all inputs are ELV. The input to these units is to be provided with a fast-acting fuse with a maximum rating of 6A in the positive input lead.

# NON-ISOLATED DC/DC CONVERTERS

4.5 Vdc - 14 Vdc Input, 0.59 Vdc - 5.5 Vdc /6 A Outputs



October 8, 2009

Bel Power, Inc., a subsidiary of Bel Fuse, Inc.

## Remote On/Off

Parameter		Min	Typ	Max	Unit	Notes
Signal Low (Unit On)	Active Low	-0.2	-	0.3	V	The remote on/off pin open, Unit off.
Signal High (Unit Off)		3.5	-	V <sub>in,max</sub>	V	
Signal Low (Unit Off)	Active High	-0.3	-	0.8	V	The remote on/off pin open, Unit on.
Signal High (Unit On)		3.5	-	V <sub>in,max</sub>	V	

The SLIN-06E2Ax power modules feature an On/Off pin for remote On/Off operation. Two On/Off logic options are available. In the Positive Logic On/Off option, the module turns ON during a logic High on the On/Off pin and turns OFF during a logic Low. With the Negative Logic On/Off option, the module turns OFF during logic High and ON during logic Low. The On/Off signal is always referenced to ground. For either On/Off logic option, leaving the On/Off pin disconnected will turn the module ON when input voltage is present.

For positive logic modules, the circuit configuration for using the On/Off pin is shown in below figure. When the external transistor Q1 is in the OFF state, the internal PWM Enable signal is pulled high through an internal 1.5MΩ resistor and the external pullup resistor and the module is ON. When transistor Q1 is turned ON, the On/Off pin is pulled low and the module is OFF. A suggested value for R<sub>pullup</sub> is 20kΩ.

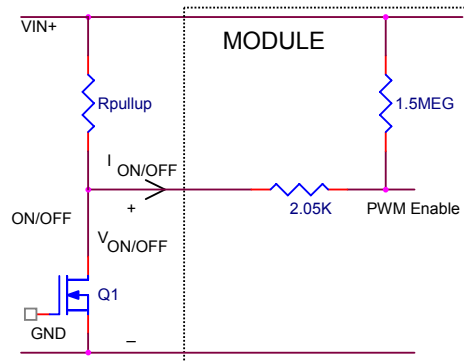

Circuit configuration for using positive On/Off logic

For negative logic On/Off modules, the circuit configuration is shown in below. The On/Off pin should be pulled high with an external pull-up resistor (suggested value for the 4.5V to 14V input range is 20Kohms). When transistor Q2 is in the OFF state, the On/Off pin is pulled high, transistor Q1 is turned ON and the module is OFF. To turn the module ON, Q2 is turned ON pulling the On/Off pin low, turning transistor Q1 OFF resulting in the PWM Enable pin going high.

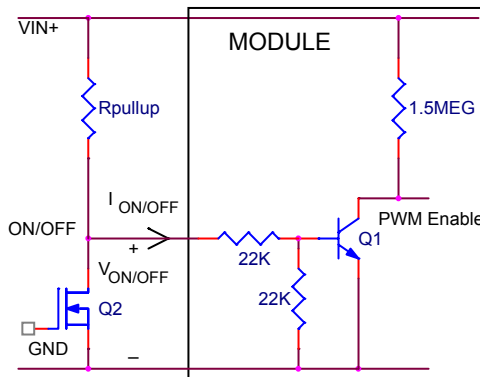

Circuit configuration for using negative On/Off logic

# NON-ISOLATED DC/DC CONVERTERS

4.5 Vdc - 14 Vdc Input, 0.59 Vdc - 5.5 Vdc /6 A Outputs



October 8, 2009

*Bel Power, Inc., a subsidiary of Bel Fuse, Inc.*

## Over Current Protection

To provide protection in a fault (output overload) condition, the unit is equipped with internal current-limiting circuitry and can endure current limiting continuously. At the point of current-limit inception, the unit enters hiccup mode. The unit operates normally once the output current is brought back into its specified range.

## Over Temperature Protection

To provide protection in a fault condition, the unit is equipped with a thermal shutdown circuit. The unit will shutdown if the over temperature threshold of 140°C is exceeded at the thermal reference point Tref. The thermal shutdown is not intended as a guarantee that the unit will survive temperatures beyond its rating. Once the unit goes into thermal shutdown it will then wait to cool before attempting to restart.

## Input Under-voltage Lockout

At input voltages below the input under voltage lockout limit, the module operation is disabled. The module will begin to operate at an input voltage above the under voltage lockout turn-on threshold.

## Output Voltage Programming

The output voltage of the SLIN-06E2Ax modules can be programmed to any voltage from 0.59Vdc to 5.5Vdc by connecting a resistor between the Trim and GND pins of the module. Certain restrictions apply on the output voltage set point depending on the input voltage. These are shown in below. The Limit curve shows that for output voltages of 0.9V and lower, the input voltage must be lower than the maximum of 14V. The Lower Limit curve shows that for output voltages of 3.8V and higher, the input voltage needs to be larger than the minimum of 4.5V.

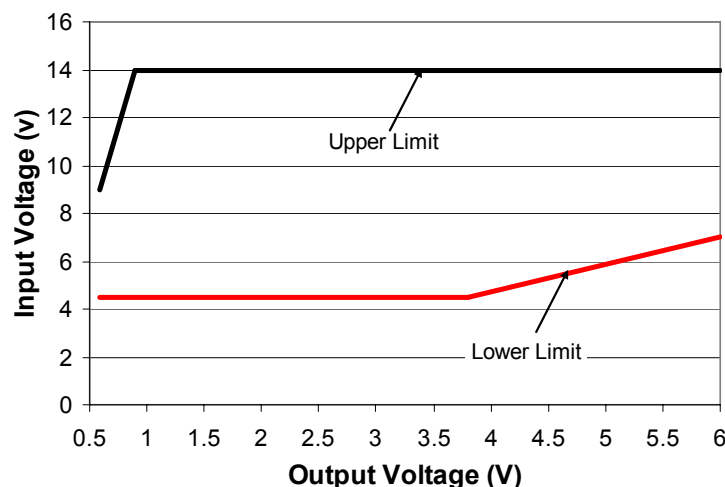

Output Voltage vs. Input Voltage Set Point Area plot showing limits where the output voltage can be set for different input voltages.

October 8, 2009

*Bel Power, Inc., a subsidiary of Bel Fuse, Inc.*

## Output Trim Equations

Without an external resistor between Trim and GND pins, the output of the module will be 0.59Vdc. To calculate the value of the trim resistor,  $R_{trim}$  for a desired output voltage, use the following equation:

$$R_{trim} = \left[ \frac{5.91}{(V_o - 0.591)} \right] k\Omega$$

$R_{trim}$  is the external resistor in  $k\Omega$   
 $V_o$  is the desired output voltage.

Table 1 provides  $R_{trim}$  values required for some common output voltages.

**Table 1**

$V_{O, set}$ (V)	$R_{trim}$ (K $\Omega$ )
0.6	656.7
1.0	14.45
1.2	9.704
1.5	6.502
1.8	4.888
2.5	3.096
3.3	2.182
5.0	1.340

By using a  $\pm 0.5\%$  tolerance trim resistor with a TC of  $\pm 100\text{ppm}$ , a set point tolerance of  $\pm 1.5\%$  can be achieved as specified in the electrical specification.

## Remote Sense

The SLIN-06E2Ax power modules have a Remote Sense feature to minimize the effects of distribution losses by regulating the voltage at the SENSE pin. The voltage between the SENSE pin and VOUT pin must not exceed 0.5V. Note that the output voltage of the module cannot exceed the specified maximum value. This includes the voltage drop between the SENSE and Vout pins. When the Remote Sense feature is not being used, connect the SENSE pin to the VOUT pin.

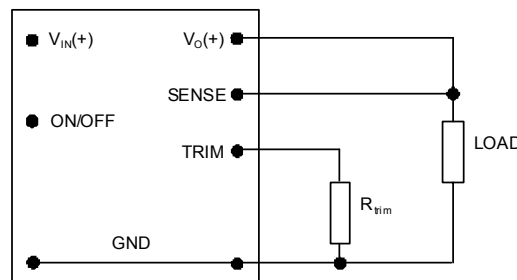

Circuit configuration for programming output voltage using an external resistor



## NON-ISOLATED DC/DC CONVERTERS

4.5 Vdc - 14 Vdc Input, 0.59 Vdc - 5.5 Vdc /6 A Outputs



October 8, 2009

*Bel Power, Inc., a subsidiary of Bel Fuse, Inc.*

### Voltage Margining

Output voltage margining can be implemented in the SLIN-06E2Ax modules by connecting a resistor,  $R_{\text{margin-up}}$ , from the Trim pin to the ground pin for margining-up the output voltage and by connecting a resistor,  $R_{\text{margin-down}}$ , from the Trim pin to output pin for margining-down.

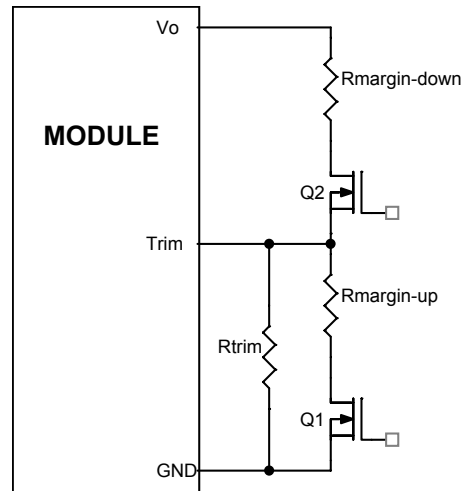

Circuit Configuration for margining Output voltage

### Monotonic Start-up and Shutdown

The SLIN-06E2Ax modules have monotonic start-up and shutdown behavior for any combination of rated input voltage, output current and operating temperature range.

### Startup into Pre-biased Output

The SLIN-06E2Ax modules can start into a prebiased output as long as the prebias voltage is 0.5V less than the set output voltage.

# NON-ISOLATED DC/DC CONVERTERS

4.5 Vdc - 14 Vdc Input, 0.59 Vdc - 5.5 Vdc /6 A Outputs



October 8, 2009  
Power Good

*Bel Power, Inc., a subsidiary of Bel Fuse, Inc.*

The SLIN-06E2Ax provide a Power Good (PGOOD) signal that is implemented with an open-drain output to indicate that the output voltage is within the regulation limits of the power module. The PGOOD signal will be de-asserted to a low state if any condition such as over temperature, over current or loss of regulation occurs that would result in the output voltage going  $\pm 10\%$  outside the set-point value. The PGOOD terminal should be connected through a pull-up resistor (suggested value 100K $\Omega$ ) to a source of 5VDC or lower.



## Tunable Loop™

The SLIN-06E2Ax modules have a new feature that optimizes transient response of the module called Tunable Loop™.

External capacitors are usually added to the output of the module for two reasons: to reduce output ripple and noise and to reduce output voltage deviations from the steady-state value in the presence of dynamic load current changes. Adding external capacitance however affects the voltage control loop of the module, typically causing the loop to slow down with sluggish response. Larger values of external capacitance could also cause the module to become unstable.

The Tunable Loop™ allows the user to externally adjust the voltage control loop to match the filter network connected to the output of the module. The Tunable Loop™ is implemented by connecting a series R-C between the SENSE and TRIM pins of the module, as shown in below. This R-C allows the user to externally adjust the voltage loop feedback compensation of the module.

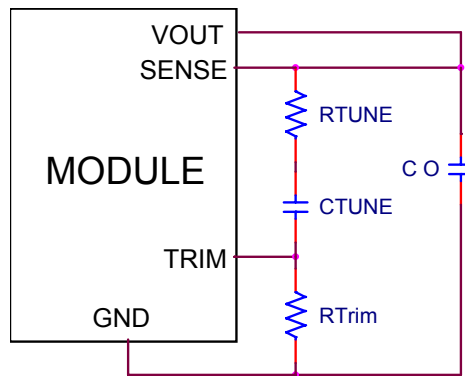

Circuit diagram showing connection of  $R_{TUNE}$  and  $C_{TUNE}$  to tune the control loop of the module

Recommended values of  $R_{TUNE}$  and  $C_{TUNE}$  for different output capacitor combinations are given in below Tables 2 and 3. Table 2 shows the recommended values of  $R_{TUNE}$  and  $C_{TUNE}$  for different values of ceramic output capacitors up to 470uF that might be needed for an application to meet output ripple and noise requirements. Selecting  $R_{TUNE}$  and  $C_{TUNE}$  according to Table 2 will ensure stable operation of the module.

In applications with tight output voltage limits in the presence of dynamic current loading, additional output capacitance will be required. Table 3 lists recommended values of  $R_{TUNE}$  and  $C_{TUNE}$  in order to meet 2% output voltage deviation limits for some common output voltages in the presence of a 3A to 6A step change (50% of full load), with an input voltage of 12V.

# NON-ISOLATED DC/DC CONVERTERS

4.5 Vdc - 14 Vdc Input, 0.59 Vdc - 5.5 Vdc /6 A Outputs



October 8, 2009

Bel Power, Inc., a subsidiary of Bel Fuse, Inc.

## Tunable Loop™ (Continued)

**Table 2.** General recommended values of  $R_{TUNE}$  and  $C_{TUNE}$  for  $V_{in}=12V$  and various external ceramic capacitor combinations.

$C_o$	1x47 $\mu$ F	2x47 $\mu$ F	4x47 $\mu$ F	6x47 $\mu$ F	10x47 $\mu$ F
$R_{TUNE}$	270	220	150	75	75
$C_{TUNE}$	2200pF	4700pF	8200pF	12nF	18nF

**Table 3.** Recommended values of  $R_{TUNE}$  and  $C_{TUNE}$  to obtain transient deviation of  $\leq 2\%$  of  $V_{out}$  for a 3A step load with  $V_{in}=12V$ .

$V_o$	5V	3.3V	2.5V	1.8V	1.2V	0.6V
$C_o$	2x47 $\mu$ F	3x47 $\mu$ F	4x47 $\mu$ F	6x47 $\mu$ F	2x47 $\mu$ F+330 $\mu$ F Polymer	3 x330 $\mu$ F Polymer
$R_{TUNE}$	220	180	150	120	100	100
$C_{TUNE}$	3900pF	6800pF	10nF	12nF	15nF	120nF
$\Delta V$	87mV	57mV	43mV	32mV	23mV	12mV

## Thermal Considerations

Power modules operate in a variety of thermal environments; however, sufficient cooling should always be provided to help ensure reliable operation.

Considerations include ambient temperature, airflow, module power dissipation, and the need for increased reliability. A reduction in the operating temperature of the module will result in an increase in reliability. The thermal data presented here is based on physical measurements taken in a wind tunnel.

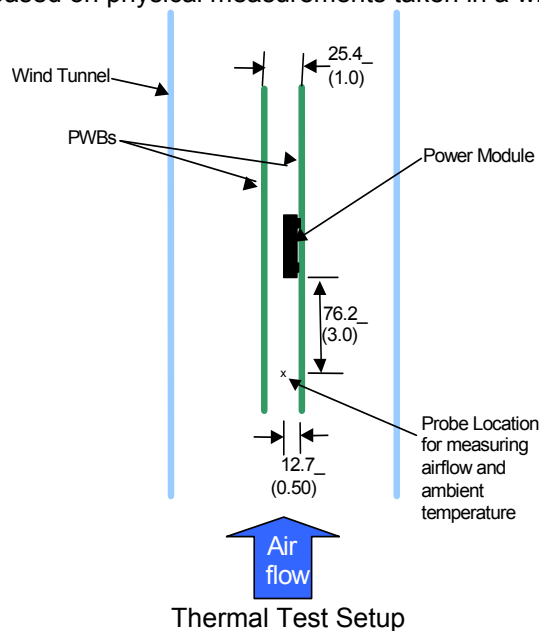

# NON-ISOLATED DC/DC CONVERTERS

4.5 Vdc - 14 Vdc Input, 0.59 Vdc - 5.5 Vdc /6 A Outputs



October 8, 2009

Bel Power, Inc., a subsidiary of Bel Fuse, Inc.

## Thermal Considerations (continued)

The thermal reference points,  $T_{ref}$  used in the specifications are also shown in below. For reliable operation the temperatures at these points should not exceed 120°C. The output power of the module should not exceed the rated power of the module ( $V_{o,set} \times I_{o,max}$ ).

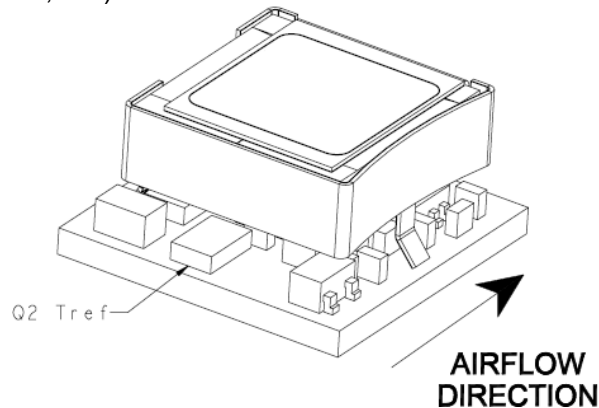

Preferred airflow direction and location of hot-spot of the module ( $T_{ref}$ ).

## Example Application Circuit

### Requirements:

$V_{in}$ : 12V  
 $V_{out}$ : 1.8V  
 $I_{out}$ : 4.5A max., worst case load transient is from 3A to 4.5A  
 $\Delta V_{out}$ : 1.5% of  $V_{out}$  (27mV) for worst case load transient  
 $V_{in}$ , ripple: 1.5% of  $V_{in}$  (50mV, p-p)

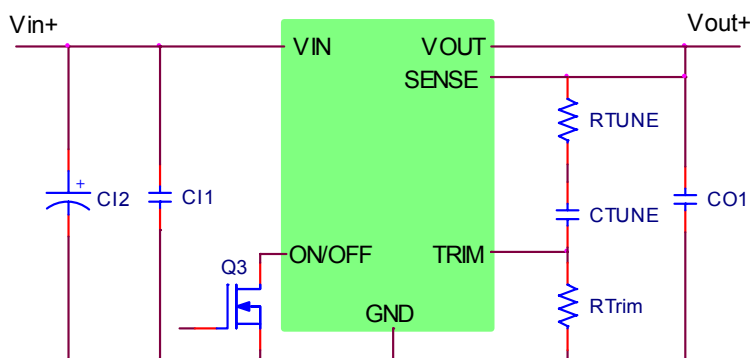

- C11 22 $\mu$ F/16V ceramic capacitor (e.g. Murata GRM32ER61C226KE20)
- C12 47 $\mu$ F/16V bulk electrolytic
- CO1 5 x 47 $\mu$ F/6.3V ceramic capacitor (e.g. Murata GRM31CR60J476ME19)
- CTune 12nF ceramic capacitor (can be 1206, 0805 or 0603 size)
- RTune 120 ohms SMT resistor (can be 1206, 0805 or 0603 size)
- RTrim 4.87k $\Omega$  SMT resistor (can be 1206, 0805 or 0603 size, recommended tolerance of 0.1%)

# NON-ISOLATED DC/DC CONVERTERS

4.5 Vdc - 14 Vdc Input, 0.59 Vdc - 5.5 Vdc /6 A Outputs



October 8, 2009

Bel Power, Inc., a subsidiary of Bel Fuse, Inc.

## Mechanical Outline

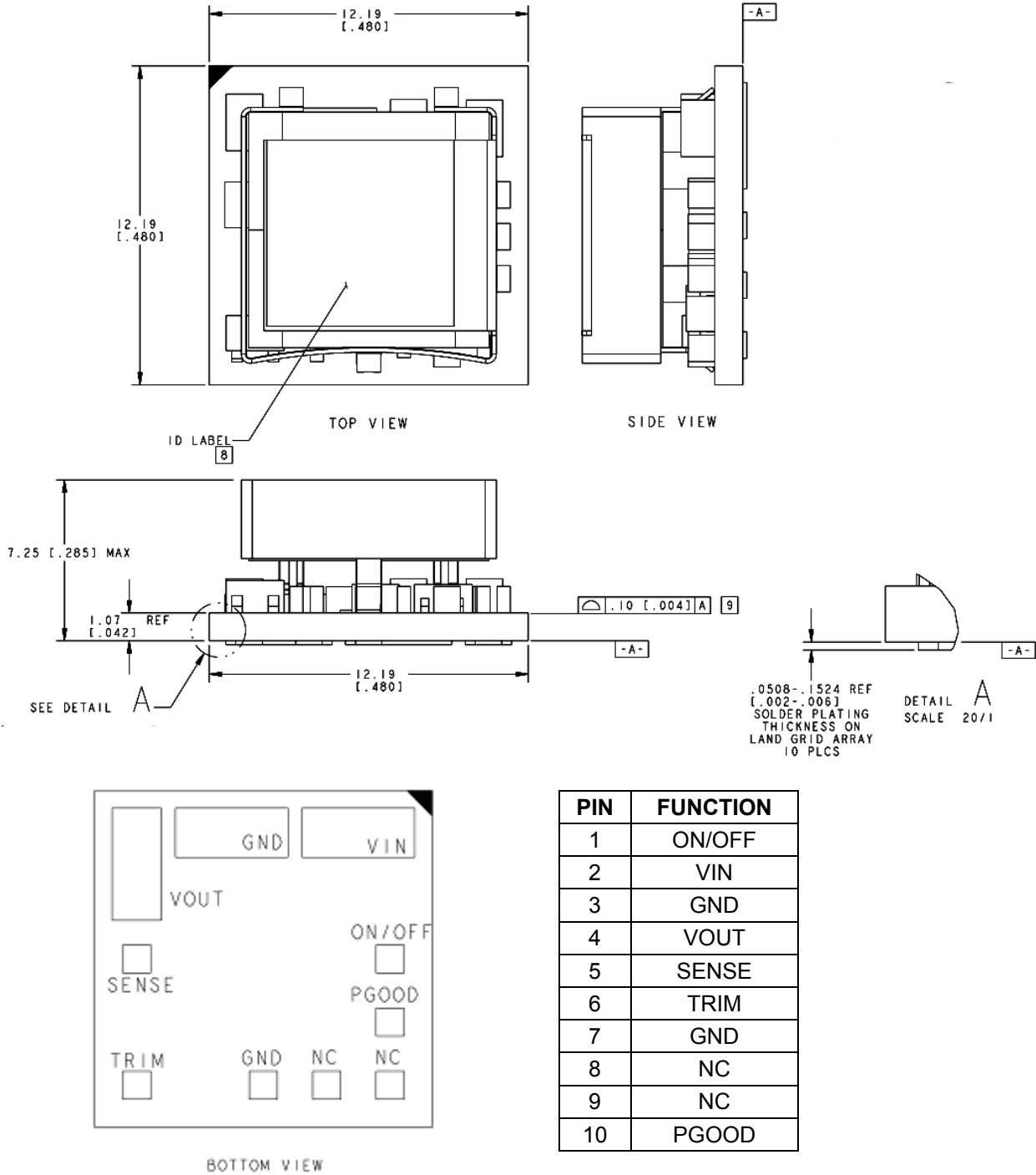

# NON-ISOLATED DC/DC CONVERTERS

4.5 Vdc - 14 Vdc Input, 0.59 Vdc - 5.5 Vdc /6 A Outputs



October 8, 2009

Bel Power, Inc., a subsidiary of Bel Fuse, Inc.

## Mechanical Outline (continued)

### Recommended Pad Layout

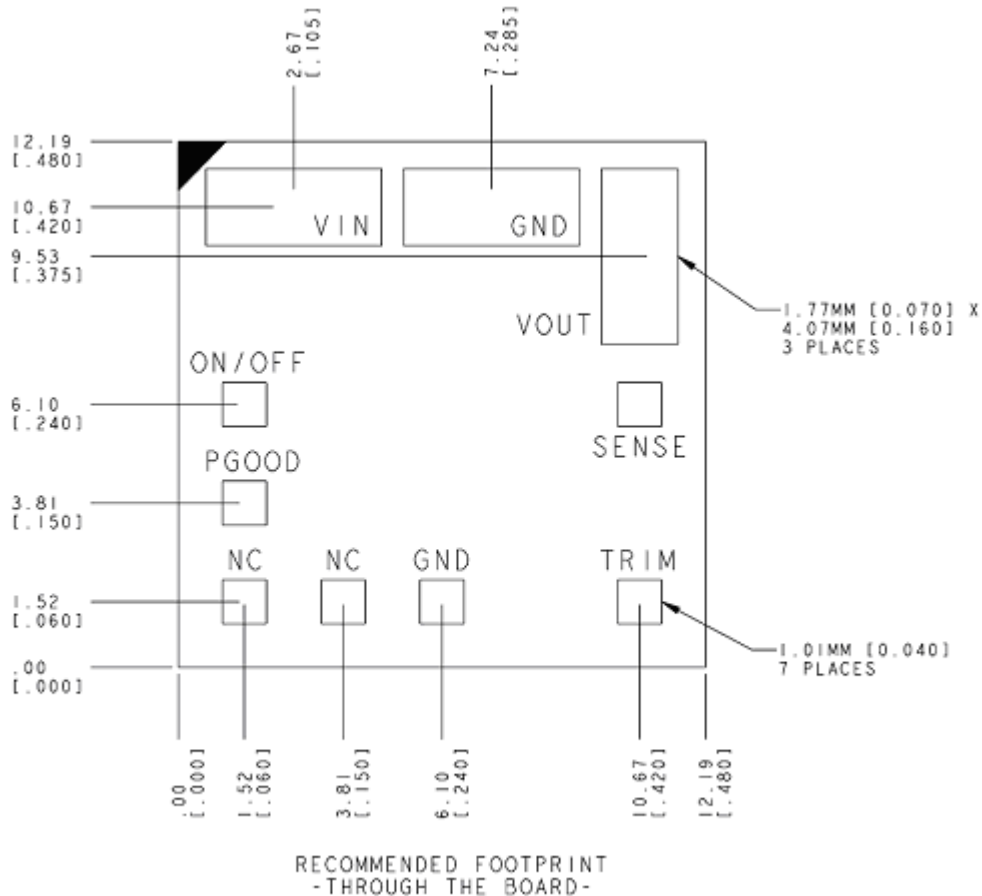

Dimensions are in millimeters and (inches).

Tolerances: x.x mm  $\pm$  0.5 mm (x.xx in.  $\pm$  0.02 in.) [unless otherwise indicated]

x.xx mm  $\pm$  0.25 mm (x.xxx in  $\pm$  0.010 in.)

**Note: This module is recommended and compatible with Pb-Free Reflow Soldering and must be soldered using a reflow profile with a peak temperature of no more than 260 °C for less than 5 seconds.**

# NON-ISOLATED DC/DC CONVERTERS

4.5 Vdc - 14 Vdc Input, 0.59 Vdc - 5.5 Vdc /6 A Outputs



October 8, 2009  
Packaging Details

*Bel Power, Inc., a subsidiary of Bel Fuse, Inc.*

The SLIN-06E2Ax modules are supplied in tape & reel as standard. Modules are shipped in quantities of 400 modules per reel.

All Dimensions are in millimeters and (in inches).

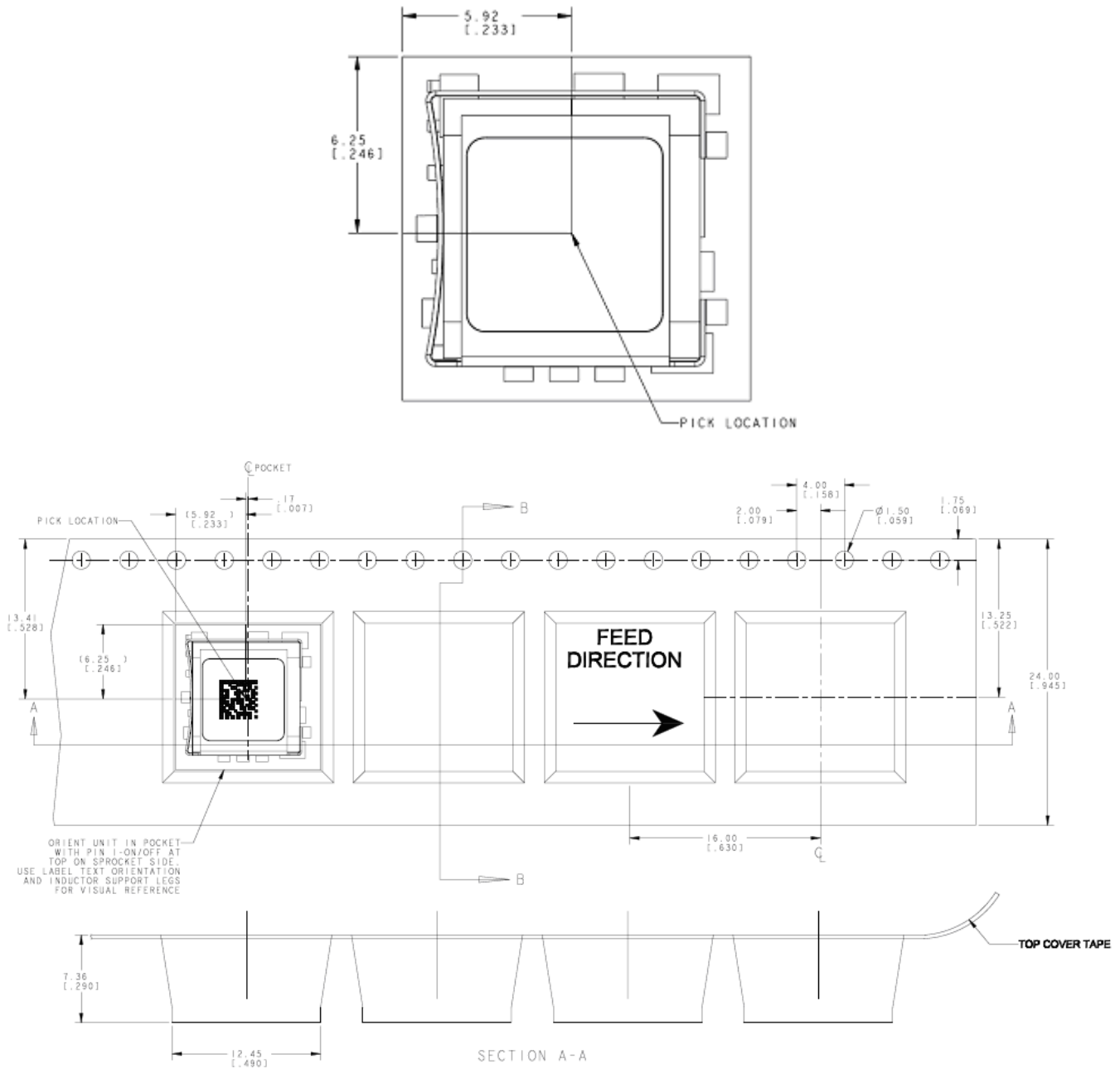

Reel Dimensions:  
Outside Dimensions: 330.2 mm (13.00")  
Inside Dimensions: 177.8 mm (7.00")  
Tape Width: 24.00 mm (0.945")

# NON-ISOLATED DC/DC CONVERTERS

4.5 Vdc - 14 Vdc Input, 0.59 Vdc - 5.5 Vdc /6 A Outputs



October 8, 2009

*Bel Power, Inc., a subsidiary of Bel Fuse, Inc.*

## Surface Mount Information

### Pick and Place

The SLIN-06E2Ax modules use an open frame construction and are designed for a fully automated assembly process. The modules are fitted with a label designed to provide a large surface area for pick and place operations. The label meets all the requirements for surface mount processing, as well as safety standards, and is able to withstand reflow temperatures of up to 300°C. The label also carries product information such as part number and serial number.

### Nozzle Recommendations

The module weight has been kept to a minimum by using open frame construction. Variables such as nozzle size, tip style, vacuum pressure and placement speed should be considered to optimize this process. The minimum recommended inside nozzle diameter for reliable operation is 3mm. The maximum nozzle outer diameter, which will safely fit within the allowable component spacing, is 7 mm.

### Lead Free Soldering

The SLIN-06E2Ax modules are lead-free (Pb-free) and RoHS compliant and fully compatible in a Pb-free soldering process. Failure to observe the instructions below may result in the failure of or cause damage to the modules and can adversely affect long-term reliability.

### Pb-Free Reflow Profile

Power Systems will comply with J-STD-020 Rev. C (Moisture/Reflow Sensitivity Classification for Nonhermetic Solid State Surface Mount Devices) for both Pb-free solder profiles and MSL classification procedures. This standard provides a recommended forced-air-convection reflow profile based on the volume and thickness of the package. The suggested Pb-free solder paste is Sn/Ag/Cu (SAC). The recommended linear reflow profile using Sn/Ag/Cu solder is shown in the figure below. Soldering outside of the recommended profile requires testing to verify results and performance.

### MSL Rating

The SLIN-06E2Ax modules have a MSL rating of 2.

### Storage and Handling

The recommended storage environment and handling procedures for moisture-sensitive surface mount packages is detailed in J-STD-033 Rev. A (Handling, Packing, Shipping and Use of Moisture/Reflow Sensitive Surface Mount Devices). Moisture barrier bags (MBB) with desiccant are required for MSL ratings of 2 or greater. These sealed packages should not be broken until time of use. Once the original package is broken, the floor life of the product at conditions of  $\leq 30^{\circ}\text{C}$  and 60% relative humidity varies according to the MSL rating (see J-STD-033A). The shelf life for dry packed SMT packages will be a minimum of 12 months from the bag seal date, when stored at the following conditions:  $< 40^{\circ}\text{C}$ ,  $< 90\%$  relative humidity.

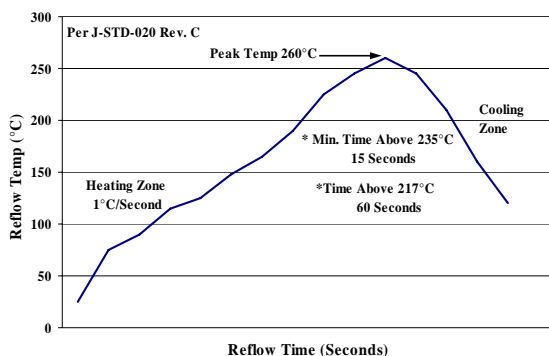

Recommended linear reflow profile using Sn/Ag/Cu solder.



## NON-ISOLATED DC/DC CONVERTERS

4.5 Vdc - 14 Vdc Input, 0.59 Vdc - 5.5 Vdc /6 A Outputs



October 8, 2009

*Bel Power, Inc. , a subsidiary of Bel Fuse, Inc.*

### Post Solder Cleaning and Drying Considerations

Post solder cleaning is usually the final circuit-board assembly process prior to electrical board testing. The result of inadequate cleaning and drying can affect both the reliability of a power module and the testability of the finished circuit-board assembly.

### Revision History

Date	Revision	Changes Detail	Approval
2009-6-1	A	First release	T. Bubriski
2009-6-25	B	Section "Surface Mount Information" added.	T. Bubriski
2009-9-1	C	Tunable Loop™ logo added.	T. Bubriski
2009-10-8	D	Updated Startup Time waveforms on page 10.	T. Bubriski

### RoHS Compliance

Complies with the European Directive 2002/95/EC, calling for the elimination of lead and other hazardous substances from electronic products.



©2009 Bel Fuse Inc. Specifications subject to change without notice. 10/08/09

25

#### CORPORATE

**Bel Fuse Inc.**  
206 Van Vorst Street  
Jersey City, NJ 07302  
Tel 201-432-0463  
Fax 201-432-9542  
[www.belfuse.com](http://www.belfuse.com)

#### FAR EAST

**Bel Fuse Ltd.**  
8F/ 8 Luk Hop Street  
San Po Kong  
Kowloon, Hong Kong  
Tel 852-2328-5515  
Fax 852-2352-3706  
[www.belfuse.com](http://www.belfuse.com)

#### EUROPE

**Bel Fuse Europe Ltd.**  
Preston Technology Management Centre  
Marsh Lane, Suite G7, Preston  
Lancashire, PR1 8UD, U.K.  
Tel 44-1772-556601  
Fax 44-1772-888366  
[www.belfuse.com](http://www.belfuse.com)