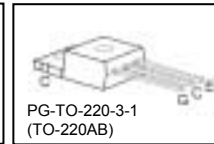
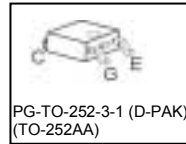
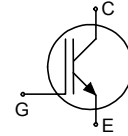


## Fast IGBT in NPT-technology

- 75% lower  $E_{off}$  compared to previous generation combined with low conduction losses
- Short circuit withstand time – 10  $\mu$ s
- Designed for:
  - Motor controls
  - Inverter
- NPT-Technology for 600V applications offers:
  - very tight parameter distribution
  - high ruggedness, temperature stable behaviour
  - parallel switching capability
- Pb-free lead plating; RoHS compliant
- Qualified according to JEDEC<sup>2</sup> for target applications
- Complete product spectrum and PSpice Models : <http://www.infineon.com/igbt/>



Type	$V_{CE}$	$I_C$	$V_{CE(sat)150^\circ C}$	$T_j$	Marking	Package
SGP04N60	600V	4A	2.3V	150°C	G04N60	PG-TO-220-3-1
SGD04N60	600V	4A	2.3V	150°C	G04N60	PG-TO-252-3-11

### Maximum Ratings

Parameter	Symbol	Value	Unit
Collector-emitter voltage	$V_{CE}$	600	V
DC collector current	$I_C$		A
$T_C = 25^\circ C$		9.4	
$T_C = 100^\circ C$		4.9	
Pulsed collector current, $t_p$ limited by $T_{jmax}$	$I_{Cpuls}$	19	
Turn off safe operating area $V_{CE} \leq 600V, T_j \leq 150^\circ C$	-	19	
Gate-emitter voltage	$V_{GE}$	$\pm 20$	V
Avalanche energy, single pulse $I_C = 4 A, V_{CC} = 50 V, R_{GE} = 25 \Omega,$ start at $T_j = 25^\circ C$	$E_{AS}$	25	mJ
Short circuit withstand time <sup>1)</sup> $V_{GE} = 15V, V_{CC} \leq 600V, T_j \leq 150^\circ C$	$t_{SC}$	10	$\mu$ s
Power dissipation $T_C = 25^\circ C$	$P_{tot}$	50	W
Operating junction and storage temperature	$T_j, T_{stg}$	-55...+150	°C
Soldering temperature, PG-TO-252: (reflow soldering, MSL3) Others: wavesoldering, 1.6mm (0.063 in.) from case for 10s	$T_s$	260 260	

<sup>2</sup> J-STD-020 and JESD-022

<sup>1)</sup> Allowed number of short circuits: <1000; time between short circuits: >1s.

**Thermal Resistance**

Parameter	Symbol	Conditions	Max. Value	Unit
<b>Characteristic</b>				
IGBT thermal resistance, junction – case	$R_{thJC}$		2.5	K/W
Thermal resistance, junction – ambient	$R_{thJA}$	PG-TO-220-3-1	62	
SMD version, device on PCB <sup>1)</sup>	$R_{thJA}$	PG-TO-252-3-1	50	

**Electrical Characteristic, at  $T_j = 25^\circ\text{C}$ , unless otherwise specified**

Parameter	Symbol	Conditions	Value			Unit
			min.	Typ.	max.	
<b>Static Characteristic</b>						
Collector-emitter breakdown voltage	$V_{(BR)CES}$	$V_{GE}=0V, I_C=500\mu A$	600	-	-	V
Collector-emitter saturation voltage	$V_{CE(sat)}$	$V_{GE} = 15V, I_C=4A$ $T_j=25^\circ\text{C}$ $T_j=150^\circ\text{C}$	1.7 -	2.0 2.3	2.4 2.8	
Gate-emitter threshold voltage	$V_{GE(th)}$	$I_C=200\mu A, V_{CE}=V_{GE}$	3	4	5	
Zero gate voltage collector current	$I_{CES}$	$V_{CE}=600V, V_{GE}=0V$ $T_j=25^\circ\text{C}$ $T_j=150^\circ\text{C}$	- -	- -	20 500	$\mu A$
Gate-emitter leakage current	$I_{GES}$	$V_{CE}=0V, V_{GE}=20V$	-	-	100	
Transconductance	$g_{fs}$	$V_{CE}=20V, I_C=4A$		3.1	-	S
<b>Dynamic Characteristic</b>						
Input capacitance	$C_{iss}$	$V_{CE}=25V,$ $V_{GE}=0V,$ $f=1\text{MHz}$	-	264	317	pF
Output capacitance	$C_{oss}$		-	29	35	
Reverse transfer capacitance	$C_{riss}$		-	17	20	
Gate charge	$Q_{Gate}$	$V_{CC}=480V, I_C=4A$ $V_{GE}=15V$	-	24	31	nC
Internal emitter inductance measured 5mm (0.197 in.) from case	$L_E$		-	7	-	nH
Short circuit collector current <sup>2)</sup>	$I_{C(SC)}$	$V_{GE}=15V, t_{SC}\leq 10\mu s$ $V_{CC}\leq 600V,$ $T_j\leq 150^\circ\text{C}$	-	40	-	A

<sup>1)</sup> Device on 50mm\*50mm\*1.5mm epoxy PCB FR4 with 6cm<sup>2</sup> (one layer, 70 $\mu$ m thick) copper area for collector connection. PCB is vertical without blown air.

<sup>2)</sup> Allowed number of short circuits: <1000; time between short circuits: >1s.

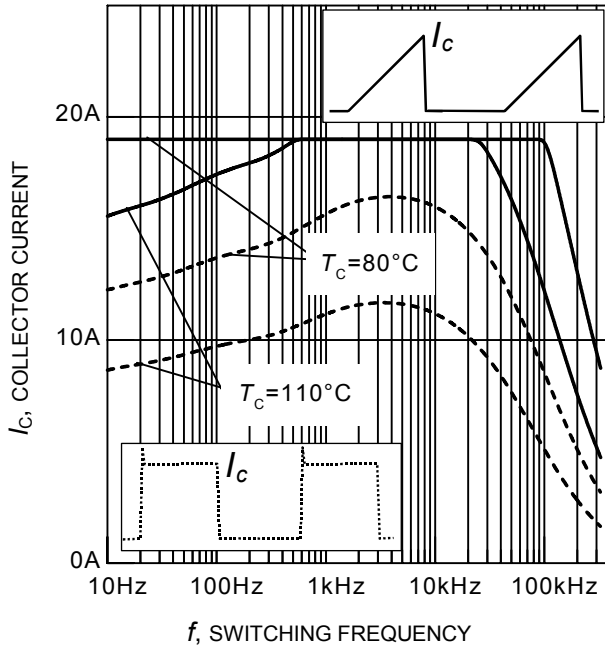
**Switching Characteristic, Inductive Load, at  $T_j=25^\circ\text{C}$**

Parameter	Symbol	Conditions	Value			Unit
			min.	typ.	max.	
<b>IGBT Characteristic</b>						
Turn-on delay time	$t_{d(\text{on})}$	$T_j=25^\circ\text{C}$ , $V_{\text{CC}}=400\text{V}$ , $I_{\text{C}}=4\text{A}$ , $V_{\text{GE}}=0/15\text{V}$ , $R_{\text{G}}=67\Omega$ , $L_{\sigma}^{(1)}=180\text{nH}$ , $C_{\sigma}^{(1)}=180\text{pF}$ Energy losses include "tail" and diode reverse recovery.	-	22	26	ns
Rise time	$t_{\text{r}}$		-	15	18	
Turn-off delay time	$t_{d(\text{off})}$		-	237	284	
Fall time	$t_{\text{f}}$		-	70	84	
Turn-on energy	$E_{\text{on}}$		-	0.070	0.081	mJ
Turn-off energy	$E_{\text{off}}$		-	0.061	0.079	
Total switching energy	$E_{\text{ts}}$		-	0.131	0.160	

**Switching Characteristic, Inductive Load, at  $T_j=150^\circ\text{C}$**

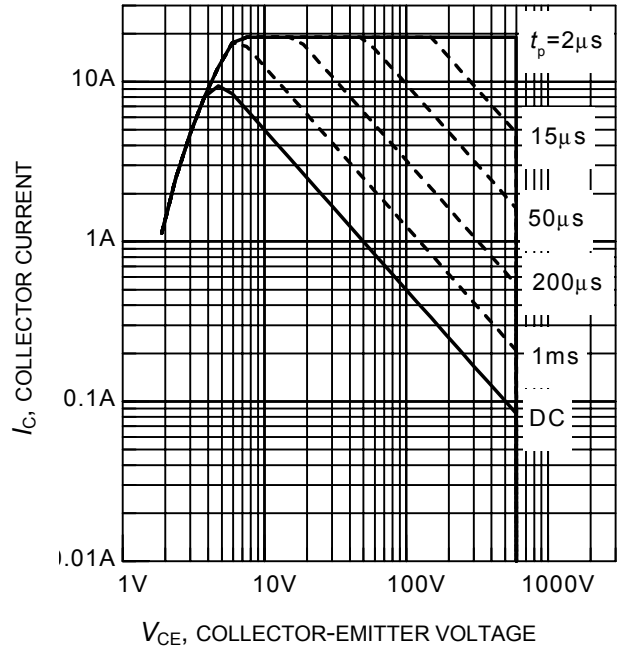
Parameter	Symbol	Conditions	Value			Unit
			min.	typ.	max.	
<b>IGBT Characteristic</b>						
Turn-on delay time	$t_{d(\text{on})}$	$T_j=150^\circ\text{C}$ $V_{\text{CC}}=400\text{V}$ , $I_{\text{C}}=4\text{A}$ , $V_{\text{GE}}=0/15\text{V}$ , $R_{\text{G}}=67\Omega$ , $L_{\sigma}^{(1)}=180\text{nH}$ , $C_{\sigma}^{(1)}=180\text{pF}$ Energy losses include "tail" and diode reverse recovery.	-	22	26	ns
Rise time	$t_{\text{r}}$		-	16	19	
Turn-off delay time	$t_{d(\text{off})}$		-	264	317	
Fall time	$t_{\text{f}}$		-	104	125	
Turn-on energy	$E_{\text{on}}$		-	0.115	0.132	mJ
Turn-off energy	$E_{\text{off}}$		-	0.111	0.144	
Total switching energy	$E_{\text{ts}}$		-	0.226	0.277	

<sup>1)</sup> Leakage inductance  $L_{\sigma}$  and Stray capacity  $C_{\sigma}$  due to dynamic test circuit in Figure E.



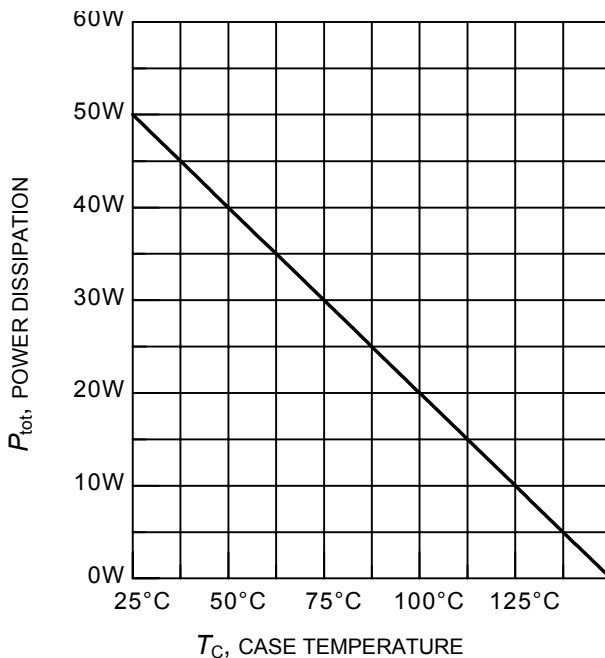
**Figure 1. Collector current as a function of switching frequency**

( $T_j \leq 150^\circ\text{C}$ ,  $D = 0.5$ ,  $V_{CE} = 400\text{V}$ ,  $V_{GE} = 0/+15\text{V}$ ,  $R_G = 67\Omega$ )



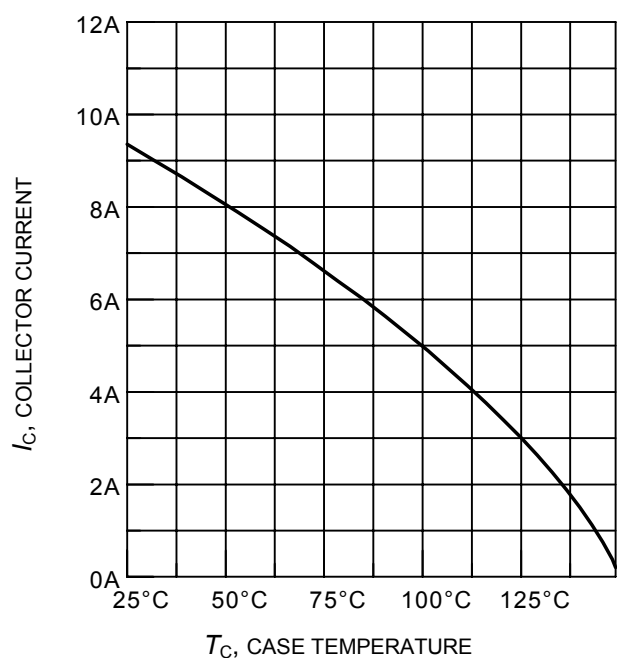
**Figure 2. Safe operating area**

( $D = 0$ ,  $T_C = 25^\circ\text{C}$ ,  $T_j \leq 150^\circ\text{C}$ )



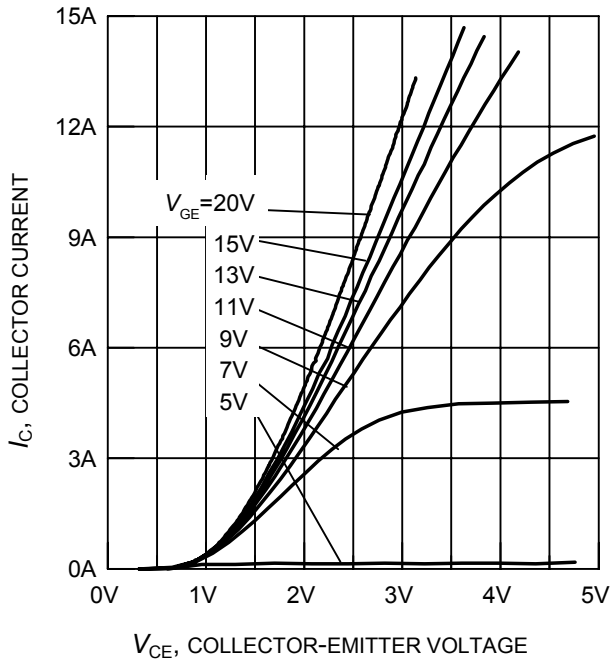
**Figure 3. Power dissipation as a function of case temperature**

( $T_j \leq 150^\circ\text{C}$ )

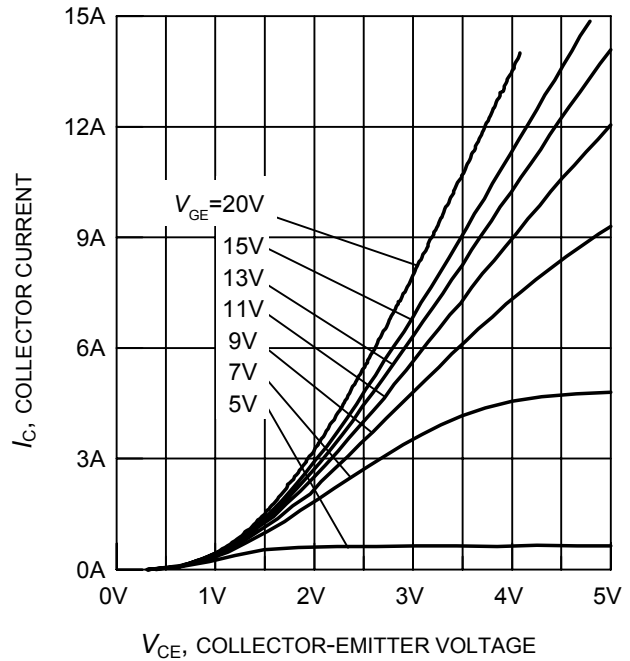


**Figure 4. Collector current as a function of case temperature**

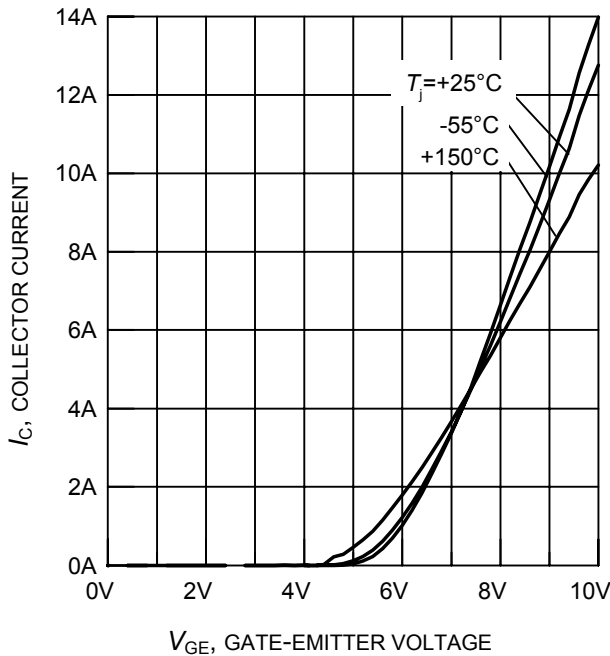
( $V_{GE} \leq 15\text{V}$ ,  $T_j \leq 150^\circ\text{C}$ )



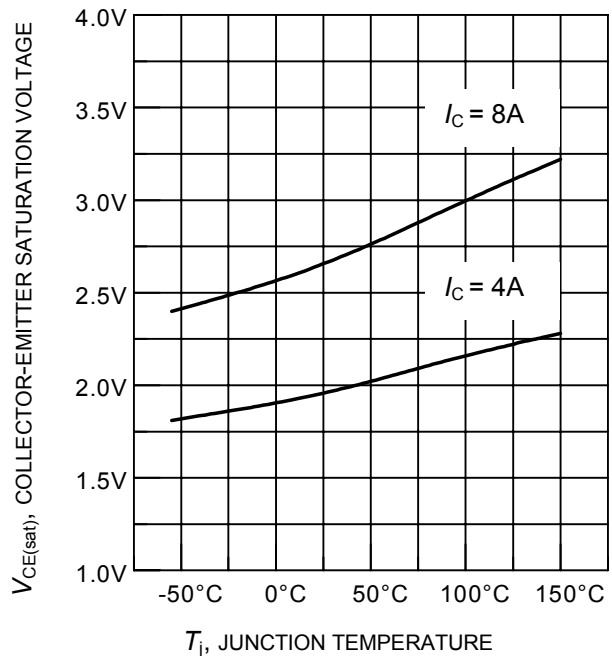
**Figure 5. Typical output characteristics**  
( $T_j = 25^\circ\text{C}$ )



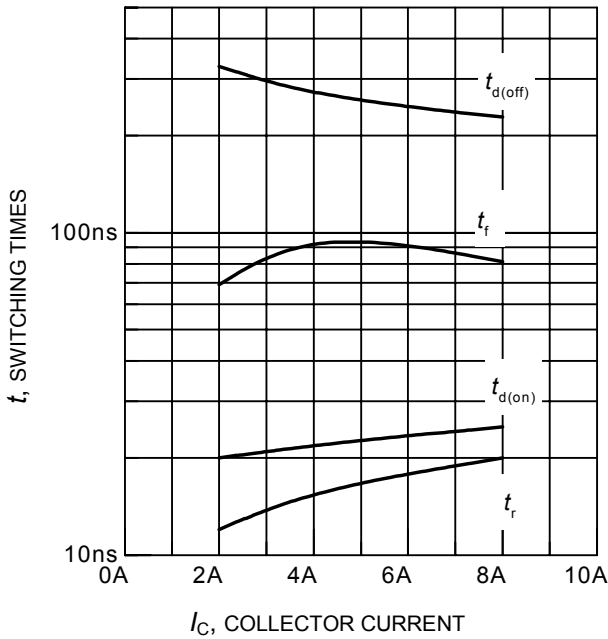
**Figure 6. Typical output characteristics**  
( $T_j = 150^\circ\text{C}$ )



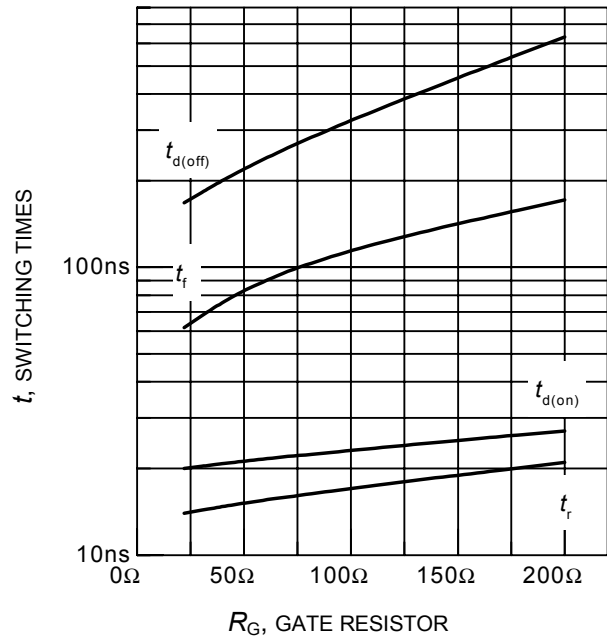
**Figure 7. Typical transfer characteristics**  
( $V_{CE} = 10\text{V}$ )



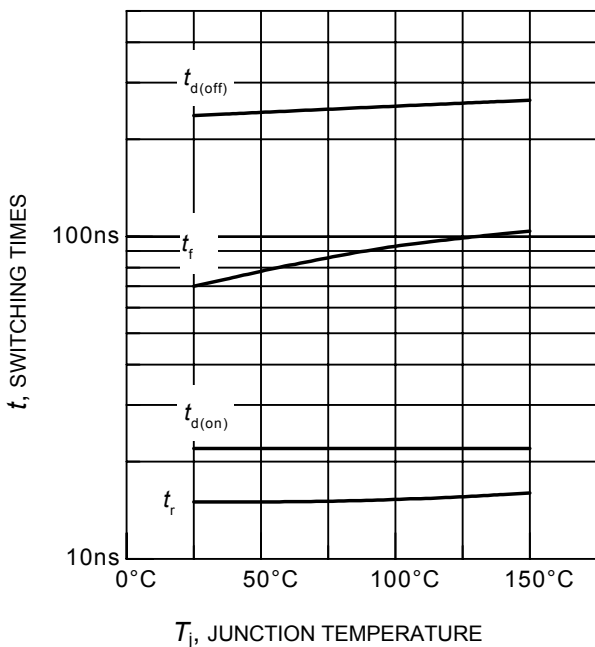
**Figure 8. Typical collector-emitter saturation voltage as a function of junction temperature**  
( $V_{GE} = 15\text{V}$ )



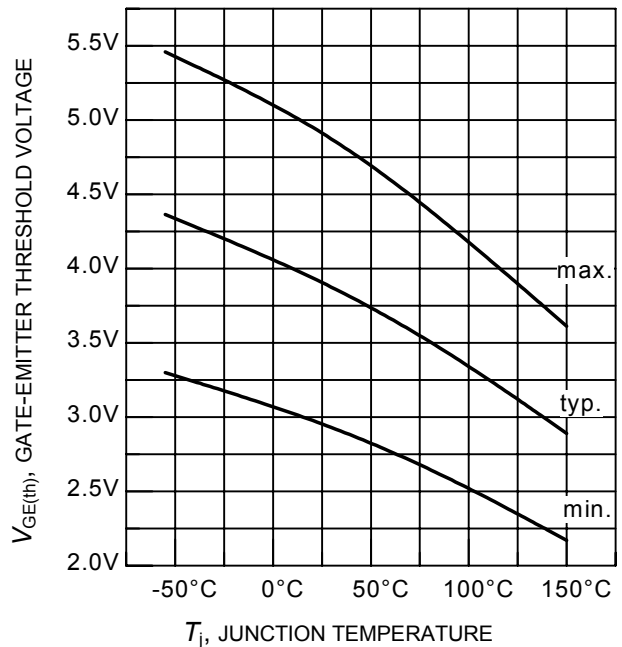
**Figure 9. Typical switching times as a function of collector current**  
(inductive load,  $T_j = 150^\circ\text{C}$ ,  $V_{CE} = 400\text{V}$ ,  $V_{GE} = 0/+15\text{V}$ ,  $R_G = 67\Omega$ ,  
Dynamic test circuit in Figure E)



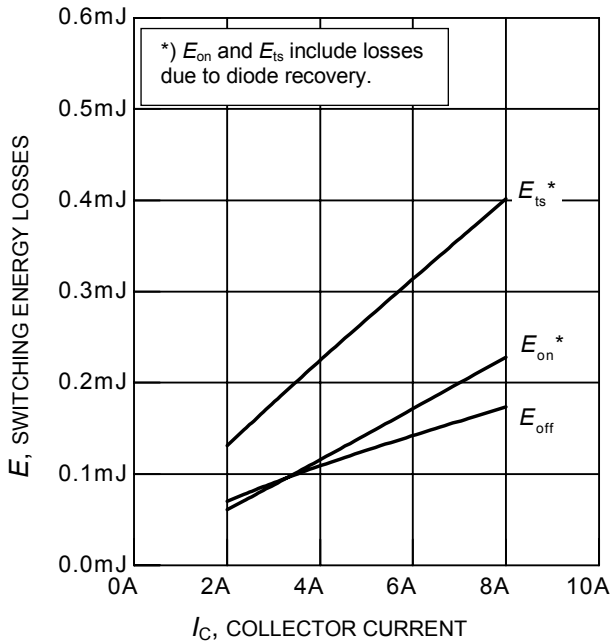
**Figure 10. Typical switching times as a function of gate resistor**  
(inductive load,  $T_j = 150^\circ\text{C}$ ,  $V_{CE} = 400\text{V}$ ,  $V_{GE} = 0/+15\text{V}$ ,  $I_C = 4\text{A}$ ,  
Dynamic test circuit in Figure E)



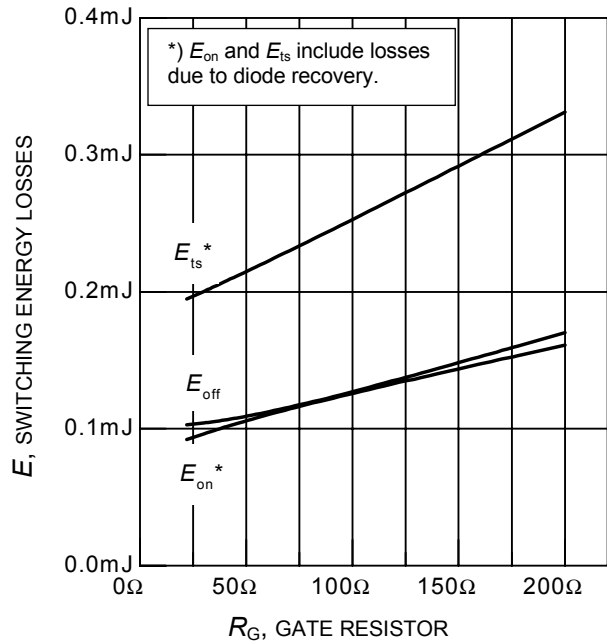
**Figure 11. Typical switching times as a function of junction temperature**  
(inductive load,  $V_{CE} = 400\text{V}$ ,  $V_{GE} = 0/+15\text{V}$ ,  $I_C = 4\text{A}$ ,  $R_G = 67\Omega$ ,  
Dynamic test circuit in Figure E)



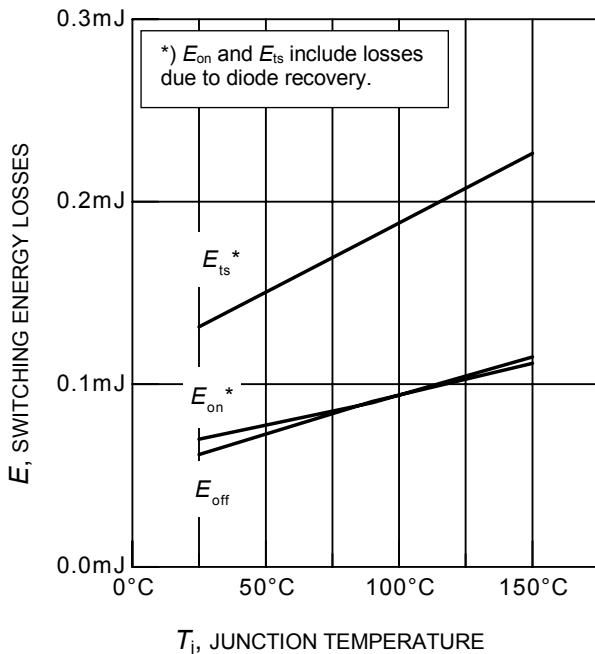
**Figure 12. Gate-emitter threshold voltage as a function of junction temperature**  
( $I_C = 0.2\text{mA}$ )



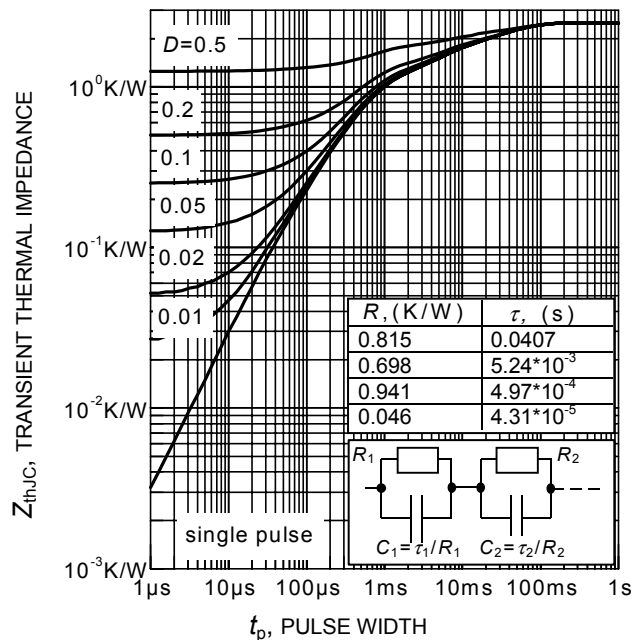
**Figure 13. Typical switching energy losses as a function of collector current**  
(inductive load,  $T_j = 150^\circ\text{C}$ ,  $V_{CE} = 400\text{V}$ ,  $V_{GE} = 0/+15\text{V}$ ,  $R_G = 67\Omega$ , Dynamic test circuit in Figure E)



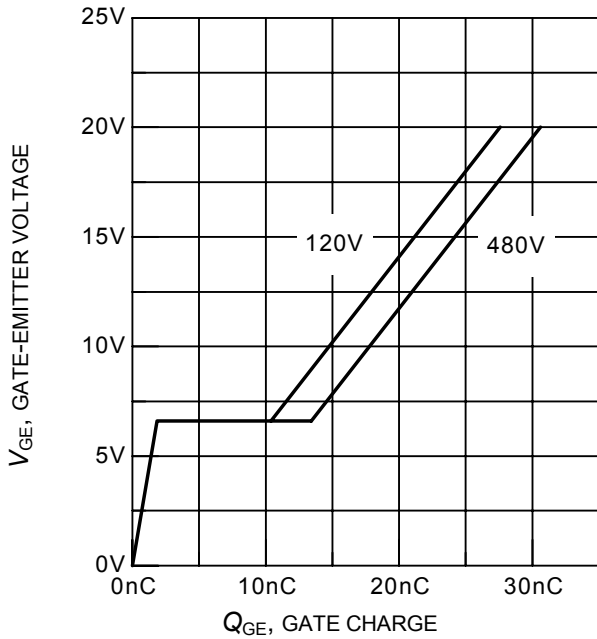
**Figure 14. Typical switching energy losses as a function of gate resistor**  
(inductive load,  $T_j = 150^\circ\text{C}$ ,  $V_{CE} = 400\text{V}$ ,  $V_{GE} = 0/+15\text{V}$ ,  $I_C = 4\text{A}$ , Dynamic test circuit in Figure E)



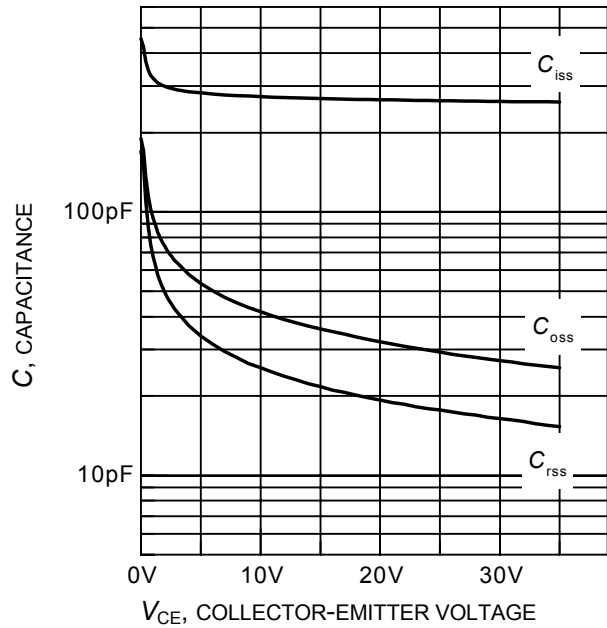
**Figure 15. Typical switching energy losses as a function of junction temperature**  
(inductive load,  $V_{CE} = 400\text{V}$ ,  $V_{GE} = 0/+15\text{V}$ ,  $I_C = 4\text{A}$ ,  $R_G = 67\Omega$ , Dynamic test circuit in Figure E)



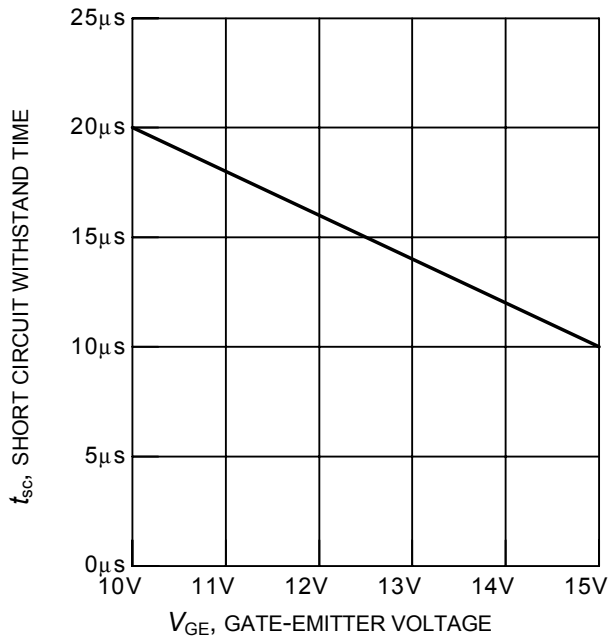
**Figure 16. IGBT transient thermal impedance as a function of pulse width**  
( $D = t_p / T$ )



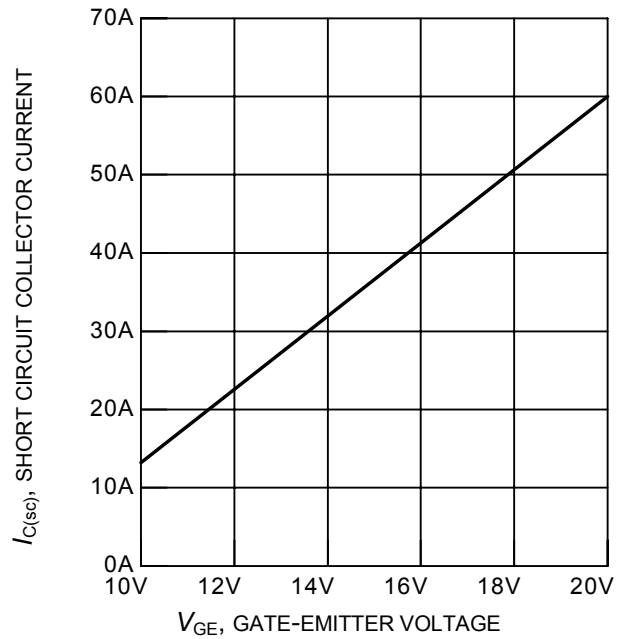
**Figure 17. Typical gate charge**  
( $I_C = 4A$ )



**Figure 18. Typical capacitance as a function of collector-emitter voltage**  
( $V_{GE} = 0V, f = 1MHz$ )



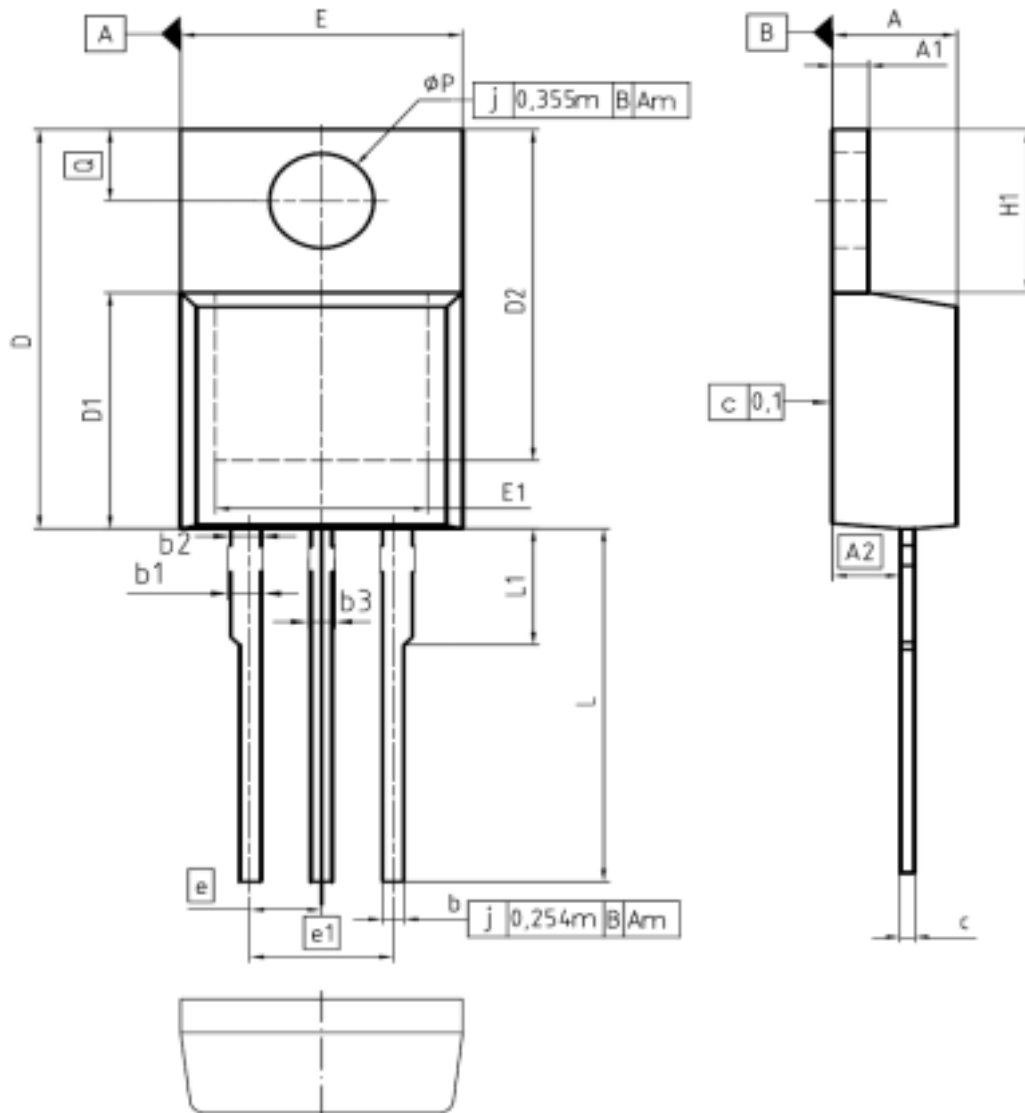
**Figure 19. Short circuit withstand time as a function of gate-emitter voltage**  
( $V_{CE} = 600V, \text{start at } T_j = 25^\circ C$ )



**Figure 20. Typical short circuit collector current as a function of gate-emitter voltage**  
( $V_{CE} \leq 600V, T_j = 150^\circ C$ )



PG-TO-220-3-1



DIM	MILLIMETERS		INCHES	
	MIN	MAX	MIN	MAX
A	4.30	4.57	0.169	0.180
A1	1.17	1.40	0.046	0.055
A2	2.15	2.72	0.085	0.107
b	0.65	0.86	0.026	0.034
b1	0.95	1.40	0.037	0.055
b2	0.95	1.15	0.037	0.045
b3	0.65	1.15	0.026	0.045
c	0.33	0.60	0.013	0.024
D	14.81	15.95	0.583	0.628
D1	8.51	9.45	0.335	0.372
D2	12.19	13.10	0.480	0.516
E	9.70	10.36	0.382	0.408
E1	6.50	8.60	0.256	0.339
e	2.54		0.100	
e1	5.08		0.200	
N	3		3	
H1	5.90	6.90	0.232	0.272
L	13.00	14.00	0.512	0.551
L1	-	4.80	-	0.189
aP	3.60	3.89	0.142	0.153
Q	2.60	3.00	0.102	0.118

DOCUMENT NO.  
Z880003318

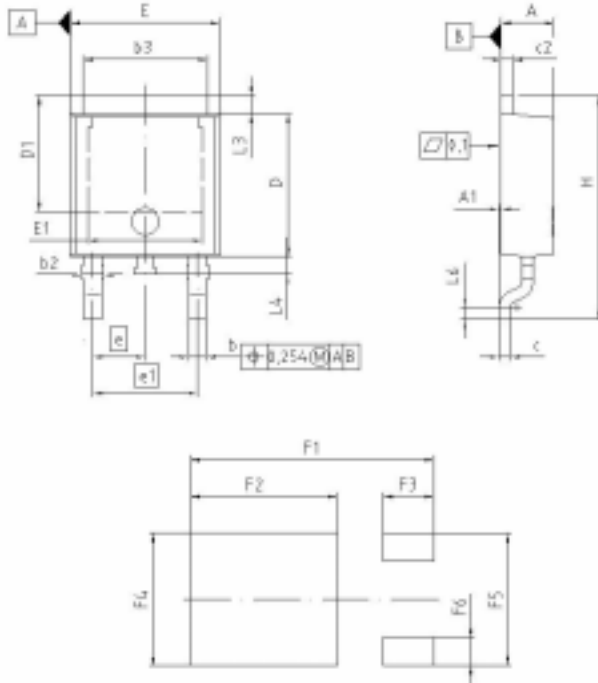
SCALE 0 2.5 5mm

EUROPEAN PROJECTION

ISSUE DATE  
23-08-2007

REVISION  
05

P-TO252-3-11



DIM	MILLIMETERS		INCHES	
	MIN	MAX	MIN	MAX
A	2.894	2.388	0.086	0.094
A1	0.000	0.150	0.000	0.006
b	0.835	0.880	0.025	0.035
b2	0.650	1.450	0.025	0.045
b3	5.004	5.500	0.197	0.217
e	0.400	0.580	0.016	0.023
c2	0.400	0.960	0.016	0.039
D	5.959	6.221	0.235	0.245
D1	5.020	5.320	0.198	0.209
E	6.400	6.721	0.252	0.265
E1	4.900	5.100	0.193	0.201
e	2.286		0.090	
e1	4.572		0.180	
N	S		S	
H	0.400	10.094	0.016	0.397
L3	0.900	1.118	0.035	0.044
L4	0.650	1.018	0.026	0.040
L6	0.540	0.666	0.021	0.027
F1	10.500	10.700	0.413	0.421
F2	6.300	6.500	0.248	0.256
F3	2.800	2.300	0.083	0.091
F4	5.700	5.900	0.224	0.232
F5	5.880	5.880	0.232	0.231
F6	1.100	1.300	0.043	0.051

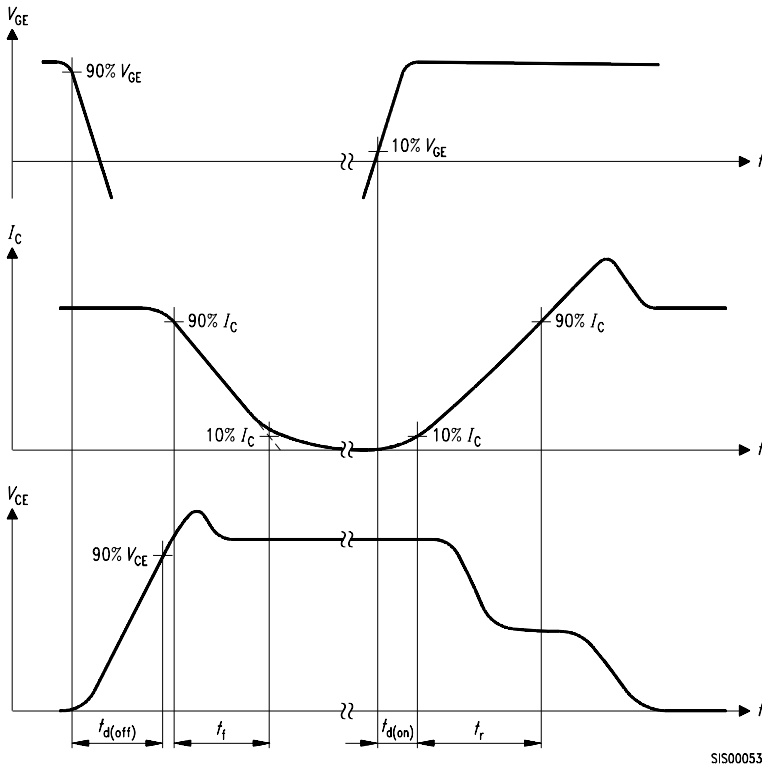


Figure A. Definition of switching times

SIS00053

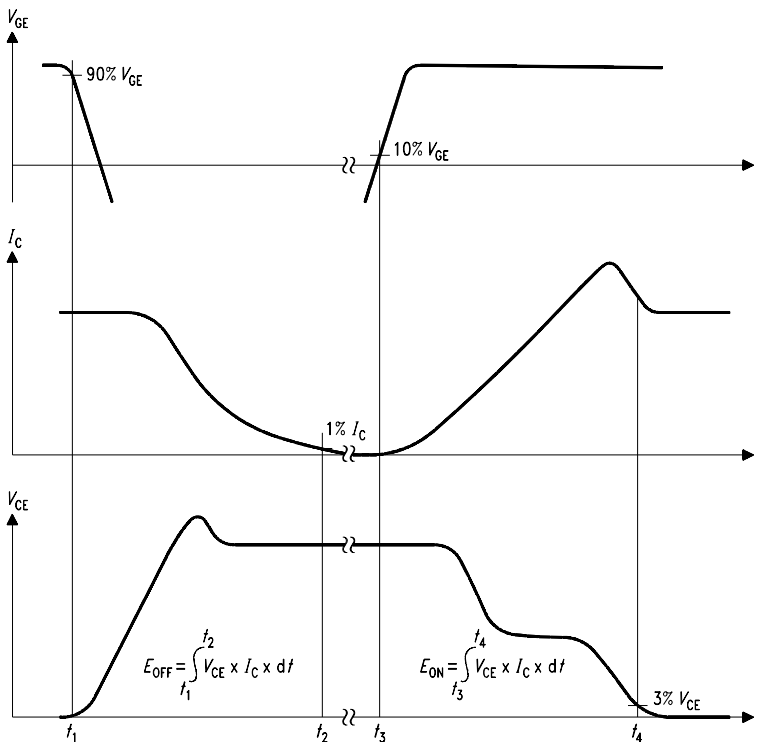


Figure B. Definition of switching losses

SIS00050

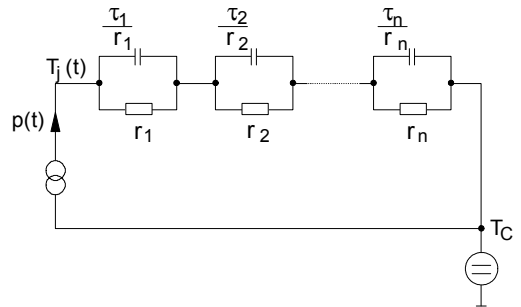


Figure D. Thermal equivalent circuit

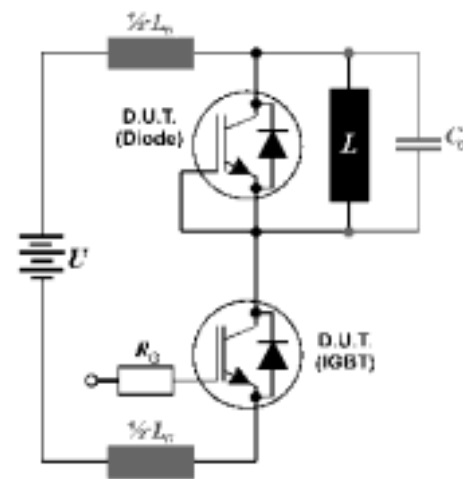


Figure E. Dynamic test circuit  
Leakage inductance  $L_{\sigma} = 180\text{nH}$   
and Stray capacity  $C_{\sigma} = 180\text{pF}$ .

**Edition 2006-01**

**Published by  
Infineon Technologies AG  
81726 München, Germany**

**© Infineon Technologies AG 9/12/07.  
All Rights Reserved.**

**Attention please!**

The information given in this data sheet shall in no event be regarded as a guarantee of conditions or characteristics ("Beschaffenhheitsgarantie"). With respect to any examples or hints given herein, any typical values stated herein and/or any information regarding the application of the device, Infineon Technologies hereby disclaims any and all warranties and liabilities of any kind, including without limitation warranties of non-infringement of intellectual property rights of any third party.

**Information**

For further information on technology, delivery terms and conditions and prices please contact your nearest Infineon Technologies Office ([www.infineon.com](http://www.infineon.com)).

**Warnings**

Due to technical requirements components may contain dangerous substances. For information on the types in question please contact your nearest Infineon Technologies Office.

Infineon Technologies Components may only be used in life-support devices or systems with the express written approval of Infineon Technologies, if a failure of such components can reasonably be expected to cause the failure of that life-support device or system, or to affect the safety or effectiveness of that device or system. Life support devices or systems are intended to be implanted in the human body, or to support and/or maintain and sustain and/or protect human life. If they fail, it is reasonable to assume that the health of the user or other persons may be endangered.