

**POWER MOSFET  
 THRU-HOLE (TO-257AA)**

**IRFY044C,IRFY044CM  
 60V, N-CHANNEL  
 HEXFET® MOSFET TECHNOLOGY**

**Product Summary**

Part Number	R <sub>DS(on)</sub>	I <sub>D</sub>	Eyelets
IRFY044C	0.040 Ω	16*A	Ceramic
IRFY044CM	0.040 Ω	16*A	Ceramic

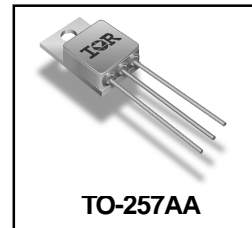

**TO-257AA**

HEXFET® MOSFET technology is the key to International Rectifier's advanced line of power MOSFET transistors. The efficient geometry design achieves very low on-state resistance combined with high transconductance. HEXFET transistors also feature all of the well-established advantages of MOSFETs, such as voltage control, very fast switching, ease of paralleling and electrical parameter temperature stability. They are well-suited for applications such as switching power supplies, motor controls, inverters, choppers, audio amplifiers, high energy pulse circuits, and virtually any application where high reliability is required. The HEXFET transistor's totally isolated package eliminates the need for additional isolating material between the device and the heatsink. This improves thermal efficiency and reduces drain capacitance.

**Features:**

- Simple Drive Requirements
- Ease of Paralleling
- Hermetically Sealed
- Electrically Isolated
- Ceramic Eyelets
- Ideally Suited For Space Level Applications

**Absolute Maximum Ratings**

	Parameter		Units
I <sub>D</sub> @ V <sub>GS</sub> = 10V, T <sub>C</sub> = 25°C	Continuous Drain Current	16*	A
I <sub>D</sub> @ V <sub>GS</sub> = 10V, T <sub>C</sub> = 100°C	Continuous Drain Current	16*	
I <sub>DM</sub>	Pulsed Drain Current ①	156	
P <sub>D</sub> @ T <sub>C</sub> = 25°C	Max. Power Dissipation	100	W
	Linear Derating Factor	0.8	W/°C
V <sub>GS</sub>	Gate-to-Source Voltage	±20	V
E <sub>AS</sub>	Single Pulse Avalanche Energy ②	100	mJ
I <sub>AR</sub>	Avalanche Current ①	16*	A
E <sub>AR</sub>	Repetitive Avalanche Energy ①	10	mJ
dv/dt	Peak Diode Recovery dv/dt ③	4.5	V/ns
T <sub>J</sub>	Operating Junction	-55 to 150	°C
T <sub>STG</sub>	Storage Temperature Range		
	Lead Temperature	300(0.063in./1.6mm from case for 10 sec)	
	Weight	4.3 (Typical)	g

\* Current is limited by pin diameter  
 For footnotes refer to the last page

**Electrical Characteristics @ Tj = 25°C (Unless Otherwise Specified)**

	Parameter	Min	Typ	Max	Units	Test Conditions
BVDSS	Drain-to-Source Breakdown Voltage	60	—	—	V	VGS = 0V, ID = 1.0mA
ΔBVDSS/ΔTj	Temperature Coefficient of Breakdown Voltage	—	0.68	—	V/°C	Reference to 25°C, ID = 1.0mA
RDS(on)	Static Drain-to-Source On-State Resistance	—	—	0.04	Ω	VGS = 10V, ID = 16A ④
VGS(th)	Gate Threshold Voltage	2.0	—	4.0	V	VDS = VGS, ID = 250μA
gfs	Forward Transconductance	17	—	—	S (r)	VDS > 15V, IDS = 16A ④
IDSS	Zero Gate Voltage Drain Current	—	—	25	μA	VDS = 48V, VGS = 0V
		—	—	250		VDS = 48V, VGS = 0V, Tj = 125°C
IGSS	Gate-to-Source Leakage Forward	—	—	100	nA	VGS = 20V
IGSS	Gate-to-Source Leakage Reverse	—	—	-100		VGS = -20V
Qg	Total Gate Charge	—	—	88	nC	VGS = 10V, ID = 16A VDS = 30V
Qgs	Gate-to-Source Charge	—	—	15		
Qgd	Gate-to-Drain ('Miller') Charge	—	—	52		
td(on)	Turn-On Delay Time	—	—	23	ns	VDD = 30V, ID = 16A, RG = 9.1Ω
tr	Rise Time	—	—	130		
td(off)	Turn-Off Delay Time	—	—	81		
tf	Fall Time	—	—	79		
LS + LD	Total Inductance	—	6.8	—	nH	Measured from drain lead (6mm/0.25in. from package) to source lead (6mm/0.25in. from package)
Ciss	Input Capacitance	—	2400	—	pF	VGS = 0V, VDS = 25V f = 1.0MHz
Coss	Output Capacitance	—	1100	—		
Crss	Reverse Transfer Capacitance	—	230	—		

**Source-Drain Diode Ratings and Characteristics**

	Parameter	Min	Typ	Max	Units	Test Conditions
IS	Continuous Source Current (Body Diode)	—	—	16*	A	
ISM	Pulse Source Current (Body Diode) ①	—	—	156		
VSD	Diode Forward Voltage	—	—	2.5	V	Tj = 25°C, IS = 16A, VGS = 0V ④
trr	Reverse Recovery Time	—	—	220	nS	Tj = 25°C, IF = 16A, di/dt ≤ 100A/μs VDD ≤ 50V ④
QRR	Reverse Recovery Charge	—	—	1.6	μC	
ton	Forward Turn-On Time	Intrinsic turn-on time is negligible. Turn-on speed is substantially controlled by LS + LD.				

\* Current is limited by pin diameter

**Thermal Resistance**

	Parameter	Min	Typ	Max	Units	Test Conditions
RthJC	Junction-to-Case	—	—	1.25	°C/W	
RthCS	Case-to-sink	—	0.21	—		
RthJA	Junction-to-Ambient	—	—	80		Typical socket mount

**Note: Corresponding Spice and Saber models are available on the G&S Website.**

For footnotes refer to the last page

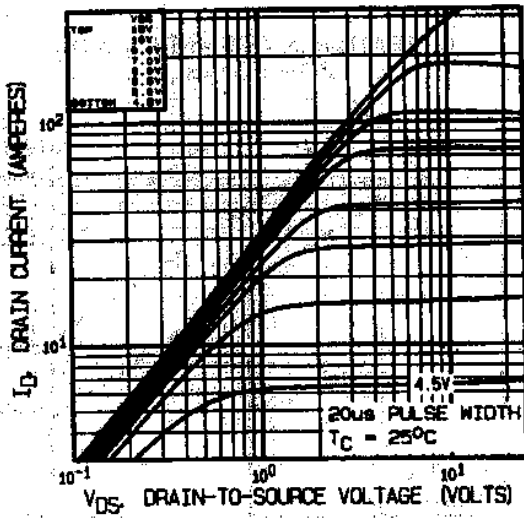

Fig 1. Typical Output Characteristics

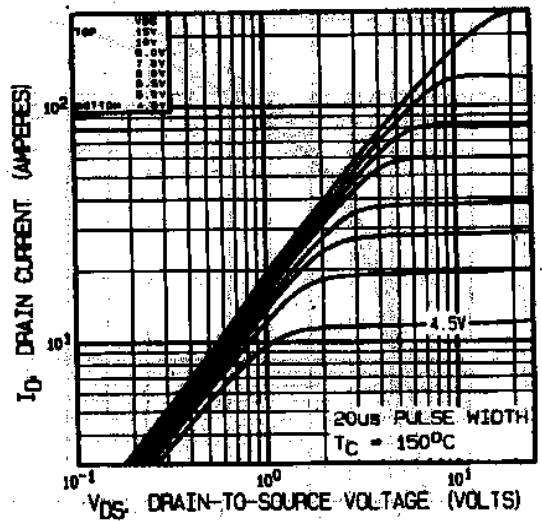

Fig 2. Typical Output Characteristics

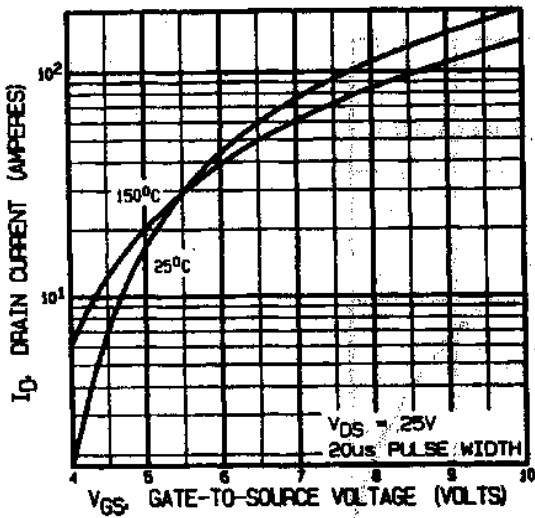

Fig 3. Typical Transfer Characteristics

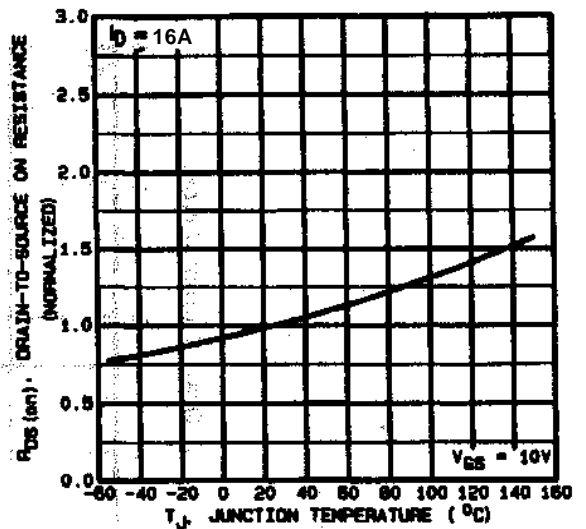

Fig 4. Normalized On-Resistance Vs. Temperature

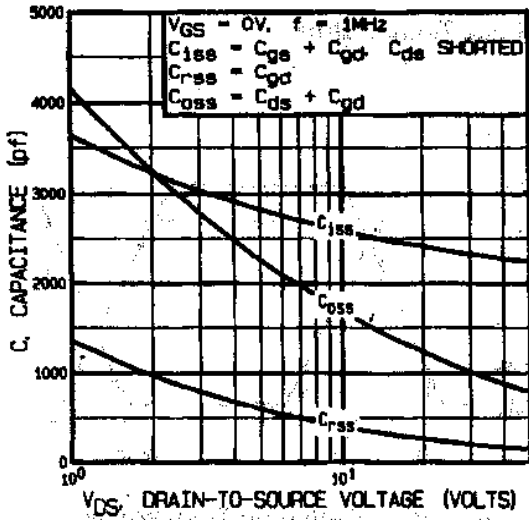

Fig 5. Typical Capacitance Vs. Drain-to-Source Voltage

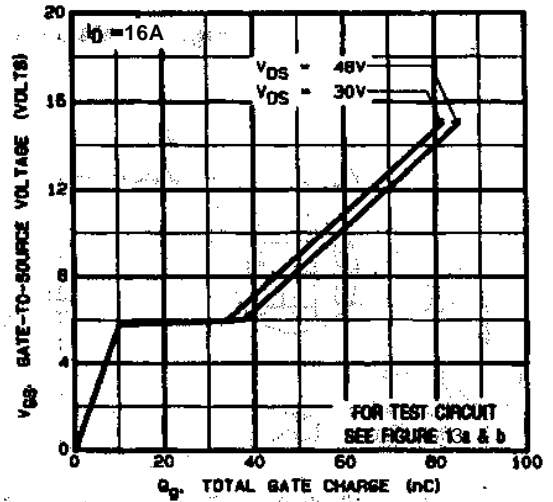

Fig 6. Typical Gate Charge Vs. Gate-to-Source Voltage

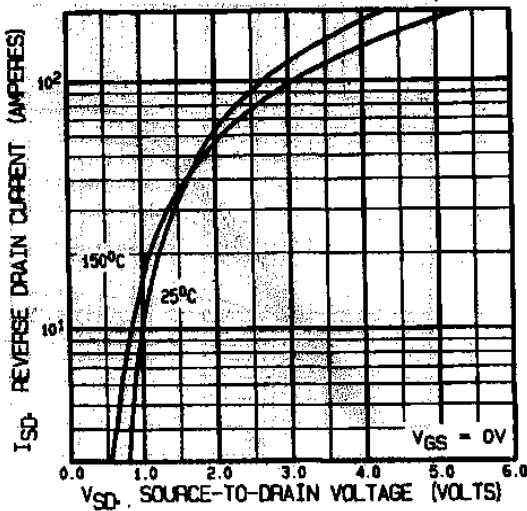

Fig 7. Typical Source-Drain Diode Forward Voltage

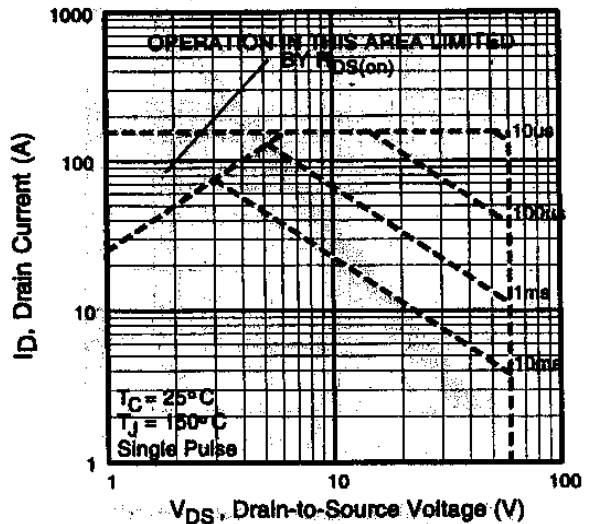

Fig 8. Maximum Safe Operating Area

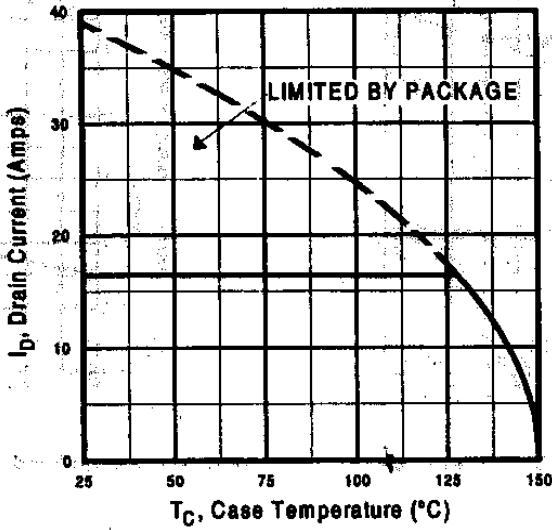

Fig 9. Maximum Drain Current Vs. Case Temperature

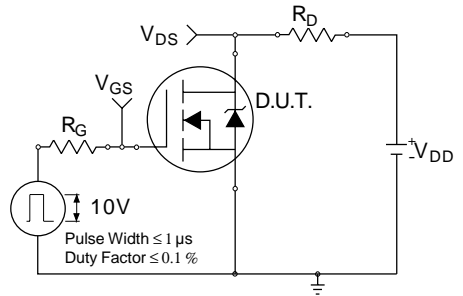

Fig 10a. Switching Time Test Circuit

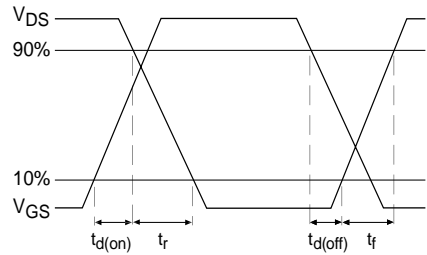

Fig 10b. Switching Time Waveforms

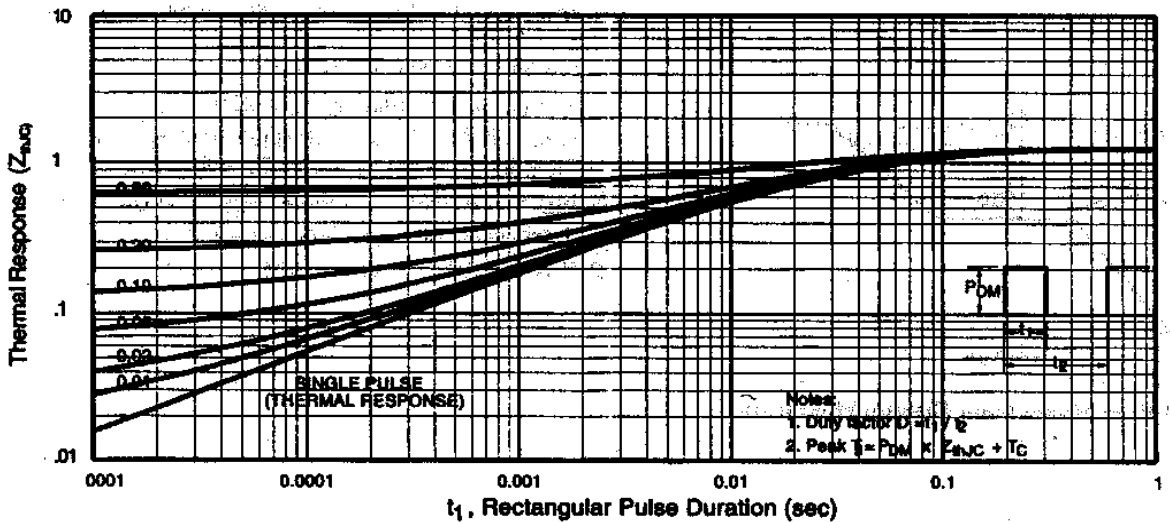

Fig 11. Maximum Effective Transient Thermal Impedance, Junction-to-Case

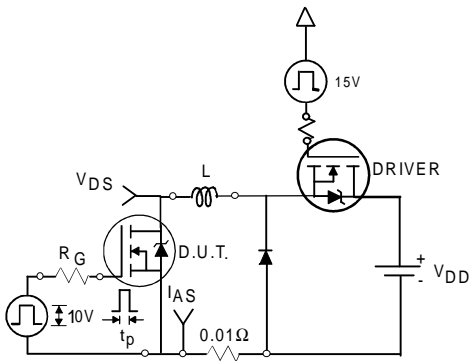

Fig 12a. Unclamped Inductive Test Circuit

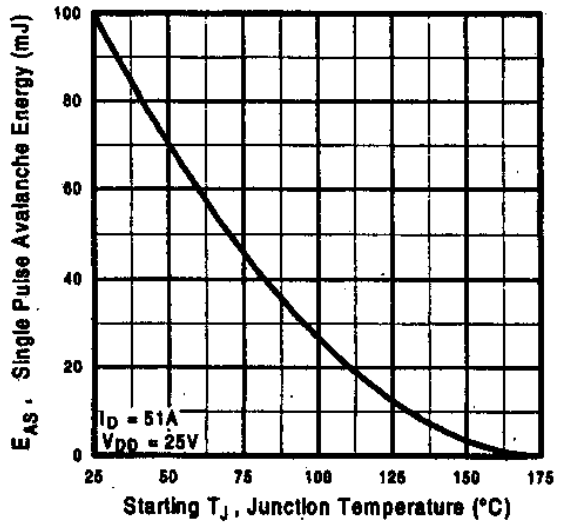

Fig 12c. Maximum Avalanche Energy Vs. Drain Current

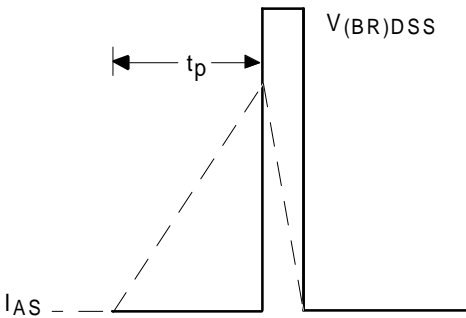

Fig 12b. Unclamped Inductive Waveforms

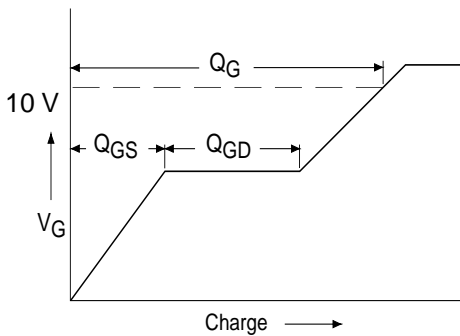

Fig 13a. Basic Gate Charge Waveform

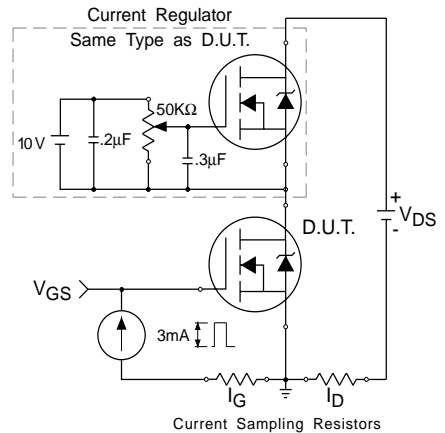
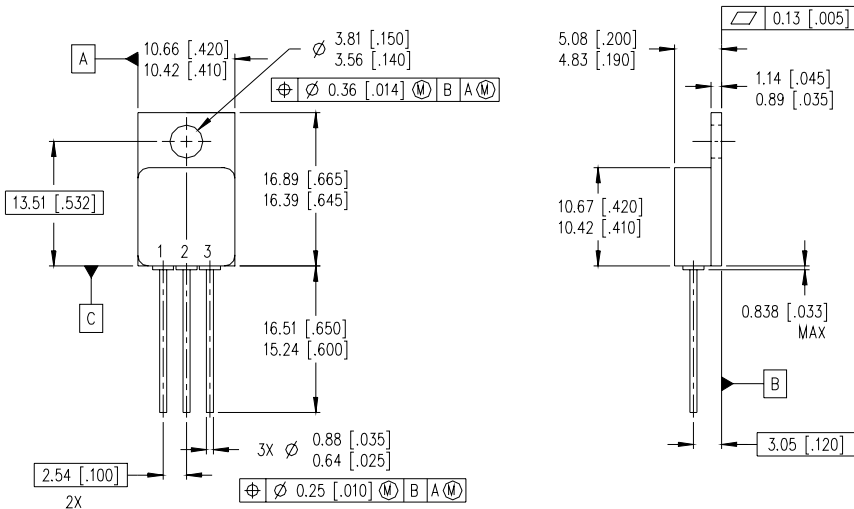

Fig 13b. Gate Charge Test Circuit

**Foot Notes:**

- ① Repetitive Rating; Pulse width limited by maximum junction temperature.
- ②  $V_{DD} = 25V$ , starting  $T_J = 25^\circ C$ ,  $L = 0.78mH$   
 Peak  $I_L = 16A$ ,  $V_{GS} = 10V$
- ③  $I_{SD} \leq 16A$ ,  $di/dt \leq 100A/\mu s$ ,  
 $V_{DD} \leq 60V$ ,  $T_J \leq 150^\circ C$
- ④ Pulse width  $\leq 300 \mu s$ ; Duty Cycle  $\leq 2\%$

**Case Outline and Dimensions — TO-257AA**



**NOTES:**

1. DIMENSIONING & TOLERANCING PER ANSI Y14.5M-1994.
2. CONTROLLING DIMENSION: INCH.
3. DIMENSIONS ARE SHOWN IN MILLIMETERS [INCHES].
4. OUTLINE CONFORMS TO JEDEC OUTLINE TO-257AA.

**LEGEND**

- D - DRAIN
- S - SOURCE
- G - GATE

