



# PRODUCT SPECIFICATION

**Model No : CSM-88131G/88141G**

Descriptions:
<ul style="list-style-type: none"> <li>• 1.5 Inch 8X8 Dot-Matrix Display</li> <li>• Dot Pitch 5.0mm</li> <li>• CSM-88131: Column Anode, Row Cathode</li> <li>• CSM-88141: Column Cathode, Row Anode</li> <li>• Emitting Color: Yellow Green</li> </ul>



CUSTOMER APPROVED	APPROVED BY	CHECKED BY	PREPARED BY
SIGNATURES			

**CHINA SEMICONDUCTOR CORPORATION**  
Address:2FL. NO.909,Chung-Cheng Road,  
Chung-Ho City Taipei Hsien,Taiwan.

**OPTO PLUS TECHNOLOGIES CO.,LTD**  
Address:696 Shun jiang Rd.,Ji Shan St.Shaoxing,  
ZheJiang,China

Tel:886-2-2223-9696  
Fax:886-2-2223-9377

Tel:86-0575-88623888  
Fax:86-0575-88623112



<b>Spec. No.</b>	PS-ND-08090301
<b>Rev.</b>	A

**Model No : CSM-88131G/88141G**

**Features -**

1. 1.5 inch (38.8mm) Matrix height.
2. Case mold type.
3. RoHS compliant.
4. Low power consumption.
5. Easy mounting on P.C. board or socket.

**Device Selection Guide -**

Part No.	Chip		Column	Row
	Material	Emitted Color		
<b>CSM-88131G</b>	<b>GaP</b>	<b>Yellow Green</b>	<b>Anode</b>	<b>Cathode</b>
<b>CSM-88141G</b>	<b>GaP</b>	<b>Yellow Green</b>	<b>Cathode</b>	<b>Anode</b>

**Package Dimensions -**

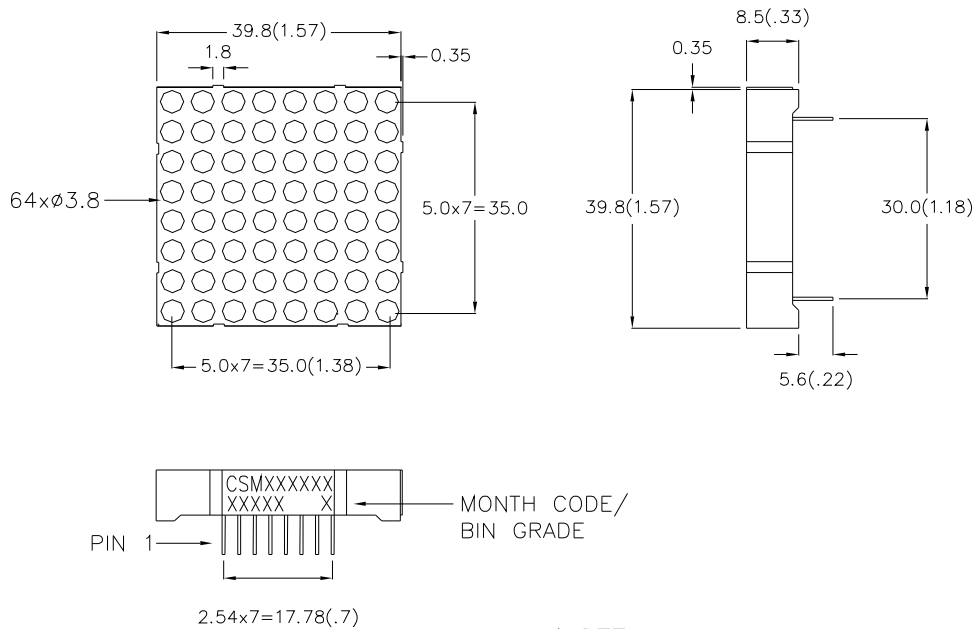

**NOTE:**

1. All pins are  $\phi 0.5(.02)$ .
2. Dimensions in millimeters (inch), tolerance is  $\pm 0.25 (.01)$  unless otherwise noted.



Model No : CSM-88131G/88141G

Internal Circuit Diagrams -

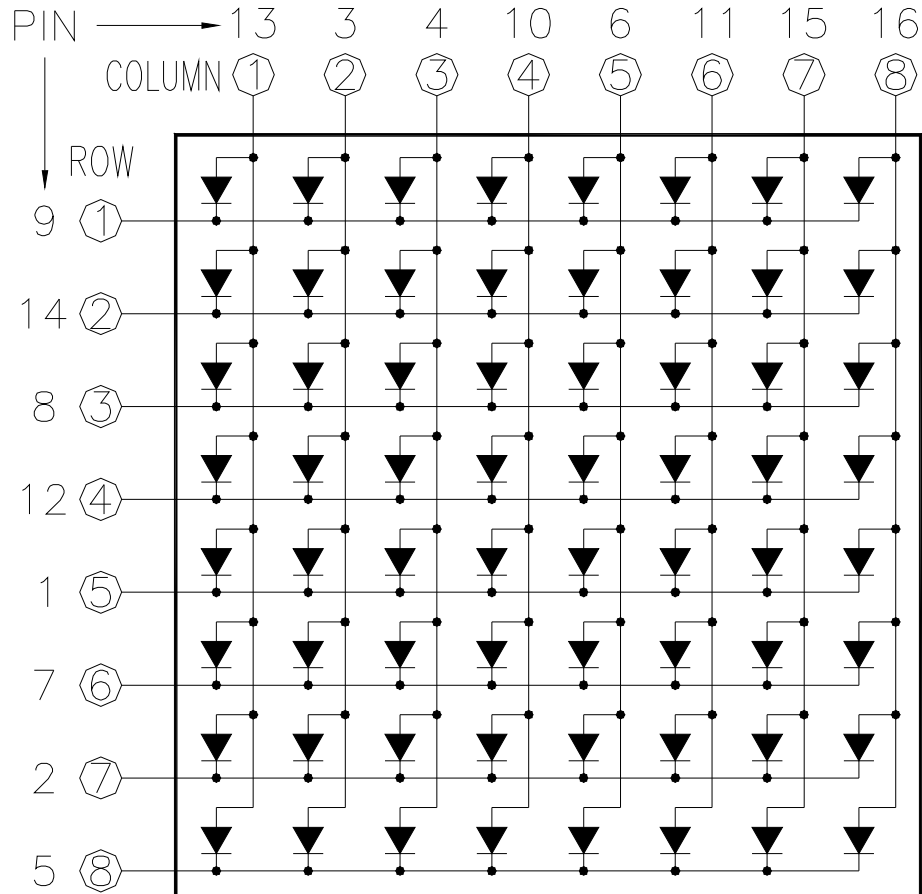

CSM-88131 Column Anode, Row Cathode  
(CSM-88141 Column Cathode, Row Anode)



Model No : CSM-88131G/88141G

■ Absolute Maximum Rating -

(Ta=25°C)

Parameter	Symbol	Rating	Unit
Power Dissipation Per Dice	PAD	70	mW
Continuous Forward Current Per Dice	IAF	25	mA
Peak Current Per Dice(duty cycle 1/10,1KHz)	IPF	90	mA
Derating Linear From 25°C Per Dice	-	0.33	mA/°C
Reverse Voltage Per Dice	VR	5	V
Operating Temp.	Topr	-35 ~ +85	°C
Storage Temp.	Tstg	-35 ~ +85	°C
Solder temperature 1/16 inch below seating plane for 3 seconds at 260°C			

■ Electro-optical Characteristics -

(Ta=25°C)

Parameter	Symbol	Min.	Typ.	Max.	Unit	Condition
Forward Voltage Per Dot	VF	-	2.1	2.8	V	IF=20mA
Luminous Intensity Per Dot	Iv	-	6	-	mcd	IF=10mA
Peak Emission Wavelength	$\lambda_p$	-	568	-	nm	IF=20mA
Dominant Wavelength	$\lambda_d$	-	572	-	nm	IF=20mA
Spectrum Radiation Bandwidth	$\Delta \lambda$	-	30	-	nm	IF=20mA
Reverse Current	IR	-	-	100	$\mu A$	VR=5V
Luminous Intensity Matching Ratio	IV-m	-	-	2:1	-	Ip=80mA 1/16Duty



Model No : CSM-88131G/88141G

■ Typical Electrical / Optical Characteristics Curves -

(Ta = 25°C Unless Otherwise Noted)

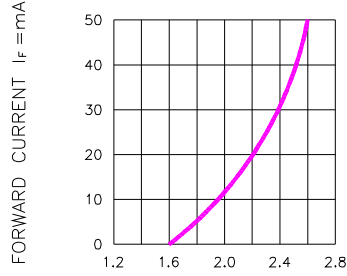

Fig.1 FORWARD CURRENT VS. FORWARD VOLTAGE

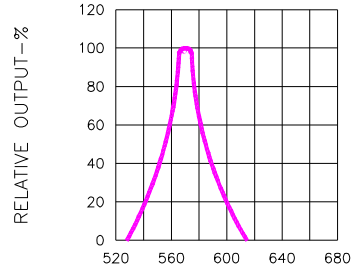

Fig.2 SPECTRAL RESPONSE

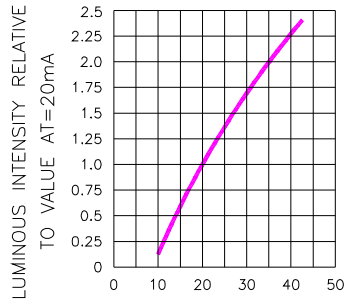

Fig.3 RELATIVE LUMINOUS INTENSITY VS. FORWARD CURRENT

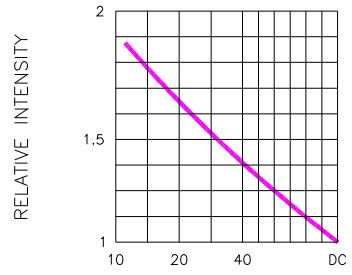

Fig.5 LUMINOUS INTENSITY VS. DUTY CYCLE (AVERAGE I<sub>F</sub> = 10mA)

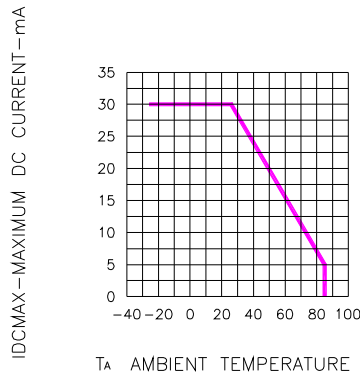

Fig.4 MAXIMUM ALLOWABLE DC CURRENT PER SEGMENT VS. A FUNCTION OF AMBIENT TEMPERATURE

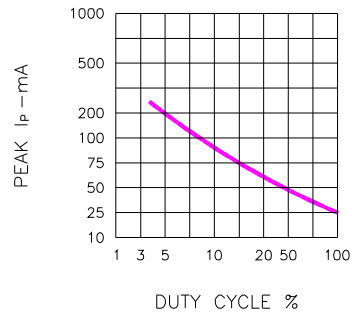

Fig.6 MAX PEAK CURRENT VS. DUTY CYCLE % (REFRESH RATE f = 1 KHz)



Spec. No.	PS-ND-08090301
Rev.	A

Model No: CSM-88131G/88141G

### ■ Package Dimensions

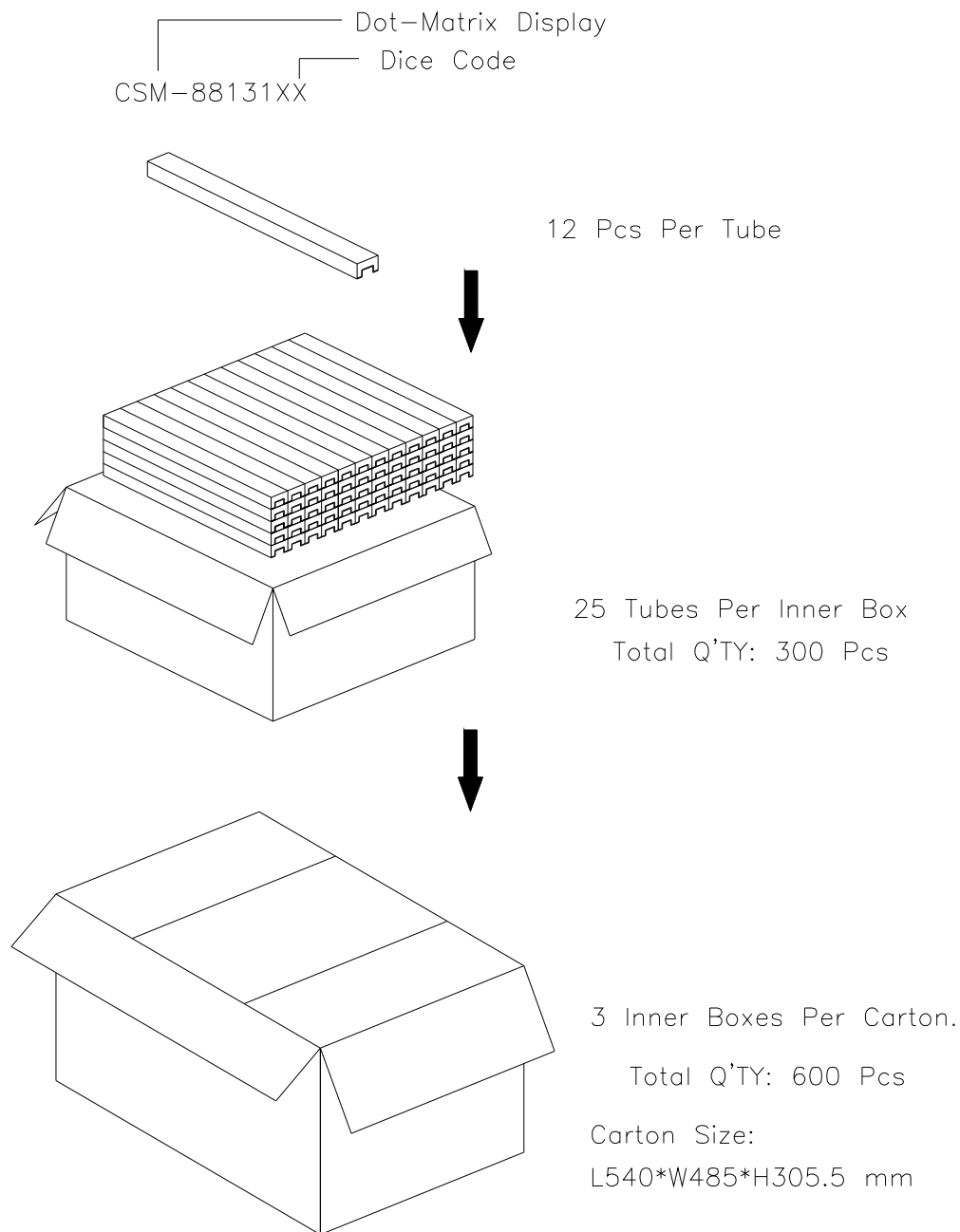

Note: The specifications are subject to change without notice. Please contact us for updated information