

Silicon Schottky Diode

- General-purpose diode for high-speed switching
- Circuit protection
- Voltage clamping
- High-level detecting and mixing
- BAS70-04S: For orientation in reel see package information below
- Pb-free (RoHS compliant) package¹⁾
- Qualified according AEC Q101

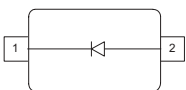

BAS170W
BAS70-02L
BAS70-02W



BAS70

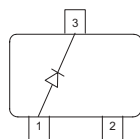

BAS70-04
BAS70-04W

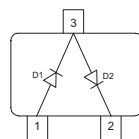

BAS70-04S

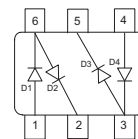

BAS70-05
BAS70-05W

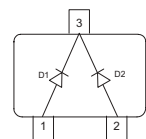

BAS70-06
BAS70-06W

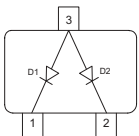

BAS70-07
BAS70-07W

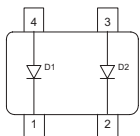

¹Pb-containing package may be available upon special request

Type	Package	Configuration	L_S (nH)	Marking
BAS170W	SOD323	single	1.8	white 7
BAS70	SOT23	single	1.8	73s
BAS70-02L	TSLP-2-1	single, leadless	0.4	F
BAS70-02W	SCD80	single	0.6	73
BAS70-04	SOT23	series	1.8	74s
BAS70-04S	SOT363	dual series	1.6	74s
BAS70-04W	SOT323	series	1.4	74s
BAS70-05	SOT23	common cathode	1.8	75s
BAS70-05W	SOT323	common cathode	1.4	75s
BAS70-06	SOT23	common anode	1.8	76s
BAS70-06W	SOT323	common anode	1.4	76s
BAS70-07	SOT143	parallel pair	2	77s
BAS70-07W	SOT343	parallel pair	1.8	77s

Maximum Ratings at $T_A = 25^\circ\text{C}$, unless otherwise specified

Parameter	Symbol	Value	Unit
Diode reverse voltage	V_R	70	V
Forward current	I_F	70	mA
Non-repetitive peak surge forward current $t \leq 10\text{ms}$	I_{FSM}	100	
Total power dissipation	P_{tot}		mW
BAS70, BAS70-07, $T_S \leq 72^\circ\text{C}$		250	
BAS70-02L, $T_S \leq 117^\circ\text{C}$		250	
BAS70-02W, $T_S \leq 107^\circ\text{C}$		250	
BAS70-04, BAS70-06, $T_S \leq 48^\circ\text{C}$		250	
BAS70-04S/W/-06W, BAS170W, $T_S \leq 97^\circ\text{C}$		250	
BAS70-05, $T_S \leq 22^\circ\text{C}$		250	
BAS70-05W, $T_S \leq 90^\circ\text{C}$		250	
BAS70-07W, $T_S \leq 114^\circ\text{C}$		250	
Junction temperature	T_j	150	$^\circ\text{C}$
Operating temperature range	T_{op}	-55 ... 125	
Storage temperature	T_{stg}	-55 ... 150	

Thermal Resistance

Parameter	Symbol	Value	Unit
Junction - soldering point ¹⁾	R_{thJS}		K/W
BAS70, BAS70-07		≤ 310	
BAS70-02L, BAS70-02W		≤ 130	
BAS70-04, BAS70-06		≤ 170	
BAS70-04S/W, BAS70-06W		≤ 410	
BAS70-05		≤ 210	
BAS70-05W		≤ 510	
BAS70-07W		≤ 240	
BAS170W		≤ 145	

Electrical Characteristics at $T_A = 25^\circ\text{C}$, unless otherwise specified

Parameter	Symbol	Values			Unit
		min.	typ.	max.	
DC Characteristics					
Breakdown voltage $I_{(BR)} = 10 \mu\text{A}$	$V_{(BR)}$	70	-	-	V
Reverse current $V_R = 50 \text{ V}$	I_R	-	-	0.1	μA
Forward voltage $I_F = 1 \text{ mA}$ $I_F = 10 \text{ mA}$ $I_F = 15 \text{ mA}$	V_F	300 600 720	375 705 880	410 750 1000	mV
Forward voltage matching ²⁾ $I_F = 10 \text{ mA}$	ΔV_F	-	-	20	

¹For calculation of R_{thJA} please refer to Application Note Thermal Resistance

² ΔV_F is the difference between lowest and highest V_F in a multiple diode component.

Electrical Characteristics at $T_A = 25^\circ\text{C}$, unless otherwise specified

Parameter	Symbol	Values			Unit
		min.	typ.	max.	
AC Characteristics					
Diode capacitance $V_R = 0$, $f = 1$ MHz	C_T	-	1.5	2	pF
Forward resistance $I_F = 10$ mA, $f = 10$ kHz	r_f	-	34	-	Ω
Charge carrier life time $I_F = 25$ mA	τ_{rr}	-	-	100	ps

Diode capacitance $C_T = f(V_R)$

$f = 1\text{MHz}$

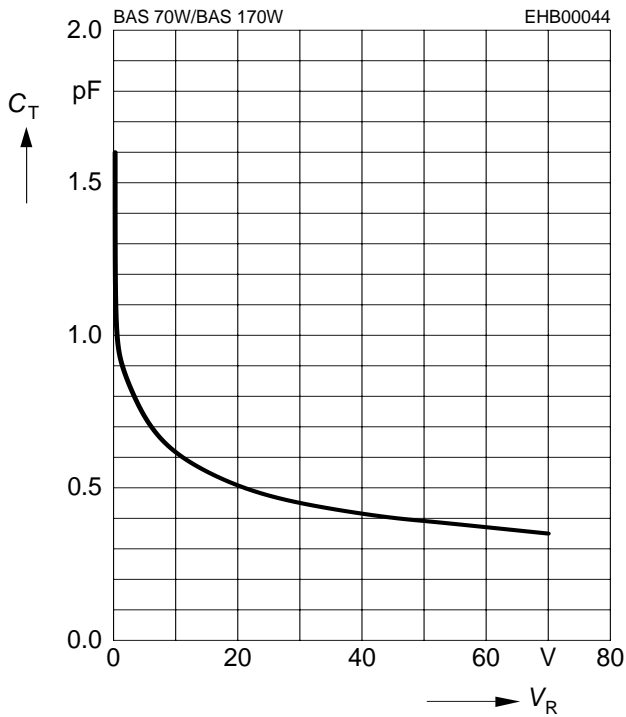

Forward resistance $r_f = f(I_F)$

$f = 10\text{kHz}$



Reverse current $I_R = f(V_R)$

$T_A = \text{Parameter}$

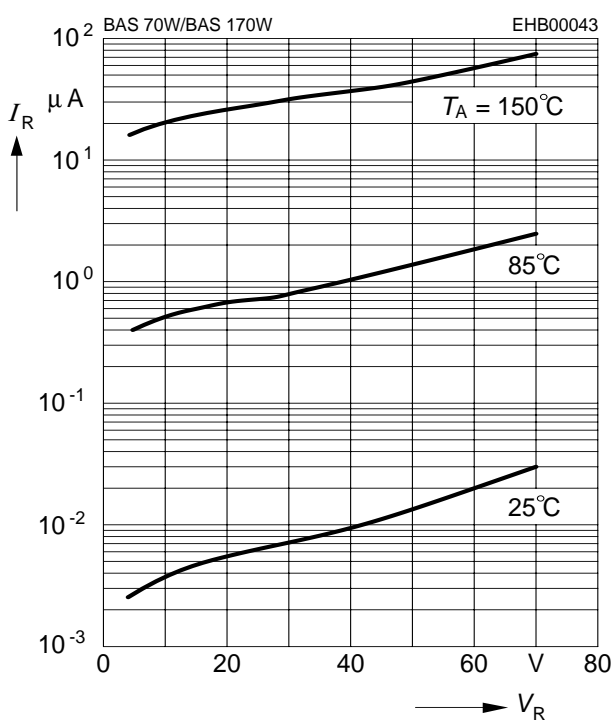

Forward current $I_F = f(V_F)$

$T_A = \text{Parameter}$



Forward current $I_F = f(T_S)$

BAS70, BAS70-07



Forward current $I_F = f(T_S)$

BAS70-02L

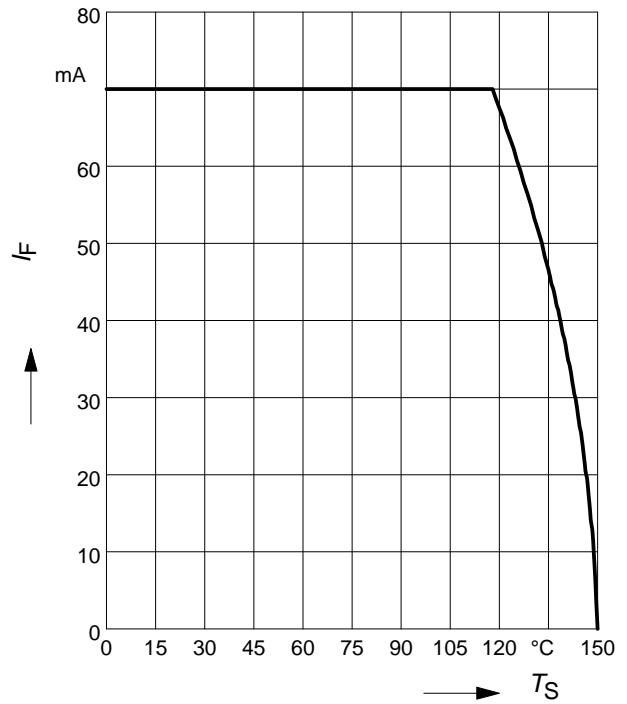

Forward current $I_F = f(T_S)$

BAS70-02W



Forward current $I_F = f(T_S)$

BAS70-04, BAS70-06

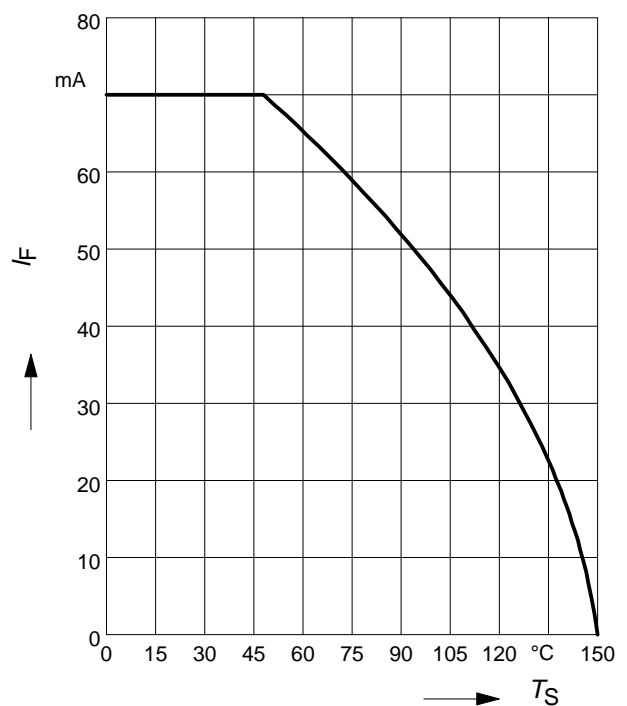

Forward current $I_F = f(T_S)$
 BAS70-04S/W, BAS70-06W, BAS170W

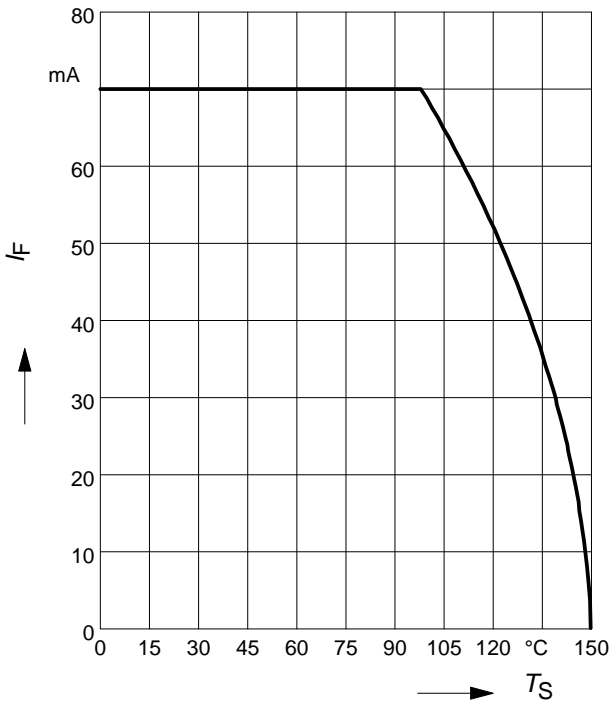

Forward current $I_F = f(T_S)$
 BAS70-05

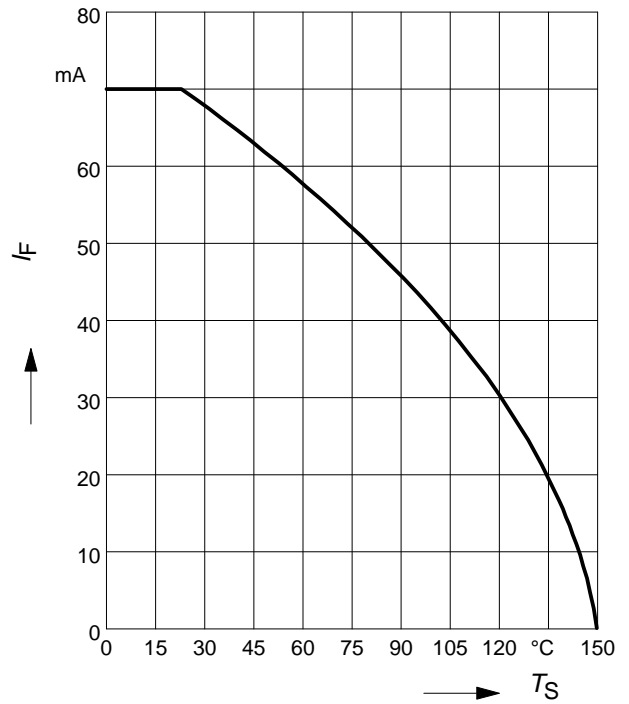

Forward current $I_F = f(T_S)$
 BAS70-05W

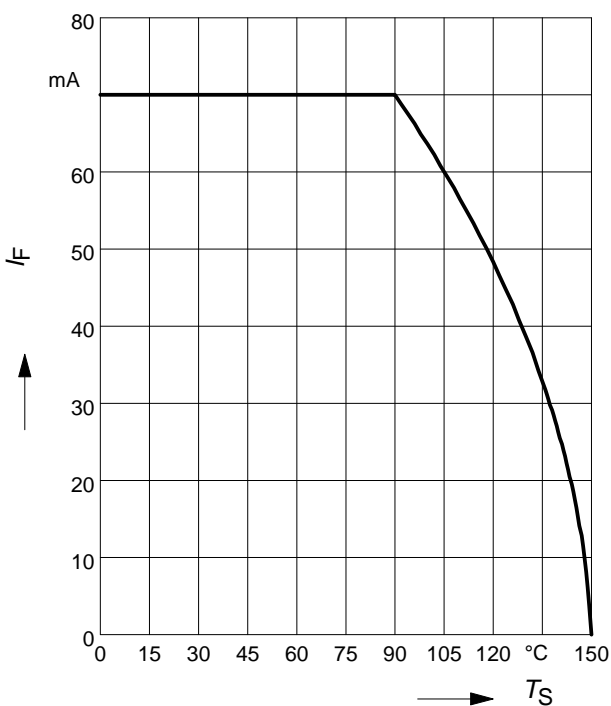

Forward current $I_F = f(T_S)$
 BAS70-07W

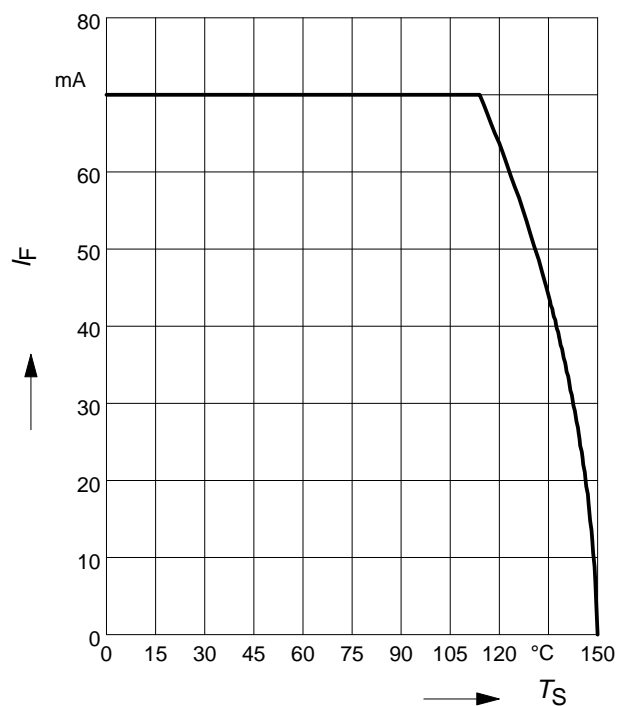

Forward current $I_F = f(T_S)$

BAS170W



Permissible Puls Load $R_{thJS} = f(t_p)$

BAS70



Permissible Pulse Load

$I_{Fmax} / I_{FDC} = f(t_p)$

BAS70

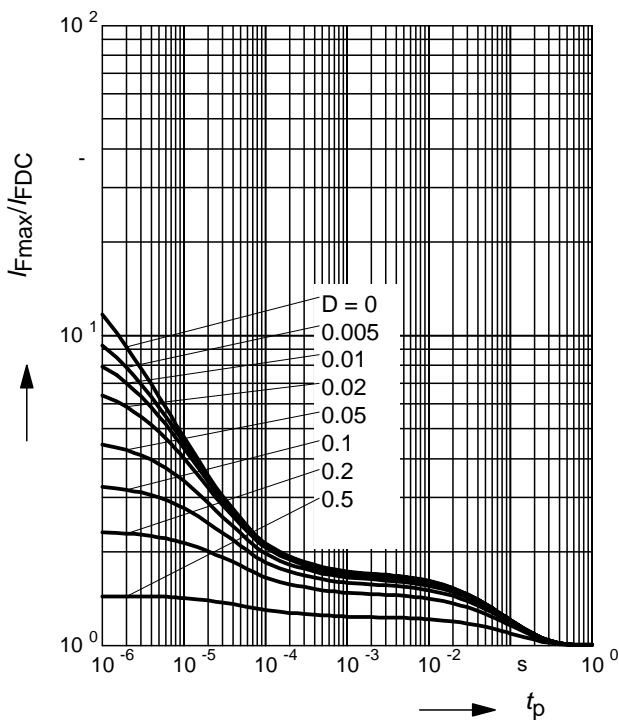

Permissible Puls Load $R_{thJS} = f(t_p)$

BAS70-02L

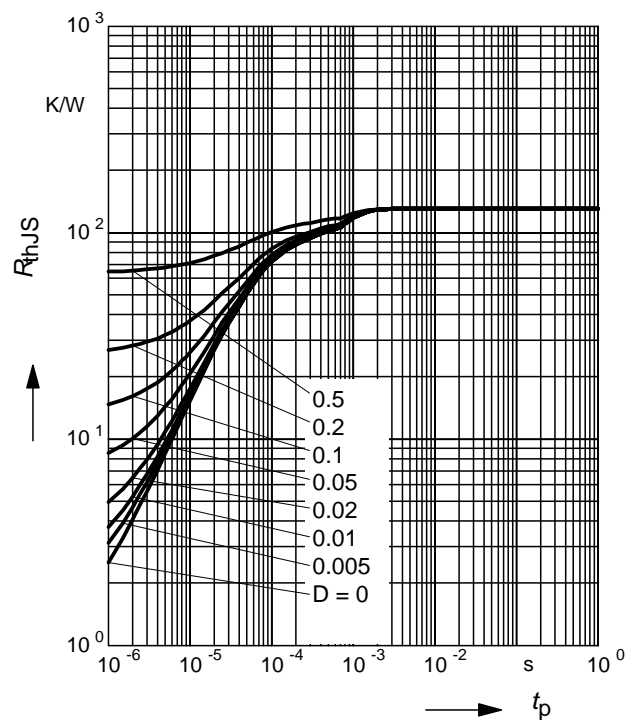

Permissible Pulse Load

$I_{Fmax} / I_{FDC} = f(t_p)$

BAS70-02L

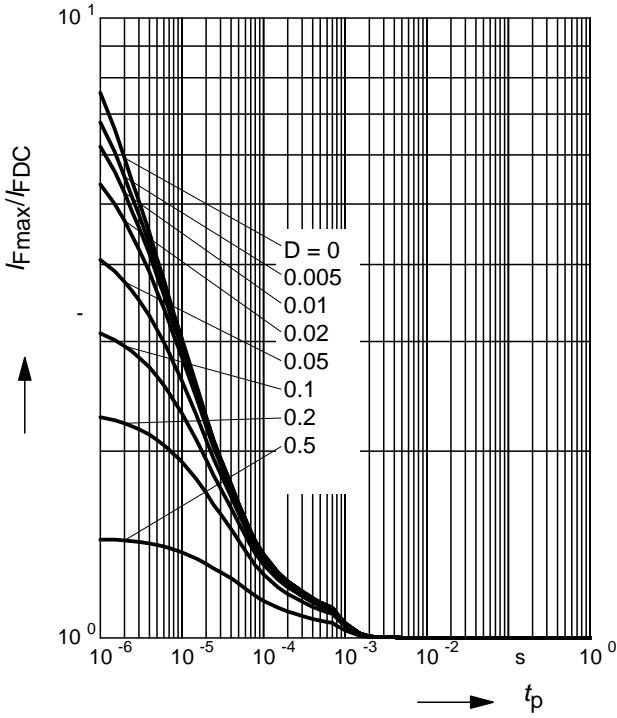

Permissible Puls Load $R_{thJS} = f(t_p)$

BAS70-02W

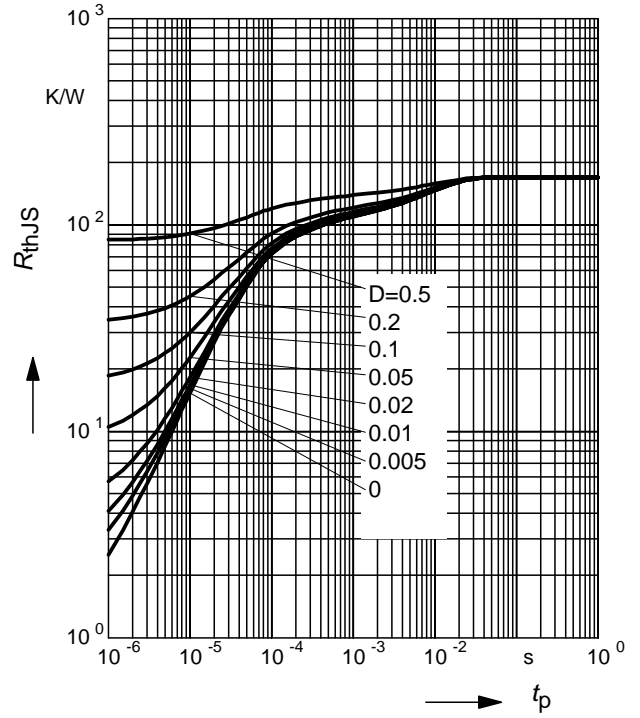

Permissible Pulse Load

$I_{Fmax} / I_{FDC} = f(t_p)$

BAS70-02W

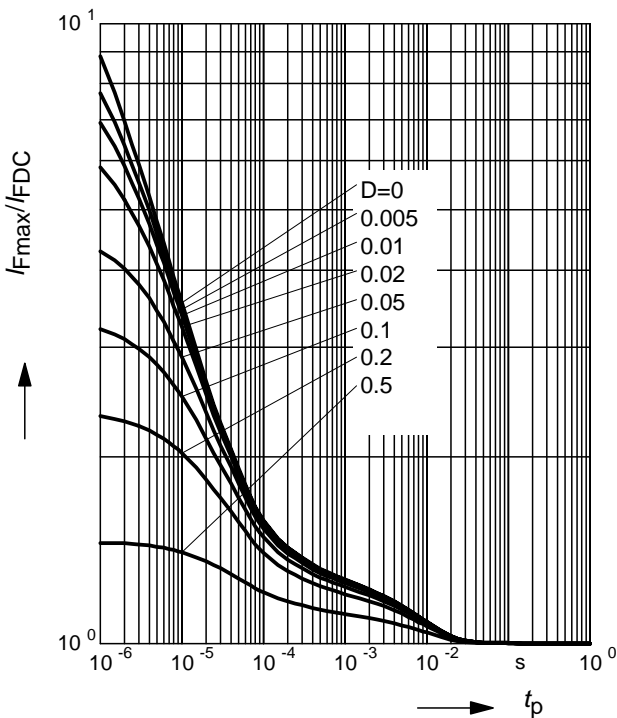

Permissible Puls Load $R_{thJS} = f(t_p)$

BAS70-04, BAS70-06

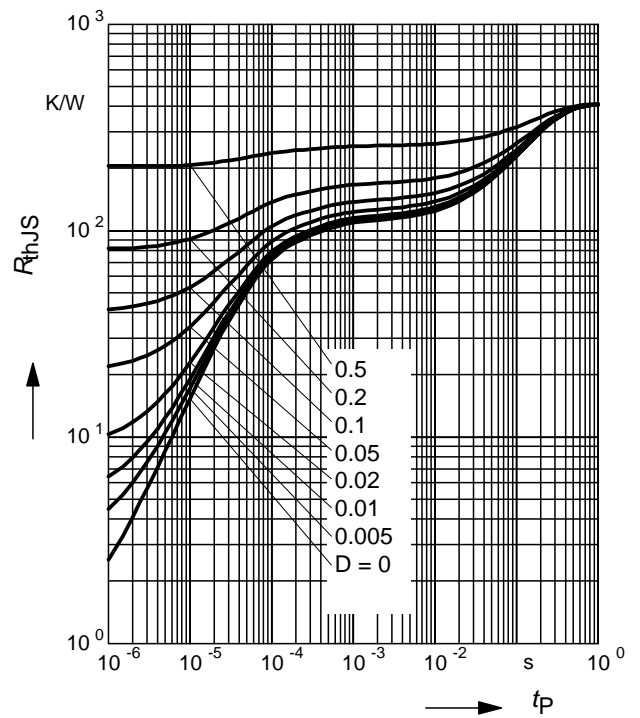

Permissible Pulse Load

$$I_{Fmax} / I_{FDC} = f(t_p)$$

BAS70-04, BAS70-06

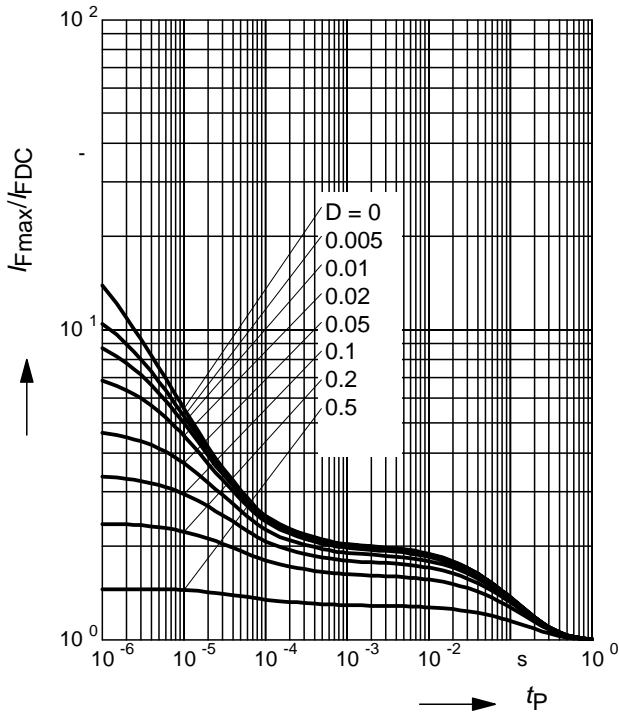

Permissible Puls Load $R_{thJS} = f(t_p)$

BAS70-04S

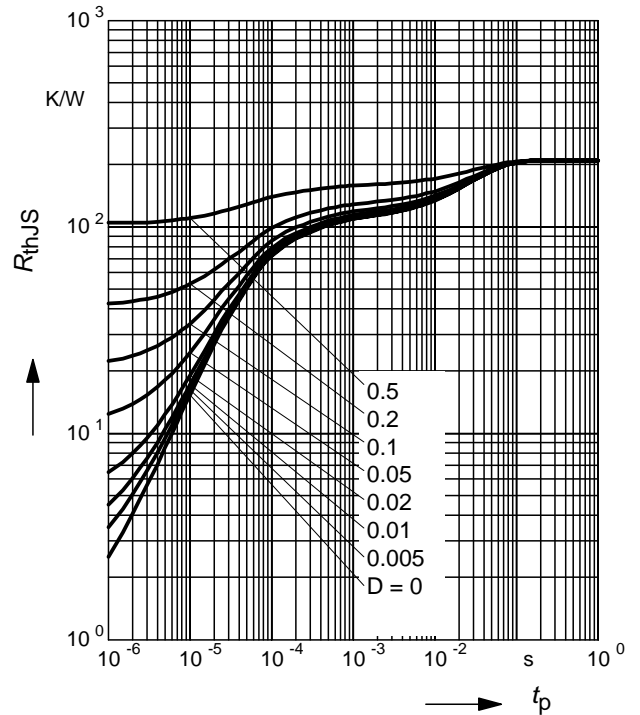

Permissible Pulse Load

$$I_{Fmax} / I_{FDC} = f(t_p)$$

BAS70-04S

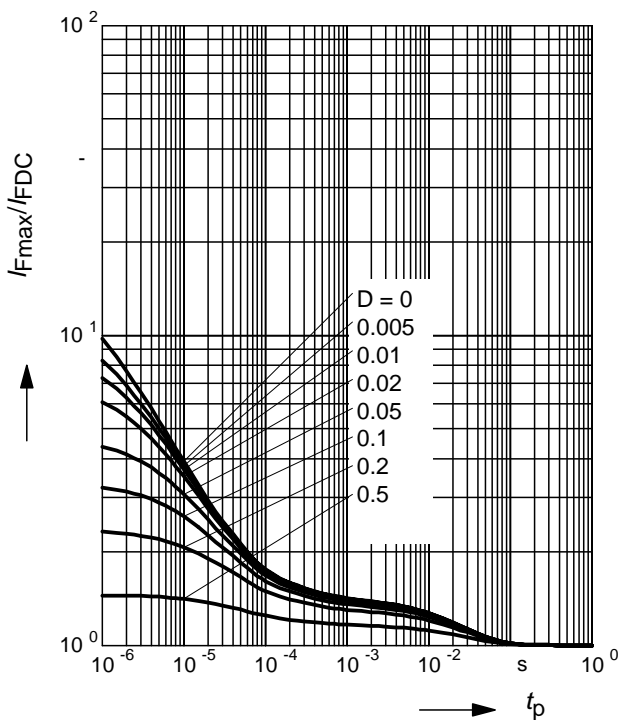

Permissible Puls Load $R_{thJS} = f(t_p)$

BAS70-04W, BAS70-06W

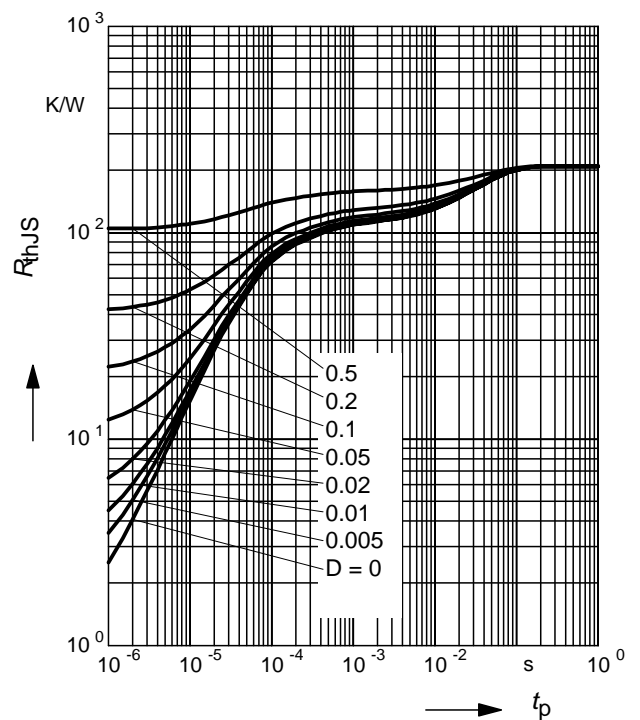

Permissible Pulse Load

$$I_{Fmax} / I_{FDC} = f(t_p)$$

BAS70-04W, BAS70-06W

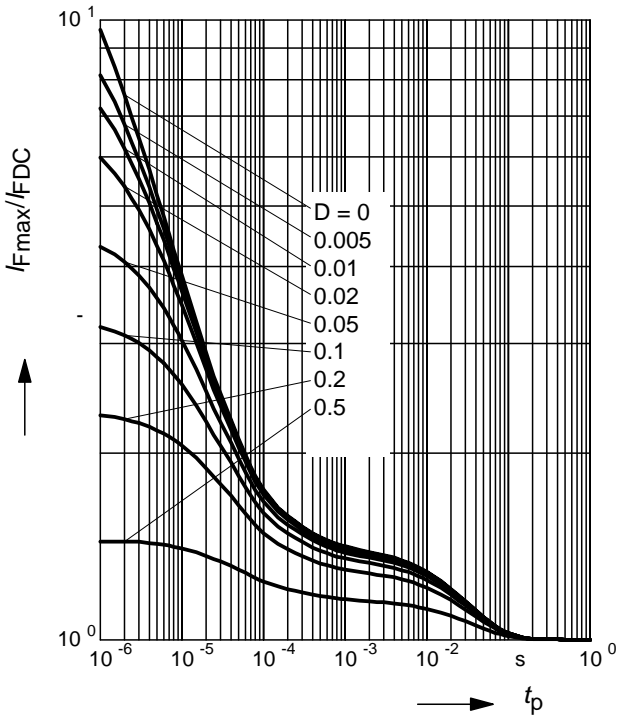

Permissible Puls Load $R_{thJS} = f(t_p)$

BAS70-05

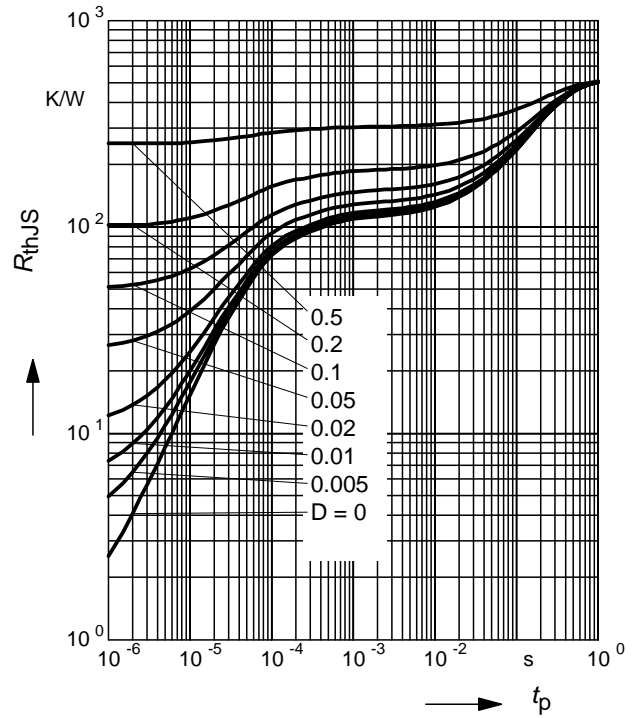

Permissible Pulse Load

$$I_{Fmax} / I_{FDC} = f(t_p)$$

BAS70-05

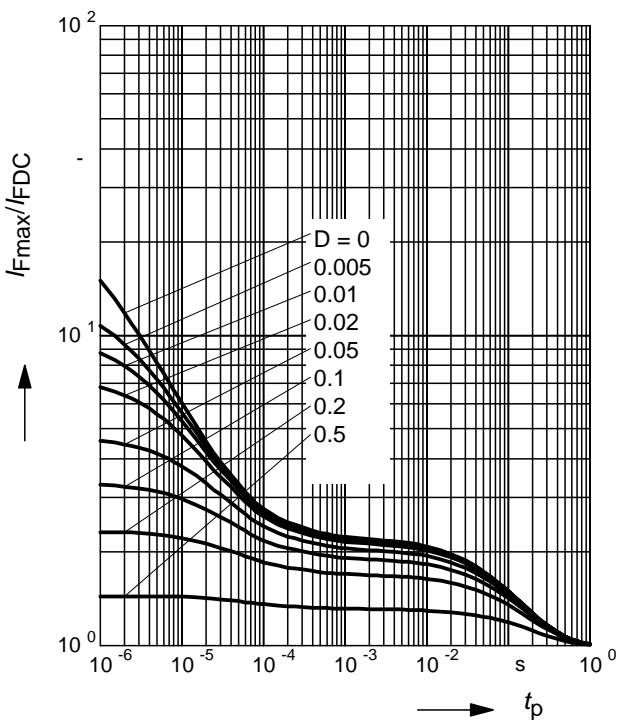

Permissible Puls Load $R_{thJS} = f(t_p)$

BAS70-05W



Permissible Pulse Load

$I_{Fmax} / I_{FDC} = f(t_p)$

BAS70-05W

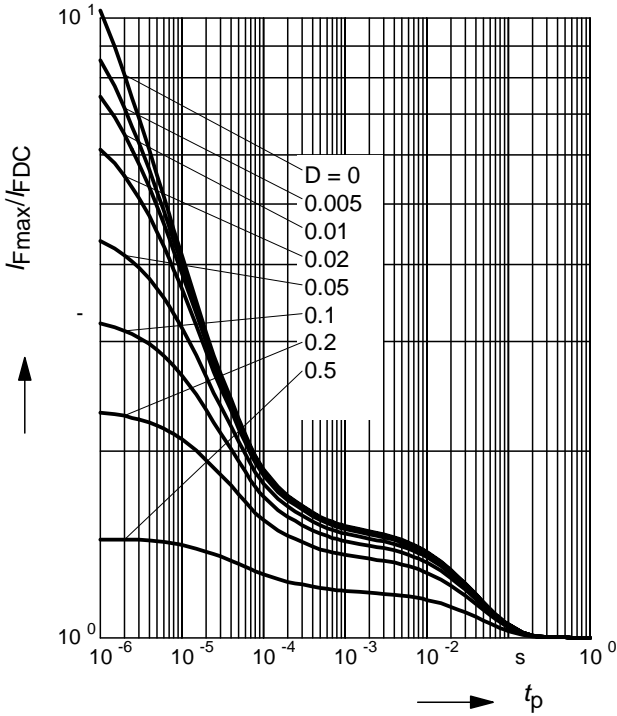

Permissible Puls Load $R_{thJS} = f(t_p)$

BAS70-07W

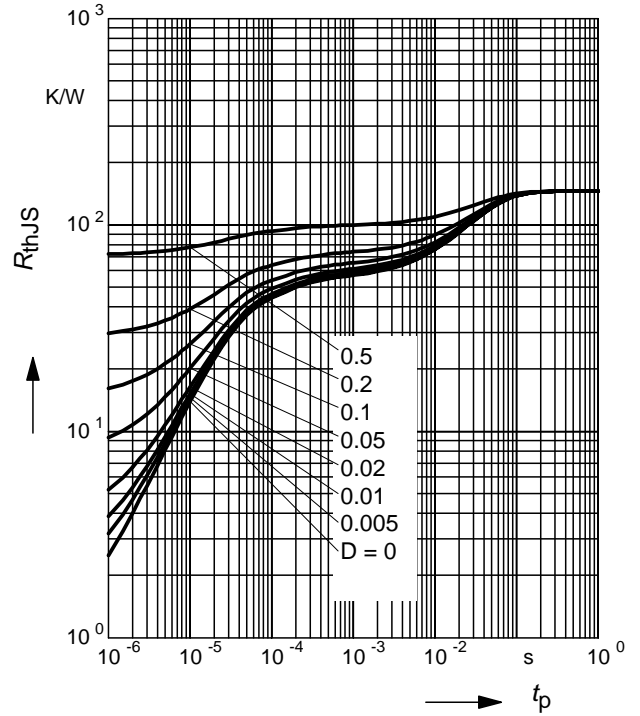

Permissible Pulse Load

$I_{Fmax} / I_{FDC} = f(t_p)$

BAS70-07W

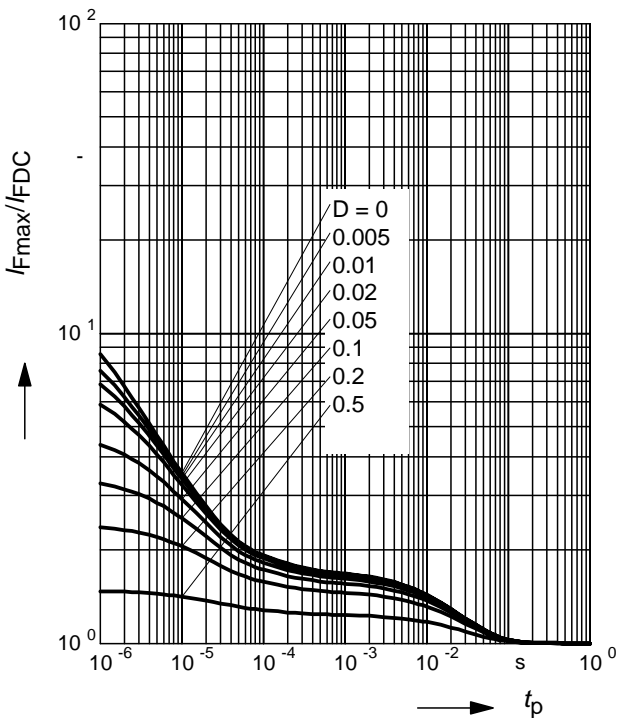

Permissible Puls Load $R_{thJS} = f(t_p)$

BAS170W

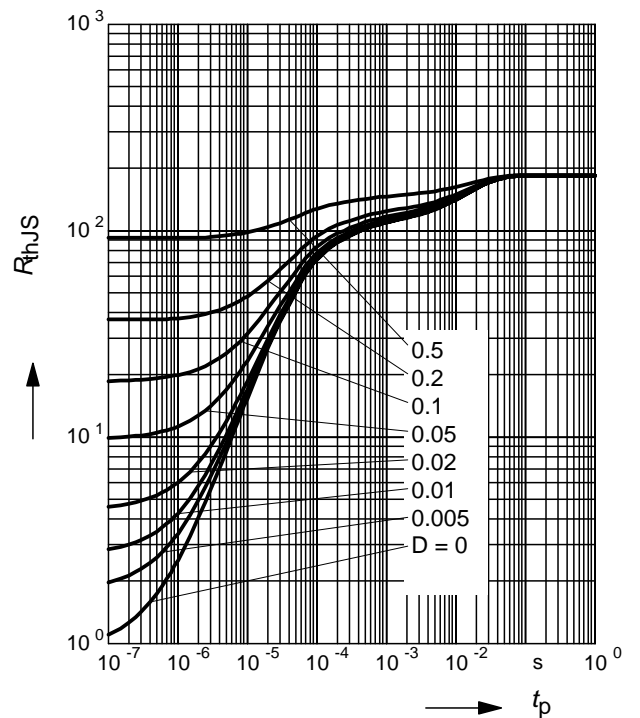

Permissible Pulse Load

$$I_{Fmax}/I_{FDC} = f(t_p)$$

BAS170W

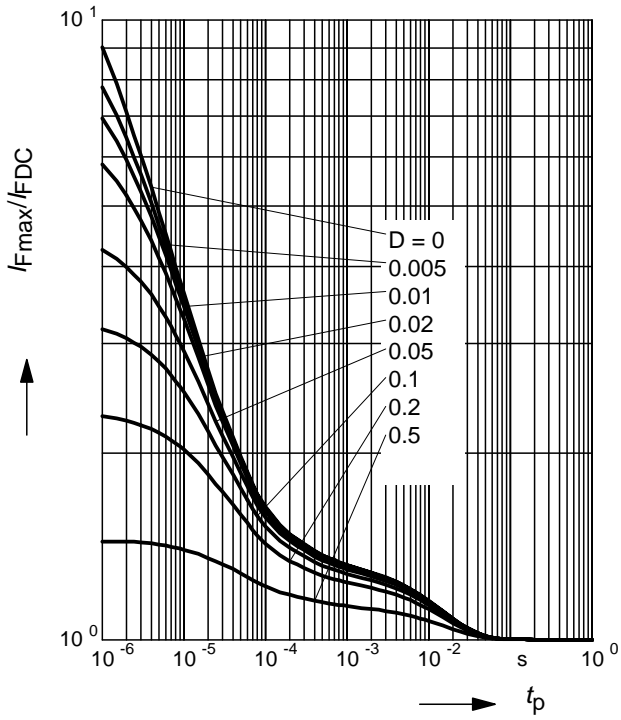

Package Outline

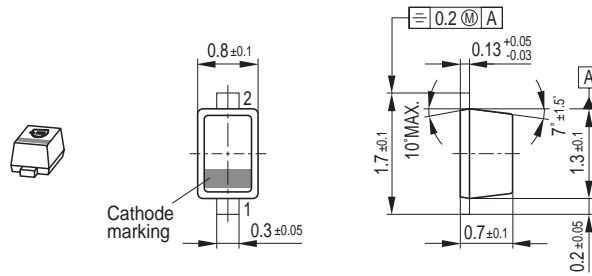

Foot Print



Marking Layout (Example)



Standard Packing

Reel \varnothing 180 mm = 3.000 Pieces/Reel
 Reel \varnothing 180 mm = 8.000 Pieces/Reel (2 mm Pitch)
 Reel \varnothing 330 mm = 10.000 Pieces/Reel

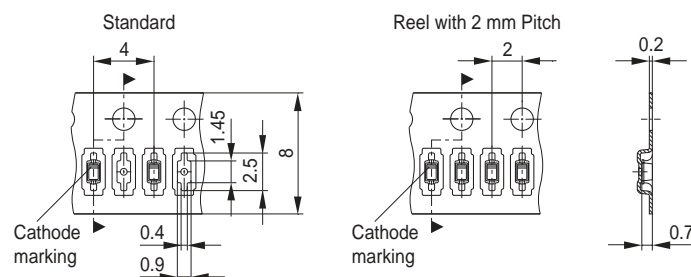

Date Code marking for discrete packages with one digit (SCD80, SC79, SC75¹⁾) CES-Code

Month	2003	2004	2005	2006	2007	2008	2009	2010	2011	2012	2013	2014
01	a	p	A	P	a	p	A	P	a	p	A	P
02	b	q	B	Q	b	q	B	Q	b	q	B	Q
03	c	r	C	R	c	r	C	R	c	r	C	R
04	d	s	D	S	d	s	D	S	d	s	D	S
05	e	t	E	T	e	t	E	T	e	t	E	T
06	f	u	F	U	f	u	F	U	f	u	F	U
07	g	v	G	V	g	v	G	V	g	v	G	V
08	h	x	H	X	h	x	H	X	h	x	H	X
09	j	y	J	Y	j	y	J	Y	j	y	J	Y
10	k	z	K	Z	k	z	K	Z	k	z	K	Z
11	l	2	L	4	l	2	L	4	l	2	L	4
12	n	3	N	5	n	3	N	5	n	3	N	5

1) New Marking Layout for SC75, implemented at October 2005.

Package Outline

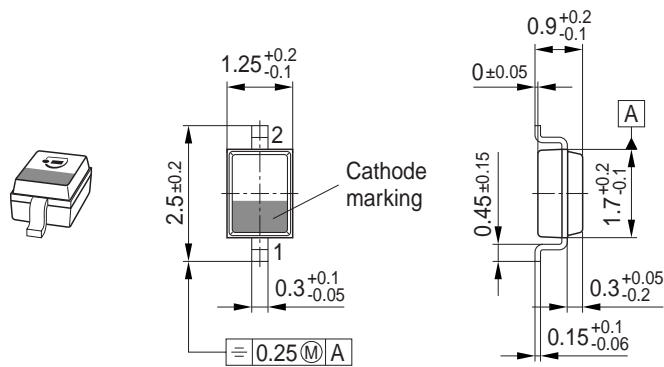

Foot Print

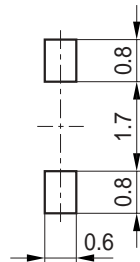

Marking Layout (Example)

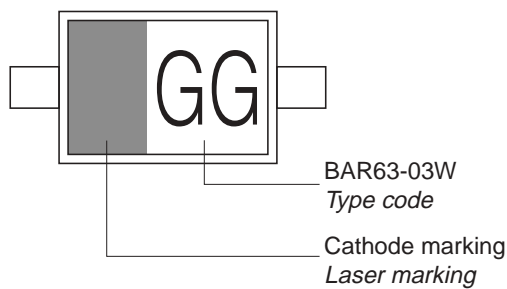

Standard Packing

Reel \varnothing 180 mm = 3.000 Pieces/Reel
 Reel \varnothing 330 mm = 10.000 Pieces/Reel

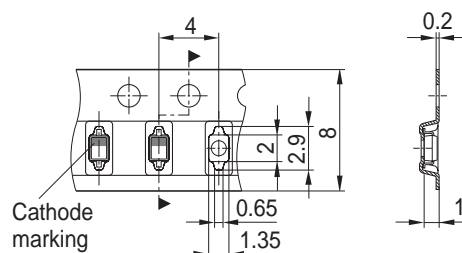

Package Outline

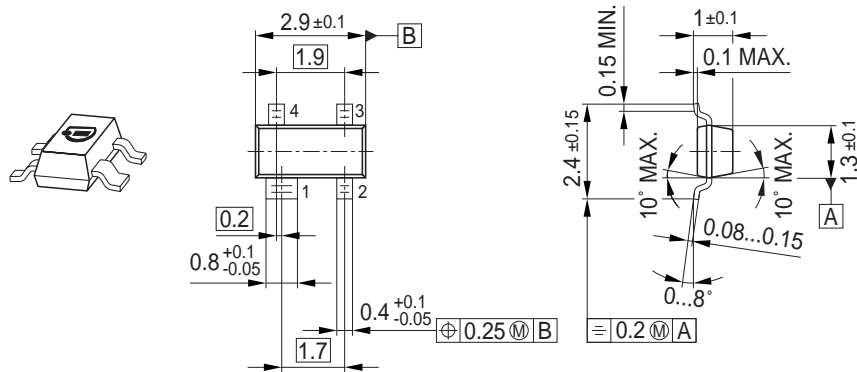

Foot Print

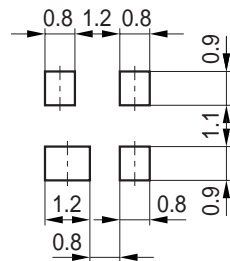

Marking Layout (Example)

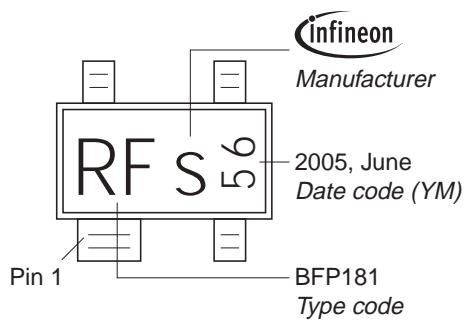

Standard Packing

Reel $\varnothing 180$ mm = 3.000 Pieces/Reel
 Reel $\varnothing 330$ mm = 10.000 Pieces/Reel

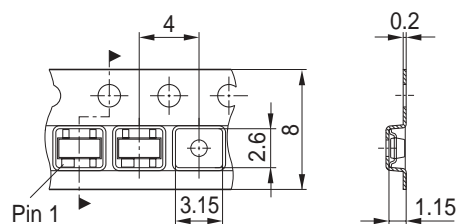

Package Outline



1) Lead width can be 0.6 max. in dambar area

Foot Print



Marking Layout (Example)

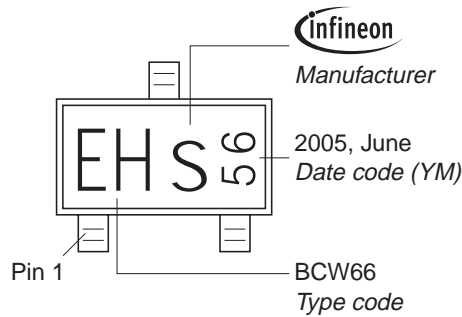

Standard Packing

Reel \varnothing 180 mm = 3.000 Pieces/Reel
 Reel \varnothing 330 mm = 10.000 Pieces/Reel

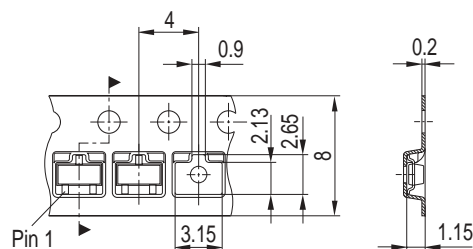

Package Outline

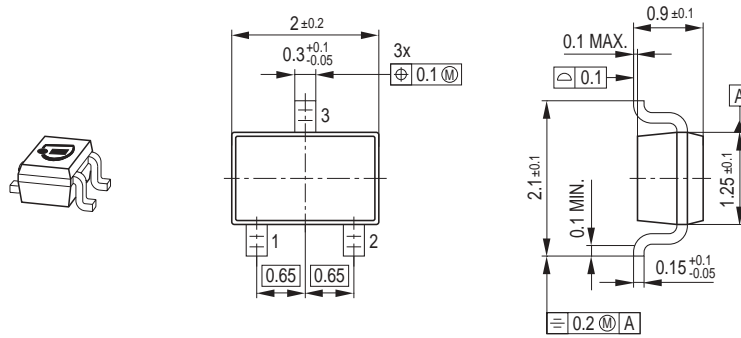

Foot Print

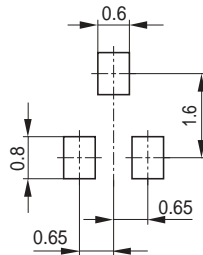

Marking Layout (Example)

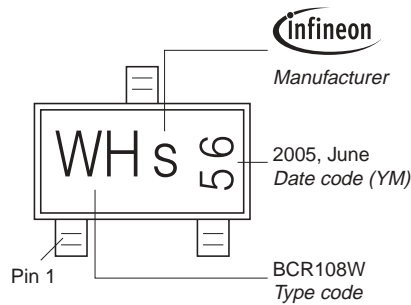

Standard Packing

Reel $\varnothing 180$ mm = 3.000 Pieces/Reel
 Reel $\varnothing 330$ mm = 10.000 Pieces/Reel

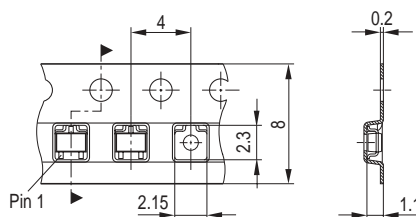

Package Outline

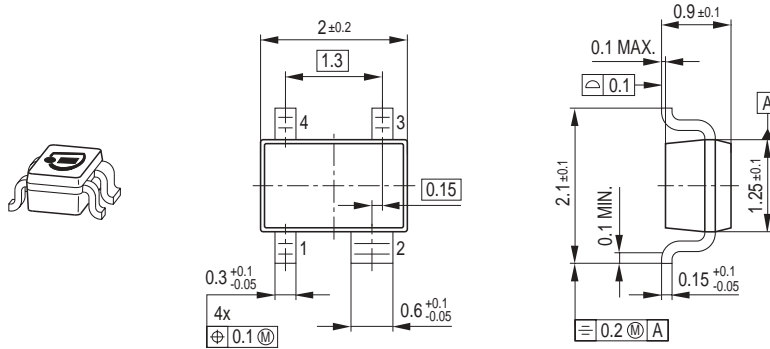

Foot Print

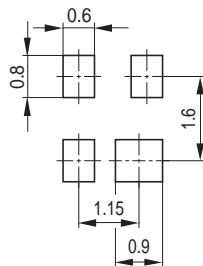

Marking Layout (Example)

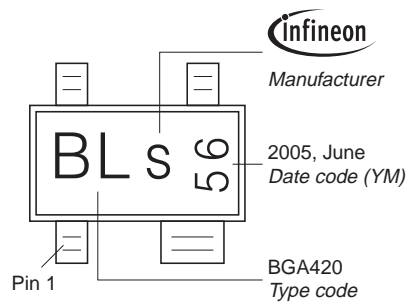

Standard Packing

Reel ø180 mm = 3.000 Pieces/Reel
 Reel ø330 mm = 10.000 Pieces/Reel

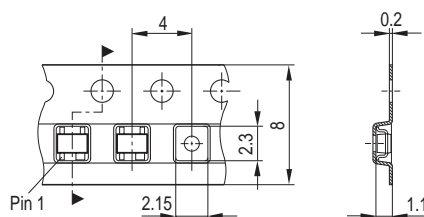

Package Outline

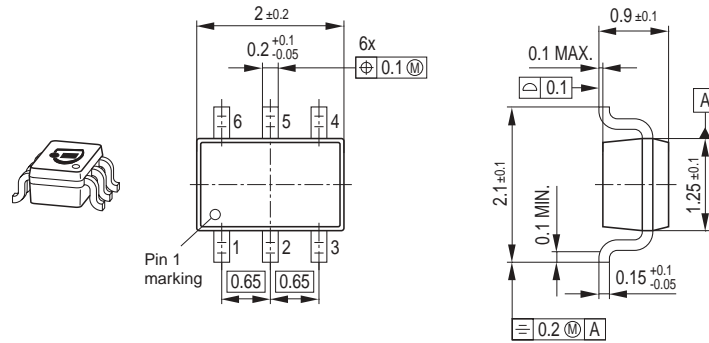

Foot Print

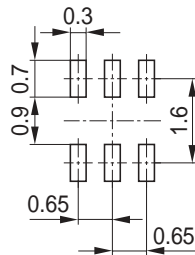

Marking Layout (Example)

Small variations in positioning of Date code, Type code and Manufacture are possible.

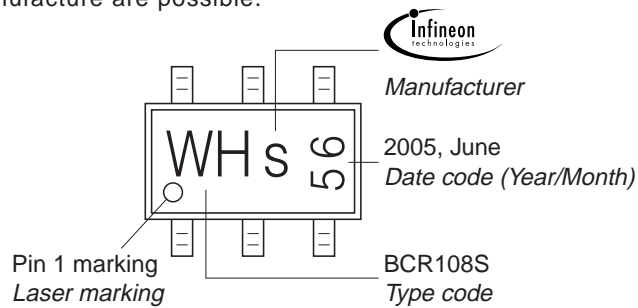

Standard Packing

Reel \varnothing 180 mm = 3.000 Pieces/Reel
 Reel \varnothing 330 mm = 10.000 Pieces/Reel

For symmetric types no defined Pin 1 orientation in reel.

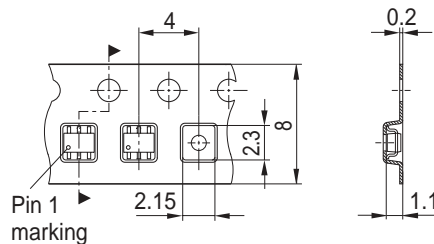

Package Outline



1) Dimension applies to plated terminal

Foot Print

For board assembly information please refer to Infineon website "Packages"



■ Copper □ Solder mask

▨ Stencil apertures

Marking Layout (Example)

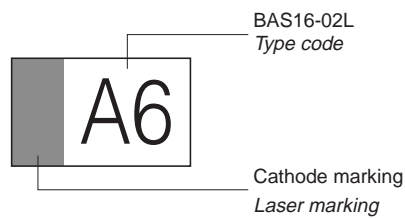

BAS16-02L
Type code

Cathode marking
Laser marking

Standard Packing

Reel \varnothing 180 mm = 15.000 Pieces/Reel
Reel \varnothing 330 mm = 50.000 Pieces/Reel (optional)

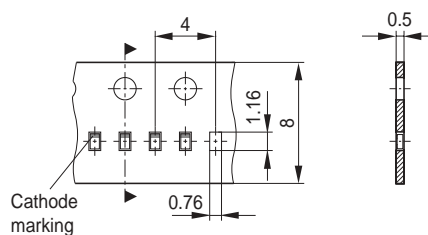

Edition 2006-02-01

Published by

Infineon Technologies AG

81726 München, Germany

© Infineon Technologies AG 2007.

All Rights Reserved.

Attention please!

The information given in this dokument shall in no event be regarded as a guarantee of conditions or characteristics ("Beschaffenhheitsgarantie"). With respect to any examples or hints given herein, any typical values stated herein and/or any information regarding the application of the device, Infineon Technologies hereby disclaims any and all warranties and liabilities of any kind, including without limitation warranties of non-infringement of intellectual property rights of any third party.

Information

For further information on technology, delivery terms and conditions and prices please contact your nearest Infineon Technologies Office (www.infineon.com).

Warnings

Due to technical requirements components may contain dangerous substances. For information on the types in question please contact your nearest Infineon Technologies Office.

Infineon Technologies Components may only be used in life-support devices or systems with the express written approval of Infineon Technologies, if a failure of such components can reasonably be expected to cause the failure of that life-support device or system, or to affect the safety or effectiveness of that device or system.

Life support devices or systems are intended to be implanted in the human body, or to support and/or maintain and sustain and/or protect human life. If they fail, it is reasonable to assume that the health of the user or other persons may be endangered.