

CURRENT SENSE HIGH SIDE SWITCH

Features

- Suitable for 24V systems
- Over current shutdown
- Over temperature shutdown
- Current sensing
- Active clamp
- Low current
- ESD protection
- Optimized Turn On/Off for EMI

Applications

- 21W Filament lamp
- Solenoid
- 24V loads for trucks

Description

The AUIPS7141R is a fully protected four terminal high side switch specifically designed for driving lamp. It features current sensing, over-current, over-temperature, ESD protection and drain to source active clamp. When the input voltage $V_{cc} - V_{in}$ is higher than the specified threshold, the output power Mosfet is turned on. When the $V_{cc} - V_{in}$ is lower than the specified V_{il} threshold, the output Mosfet is turned off. The I_{fb} pin is used for current sensing. The over-current shutdown is higher than inrush current of the lamp.

Typical Connection

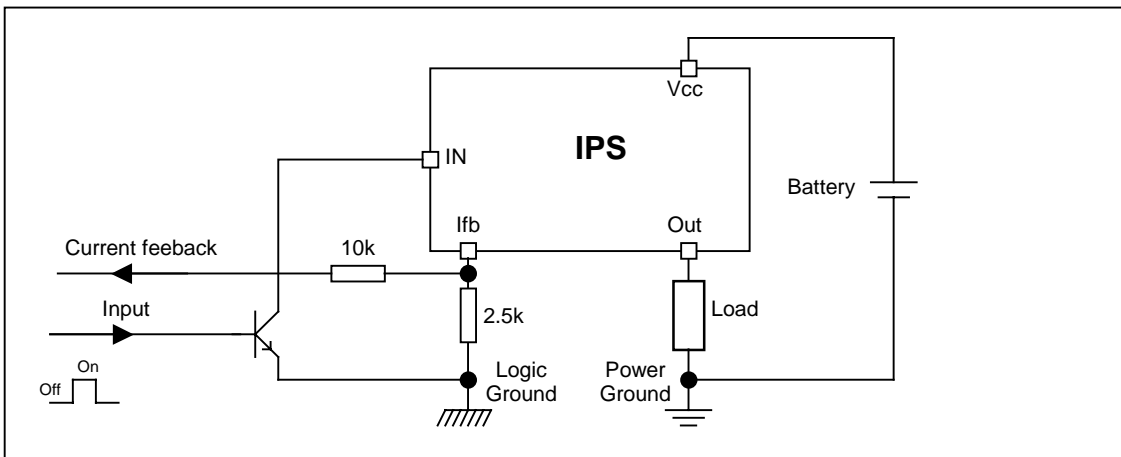

Product Summary

$R_{ds(on)}$	100m Ω max.
V_{clamp}	65V
Current shutdown	20A min.

Packages



DPak

Qualification Information[†]

Qualification Level		Automotive (per AEC-Q100 ^{††})	
		Comments: This family of ICs has passed an Automotive qualification. IR's Industrial and Consumer qualification level is granted by extension of the higher Automotive level.	
Moisture Sensitivity Level		<p style="text-align: center;">DPAK-5L</p>	<p style="text-align: center;">MSL1, 260°C (per IPC/JEDEC J-STD-020)</p>
ESD	Machine Model	Class M2 (200 V) (per AEC-Q100-003)	
	Human Body Model	Class H1C (1500 V) (per AEC-Q100-002)	
	Charged Device Model	Class C5 (1000 V) (per AEC-Q100-011)	
IC Latch-Up Test		Class II, Level A (per AEC-Q100-004)	
RoHS Compliant		Yes	

† Qualification standards can be found at International Rectifier's web site <http://www.irf.com/>

†† Exceptions to AEC-Q100 requirements are noted in the qualification report.

††† Higher MSL ratings may be available for the specific package types listed here. Please contact your International Rectifier sales representative for further information.

Absolute Maximum Ratings

Absolute maximum ratings indicate sustained limits beyond which damage to the device may occur. (T_{ambient}=25°C unless otherwise specified).

Symbol	Parameter	Min.	Max.	Units
V _{out}	Maximum output voltage	V _{cc} -60	V _{cc} +0.3	V
V _{cc} -V _{in} max.	Maximum V _{cc} voltage	-16	60	V
I _{fb} , max.	Maximum feedback current	-50	10	mA
V _{cc} sc.	Maximum V _{cc} voltage with short circuit protection see page 7	—	50	V
P _d	Maximum power dissipation (internally limited by thermal protection) R _{th} =50°C/W DPack 6cm ² footprint	—	2.5	W
T _j max.	Max. storage & operating junction temperature	-40	150	°C

Thermal Characteristics

Symbol	Parameter	Typ.	Max.	Units
R _{th1}	Thermal resistance junction to ambient DPak Std footprint	70	—	°C/W
R _{th2}	Thermal resistance junction to ambient Dpak 6cm ² footprint	50	—	
R _{th3}	Thermal resistance junction to case Dpak	4	—	

Recommended Operating Conditions

These values are given for a quick design.

Symbol	Parameter	Min.	Max.	Units
I _{out}	Continuous output current, T _{ambient} =85°C, T _j =125°C R _{th} =50°C/W, Dpak 6cm ² footprint	—	2.1	A
R _{lfb}	I _{fb} resistor	1.5	—	kΩ

Static Electrical Characteristics

T_J=25°C, V_{CC}=28V (unless otherwise specified)

Symbol	Parameter	Min.	Typ.	Max.	Units	Test Conditions
V _{CC op.}	Operating voltage	6	—	60	V	
R _{ds(on)}	ON state resistance T _J =25°C	—	75	100	mΩ	I _{ds} =2A
	ON state resistance T _J =150°C(2)	—	135	180		
I _{CC off}	Supply leakage current	—	1	3	μA	V _{in} =V _{CC} / V _{ifb} =V _{gnd} V _{out} =V _{gnd}
I _{out off}	Output leakage current	—	1	3		
I _{in on}	Input current while on	0.6	1.6	3	V	V _{CC} -V _{in} =28V
V _{clamp1}	V _{CC} to V _{out} clamp voltage 1	60	64	—		I _d =10mA
V _{clamp2}	V _{CC} to V _{out} clamp voltage 2	60	65	72		I _d =6A see fig. 2
V _{ih(1)}	High level Input threshold voltage	—	3	4.5		I _d =10mA
V _{il(1)}	Low level Input threshold voltage	1.5	2.3	—		
V _f	Forward body diode voltage T _J =25°C	—	0.8	0.9		I _f =1A
	Forward body diode voltage T _J =125°C	—	0.65	0.75		

(1) Input thresholds are measured directly between the input pin and the tab.

Switching Electrical Characteristics

V_{CC}=28V, Resistive load=27Ω, T_J=25°C

Symbol	Parameter	Min.	Typ.	Max.	Units	Test Conditions
t _{don}	Turn on delay time to 20%	4	10	20	μs	See fig. 1
t _r	Rise time from 20% to 80% of V _{CC}	2	5	10		
t _{doff}	Turn off delay time	20	40	80	μs	
t _f	Fall time from 80% to 20% of V _{CC}	2.5	5	10		

Protection Characteristics

Symbol	Parameter	Min.	Typ.	Max.	Units	Test Conditions
T _{sd}	Over temperature threshold	150(2)	165	—	°C	See fig. 3 and fig.11
I _{sd}	Over-current shutdown	20	25	35	A	See fig. 3 and page 6
I _{fault}	I _{fb} after an over-current or an over-temperature (latched)	2.7	3.3	4	mA	See fig. 3

Current Sensing Characteristics

Symbol	Parameter	Min.	Typ.	Max.	Units	Test Conditions
Ratio	I _{load} / I _{fb} current ratio	2000	2400	2800		I _{load} =2A
Ratio_TC	I _{load} / I _{fb} variation over temperature(2)	-5%	0	+5	%	T _J =-40°C to +150°C
I _{offset}	Load current offset	-0.2	0	0.2	A	I _{out} <2A
I _{fb leakage}	I _{fb} leakage current On in open load	0	8	100	μA	I _{out} =0A

(2) Guaranteed by design

Lead Assignments

- 1- NC
- 2- In
- 3- Vcc
- 4- Ifb
- 5- Out

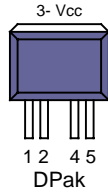

Functional Block Diagram

All values are typical

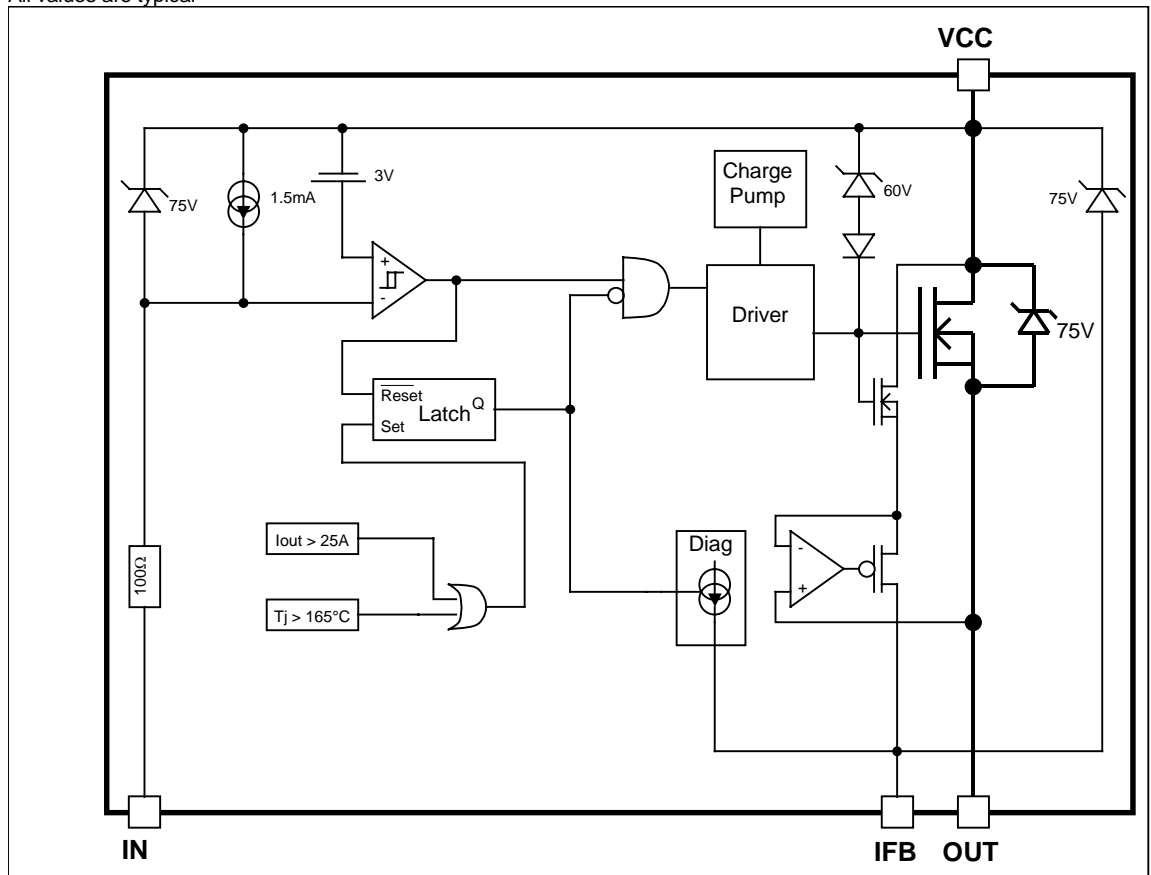

Truth Table

Op. Conditions	Input	Output	I _{fb} pin voltage
Normal mode	H	L	0V
Normal mode	L	H	I _{load} x R _{fb} / Ratio
Open load	H	L	0V
Open load	L	H	0V
Short circuit to GND	H	L	0V
Short circuit to GND	L	L	V fault (latched)
Over temperature	H	L	0V
Over temperature	L	L	V fault (latched)

Operating voltage

Maximum V_{cc} voltage : this is the maximum voltage before the breakdown of the IC process.

Operating voltage : This is the V_{cc} range in which the functionality of the part is guaranteed. The AEC-Q100 qualification is run at the maximum operating voltage specified in the datasheet.

Reverse battery

During the reverse battery the Mosfet is kept off and the load current is flowing into the body diode of the power Mosfet. Power dissipation in the IPS : P = I_{load} * V_f

If the power dissipation is too high in R_{fb}, a diode in serial can be added to block the current.

The transistor used to pull-down the input should be a bipolar in order to block the reverse current. The 100ohm input resistor can not sustain continuously 16V (see V_{cc}-V_{in} max. in the Absolute Maximum Ratings section)

Active clamp

The purpose of the active clamp is to limit the voltage across the MOSFET to a value below the body diode break down voltage to reduce the amount of stress on the device during switching.

The temperature increase during active clamp can be estimated as follows:

$$\Delta T_{Tj} = P_{CL} \cdot Z_{TH}(t_{CLAMP})$$

Where: Z_{TH}(t_{CLAMP}) is the thermal impedance at t_{CLAMP} and can be read from the thermal impedance curves given in the data sheets.

P_{CL} = V_{CL} · I_{CLavg} : Power dissipation during active clamp

V_{CL} = 65V : Typical V_{CLAMP} value.

$$I_{CLavg} = \frac{I_{CL}}{2} : \text{Average current during active clamp}$$

$$t_{CL} = \frac{I_{CL}}{\left| \frac{di}{dt} \right|} : \text{Active clamp duration}$$

$$\frac{di}{dt} = \frac{V_{Battery} - V_{CL}}{L} : \text{Demagnetization current}$$

Figure 9 gives the maximum inductance versus the load current in the worst case : the part switches off after an over temperature detection. If the load inductance exceeds the curve, a free wheeling diode is required.

Over-current protection

The threshold of the over-current protection is set in order to guarantee that the device is able to turn on a load with an inrush current lower than the minimum of I_{sd}. Nevertheless for high current and high temperature the device may switch off for a lower current due to the over-temperature protection. This behavior is shown in Figure 11.

Current sensing accuracy

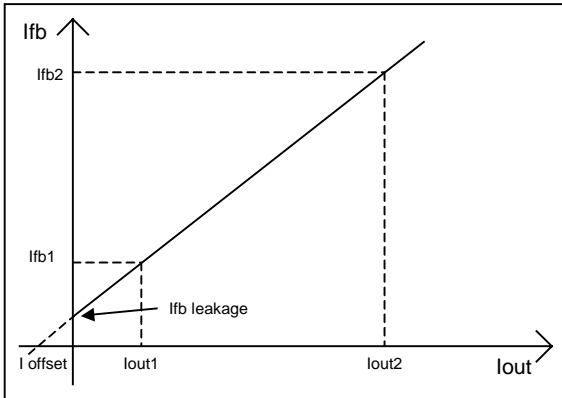

The current sensing is specified by measuring 3 points :

- I_fb1 for I_out1
- I_fb2 for I_out2
- I_fb leakage for I_out=0

The parameters in the datasheet are computed with the following formula :

$$\text{Ratio} = (I_{out2} - I_{out1}) / (I_{fb2} - I_{fb1})$$

$$I_{offset} = I_{fb1} \times \text{Ratio} - I_{out1}$$

This allows the designer to evaluate the I_fb for any I_out value using :

$$I_{fb} = (I_{out} + I_{offset}) / \text{Ratio} \text{ if } I_{fb} > I_{fb \text{ leakage}}$$

For some applications, a calibration is required. In that case, the accuracy of the system will depend on the variation of the I_offset and the ratio over the temperature range. The ratio variation is given by Ratio_TC specified in page 4.

The I_offset variation depends directly on the R_dson :

$$I_{offset@-40^\circ\text{C}} = I_{offset@25^\circ\text{C}} / 0.8$$

$$I_{offset@150^\circ\text{C}} = I_{offset@25^\circ\text{C}} / 1.9$$

Maximum Vcc voltage with short circuit protection

The maximum Vcc voltage with short circuit is the maximum voltage for which the part is able to protect itself under test conditions representative of the application. 2 kind of short circuits are considered : terminal and load short circuit.

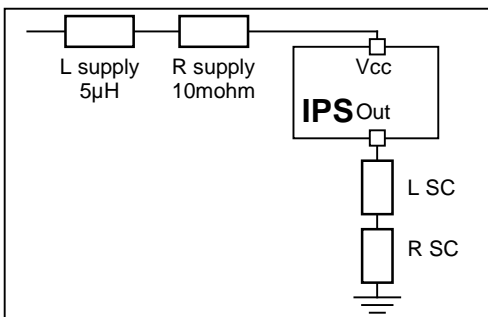

	L SC	R SC
Terminal SC	0.1 µH	10 mohm
Load SC	10 µH	100 mohm

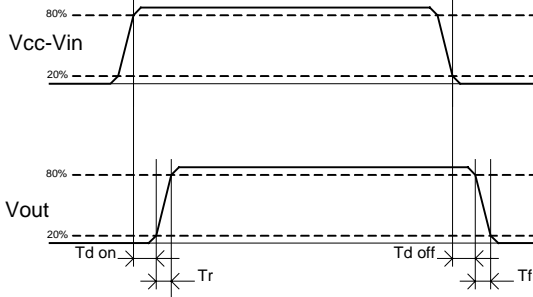
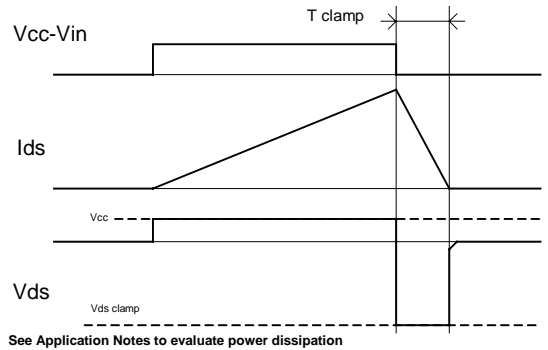

Figure 1 – IN rise time & switching definitions



See Application NOTES to evaluate power dissipation

Figure 2 – Active clamp waveforms

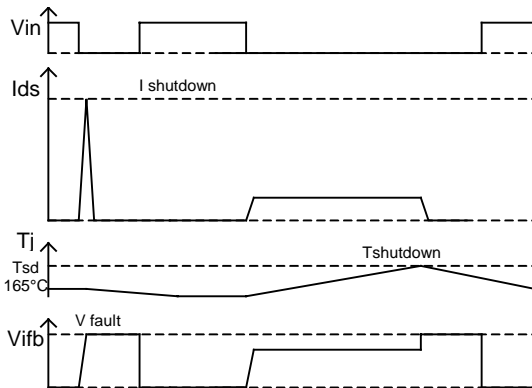

Figure 3 – Protection timing diagram

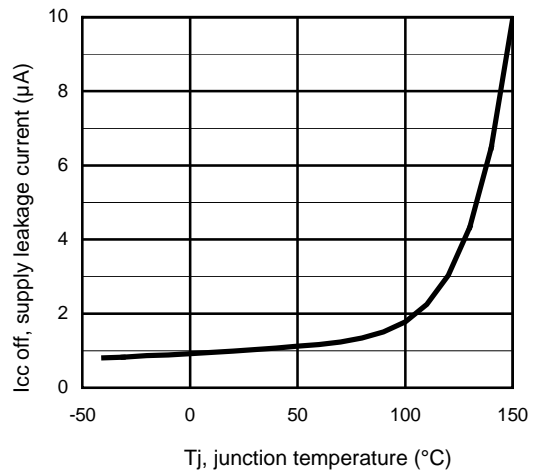

Figure 4 – Icc off (µA) Vs Tj (°C)

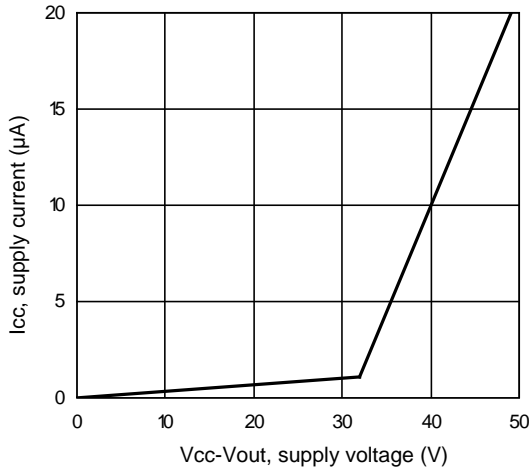

Figure 5 – Icc off (µA) Vs Vcc-Vout (V)

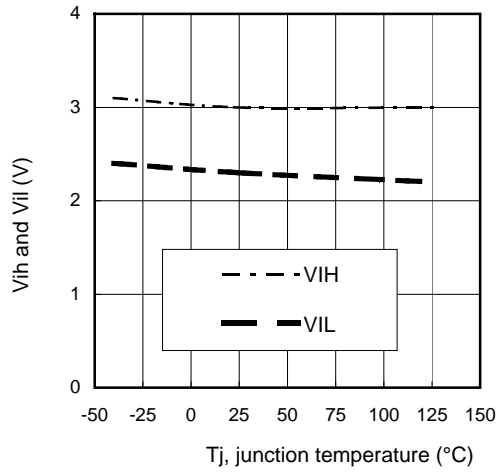

Figure 6 – Vih and Vil (V) Vs Tj (°C)

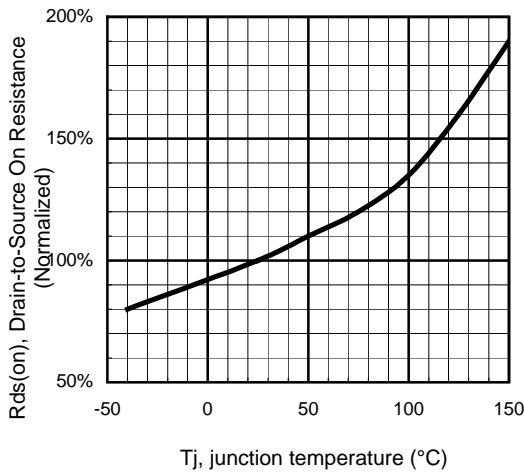

Figure 7 - Normalized Rds(on) (%) Vs Tj (°C)

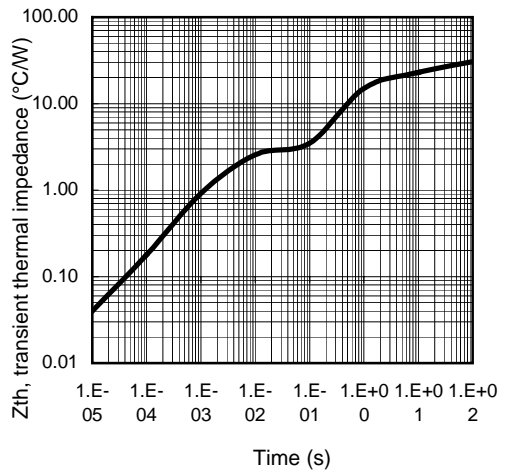

Figure 8 – Transient thermal impedance (°C/W) Vs time (s)

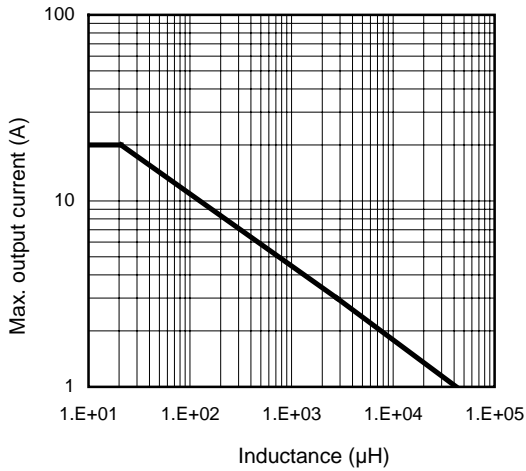

Figure 9 – Max. I_{out} (A) Vs inductance (µH)

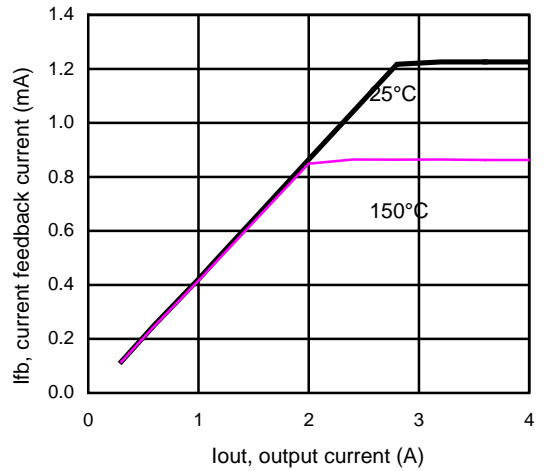
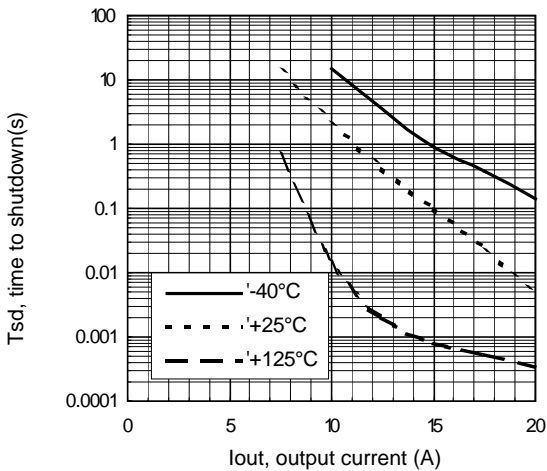
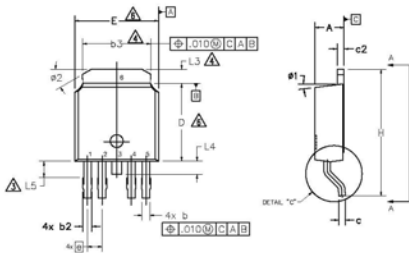
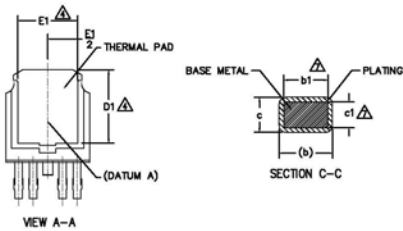
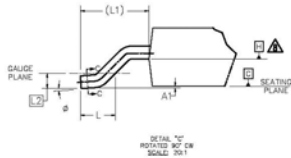

Figure 10 – I_{fb} (mA) Vs I_{out} (A)



**Figure 11 – T_{sd} (s) Vs I_{out} (A)
 SMD with 6cm²**

Case Outline 5 Lead – DPAK



SYMBOL	DIMENSIONS				NOTES
	MILLIMETERS		INCHES		
	MIN.	MAX.	MIN.	MAX.	
A	2.18	2.39	.086	.094	
A1	—	0.13	—	.005	
b	0.56	0.79	.022	.031	2
b1	.056	0.74	.022	.029	
b2	0.65	0.89	.026	.035	
b3	4.95	5.46	.195	.215	2
c	0.46	0.61	.018	.024	
c1	0.41	0.56	.016	.022	2
c2	0.46	0.89	.018	.035	
D	5.97	6.22	.235	.245	3
D1	5.21	—	.205	—	
E	6.35	6.73	.250	.265	3
E1	4.32	—	.170	—	
e	1.14 BSC		.045 BSC		
H	9.40	10.41	.370	.410	
L	1.40	1.78	.055	.070	
L1	2.74 BSC		.108 REF.		
L2	0.51 BSC		.020 BSC		
L3	0.89	1.27	.035	.050	
L4	—	1.02	—	.040	
L5	1.14	1.52	.045	.060	
ø	0"	10"	0"	10"	
ø1	0"	15"	0"	15"	
ø2	28"	32"	28"	32"	

NOTES:

- 1.- DIMENSIONING AND TOLERANCING AS PER ASME Y14.5M-1994
- 2.- DIMENSIONS ARE SHOWN IN INCHES [MILLIMETERS]
- 3.- LEAD DIMENSION UNCONTROLLED IN L5.
- 4.- DIMENSION D1, E1, L3 & b3 ESTABLISH A MINIMUM MOUNTING SURFACE FOR THERMAL PAD.
- 5.- SECTION C-C DIMENSIONS APPLY TO THE FLAT SECTION OF THE LEAD BETWEEN .005 AND 0.10 [0.13 AND 0.25] FROM THE LEAD TIP.
- 6.- DIMENSION D & E DO NOT INCLUDE MOLD FLASH. MOLD FLASH SHALL NOT EXCEED .005 [0.13] PER SIDE. THESE DIMENSIONS ARE MEASURED AT THE OUTMOST EXTREMES OF THE PLASTIC BODY.
- 7.- DIMENSION b1 & c1 APPLIED TO BASE METAL ONLY.
- 8.- DATUM A & B TO BE DETERMINED AT DATUM PLANE H.
- 9.- OUTLINE CONFORMS TO JEDEC OUTLINE TO-252.
10. LEADS AND DRAIN ARE PLATED WITH 100% Sn

Tape & Reel 5 Lead – DPAK

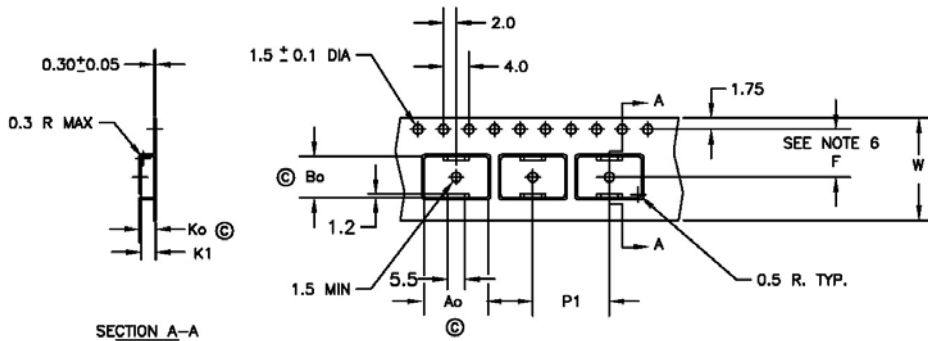

SECTION A-A

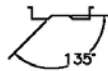

$A_o = 10.5 \text{ mm}$
 $B_o = 7.0 \text{ mm}$
 $K_o = 2.8 \text{ mm}$
 $K_1 = 2.4 \text{ mm}$
 $F = 7.5 \text{ mm}$
 $P_1 = 12.0 \text{ mm}$
 $W = 16.0 \pm .3 \text{ mm}$

NOTES:

1. 10 SPROCKET HOLE PUNCH CUMULATIVE TOLERANCE ± 0.02
2. CAMBER NOT TO EXCEED 1mm IN 100mm
3. MATERIAL: CONDUCTIVE BLACK POLYSTYRENE
4. A_o AND B_o MEASURED ON A PLANE 0.3mm ABOVE THE BOTTOM OF THE POCKET
5. K_o MEASURED FROM A PLANE ON THE INSIDE BOTTOM OF THE POCKET TO THE TOP SURFACE OF THE CARRIER
6. POCKET POSITION RELATIVE TO THE SPROCKET HOLE MEASURED AS TRUE POSITION OF POCKET, NOT POCKET HOLE
7. VENDOR: (OPTIONAL)
8. MUST ALSO MEET REQUIREMENTS OF EIA STANDARD #EIA-481A, TAPING OF SURFACE-MOUNT COMPONENTS FOR AUTOMATIC PLACEMENT.
9. TOLERANCE TO BE MANUFACTURER STANDARD
10. SURFACE RESISTIVITY OF MOLDED MATL: MUST MEASURE LESS THAN OR EQUAL TO 10^8 OHMS PER SQUARE. MEASURED IN ACCORDANCE TO PROCEDURE GIVEN IN ASTM D-257 & ASTM D-991 (REF. C-9000 SPEC.)
11. TOTAL LENGTH PER REEL MUST BE 79 METERS
12. © CRITICAL DIMENSION

Part Marking Information

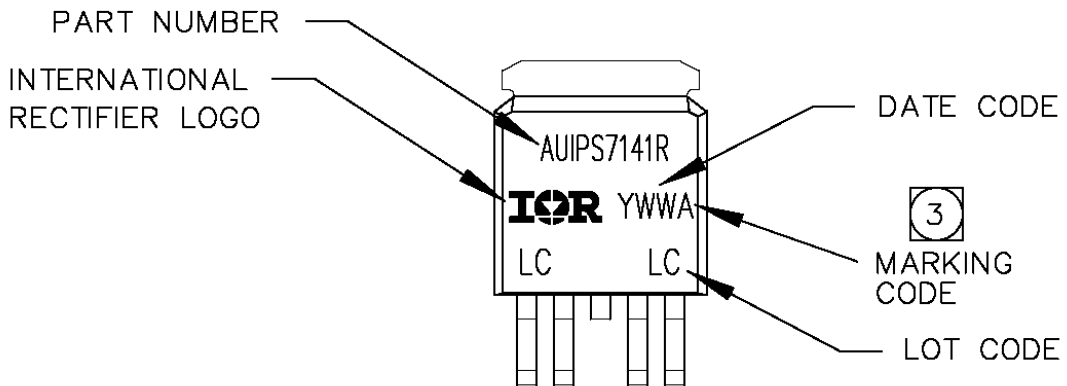

Ordering Information

Base Part Number	Package Type	Standard Pack		Complete Part Number
		Form	Quantity	
AUIPS7141R	D-Pak-5-Lead	Tube	75	AUIPS7141R
		Tape and reel	3000	AUIPS7141RTR
		Tape and reel left	2000	AUIPS7141RTRL
		Tape and reel right	2000	AUIPS7141RTRR

The information provided in this document is believed to be accurate and reliable. However, International Rectifier assumes no responsibility for the consequences of the use of this information. International Rectifier assumes no responsibility for any infringement of patents or of other rights of third parties which may result from the use of this information. No license is granted by implication or otherwise under any patent or patent rights of International Rectifier. The specifications mentioned in this document are subject to change without notice. This document supersedes and replaces all information previously supplied.

For technical support, please contact IR's Technical Assistance Center
<http://www.irf.com/technical-info/>

WORLD HEADQUARTERS:
 233 Kansas St., El Segundo, California 90245
 Tel: (310) 252-7105