

MAXIM

Low-Voltage Reference

MAX8069

General Description

The MAX8069 is a 1.2V temperature-compensated voltage reference. It uses the bandgap principle to achieve excellent stability and low noise at reverse currents down to 60 μ A. The MAX8069 also features excellent stability, freedom from oscillation. The MAX8069 is a functional alternative to Maxim's ICL8069 with an identical pinout.

Applications

Analog-to-Digital Converters
 Digital-to-Analog Converters
 Threshold Detectors
 Voltage Regulators
 Portable Instruments

Features

- ◆ Temperature Coefficient Guaranteed to 25ppm/ $^{\circ}$ C (max)
- ◆ Low Bias Current: 60 μ A (min)
- ◆ Low Dynamic Impedance
- ◆ Low Reverse Voltage
- ◆ Low Cost

Ordering Information

PART	TEMP RANGE	PIN-PACKAGE	PKG CODE
MAX8069ESA+	-40 $^{\circ}$ C to +85 $^{\circ}$ C	8 SO	S8-2
MAX8069CCZQ	0 $^{\circ}$ C to +70 $^{\circ}$ C	TO-92	C92-2

+Denotes lead-free package.

Typical Operating Circuit

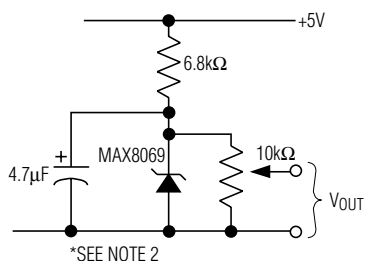

(a) Simple Reference (1.2V or Less)

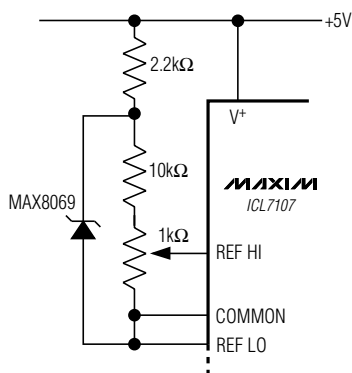

(b) Double-Regulated 100mV Reference for ICL7107 One-Chip DPM Circuit

Selector Guide

PART	TEMP RANGE	PIN-PACKAGE	MAX TEMPCO (ppm/ $^{\circ}$ C)
MAX8069ESA+	-40 $^{\circ}$ C to +85 $^{\circ}$ C	8 SO	25
MAX8069CCZQ	0 $^{\circ}$ C to +70 $^{\circ}$ C	TO-92	50

Pin Configurations

TOP VIEW

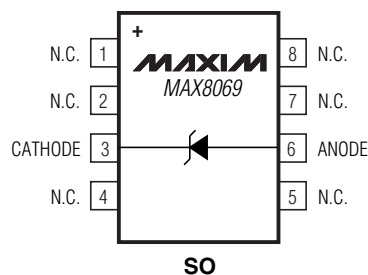

Pin Configurations continued at end of data sheet.

Low-Voltage Reference

ABSOLUTE MAXIMUM RATINGS

Reverse Voltage(Note 1)
 Forward Current 10mA
 Reverse Current 10mA
 Power Dissipation Limited by Max Forward/Reverse Current
 Storage Temperature Range -65°C to +150°C

Operating Temperature Range
 MAX8069CCZQ 0°C to +70°C
 MAX8069ESA -40°C to +85°C
 Lead Temperature (soldering, 10s) +300°C

Note 1: In normal use, the reverse voltage cannot exceed the reference voltage. However, when plugging units into a powered-up test fixture, an instantaneous voltage equal to the compliance of the test circuit will be seen. This should not exceed 20V.

Stresses beyond those listed under "Absolute Maximum Ratings" may cause permanent damage to the device. These are stress ratings only, and functional operation of the device at these or any other conditions beyond those indicated in the operational sections of the specifications is not implied. Exposure to absolute maximum rating conditions for extended periods may affect device reliability.

ELECTRICAL CHARACTERISTICS

(T_A = +25°C, unless otherwise noted.) (Note 2)

PARAMETER	CONDITIONS	MIN	TYP	MAX	UNITS
Output Voltage	I _R = 500μA	1.20	1.22	1.25	V
Output Voltage Temperature Coefficient	I _R = 500μA, T _A = T _{MIN} to T _{MAX}	MAX8069ESA		25	ppm/°C
		MAX8069CCZQ		50	
Output Voltage Change	60μA ≤ I _R ≤ 5mA		15	20	mV
Reverse Dynamic Impedance	I _R = 60μA		1	2	Ω
	I _R = 500μA		0.6	2	
Forward Voltage Drop	I _R = 500μA		0.6	1	V
RMS Noise Voltage	10Hz ≤ f ≤ 10kHz, I _R = 500μA		20		μV
Reverse Current Range		0.06		5.0	mA

Note 2: If circuit strays in excess of 200pF are anticipated, a 4.7μF shunt capacitor will ensure stability under all operating conditions.

Low-Voltage Reference

Typical Operating Characteristics

($T_A = +25^\circ\text{C}$, unless otherwise noted.)

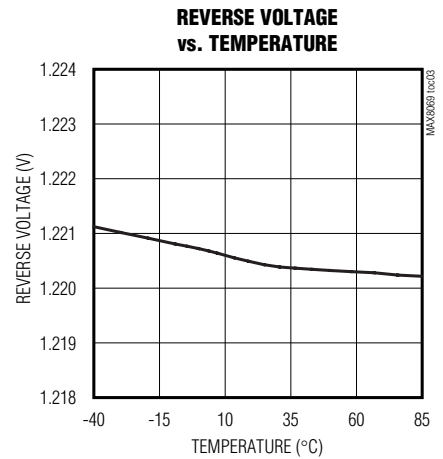
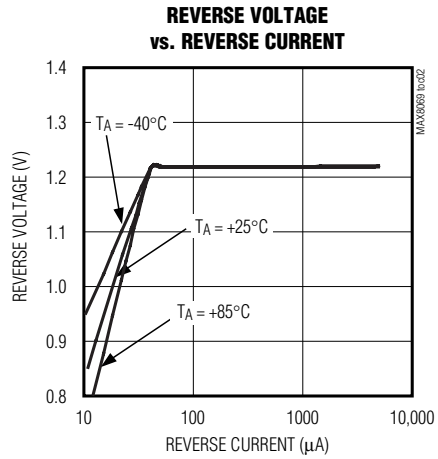
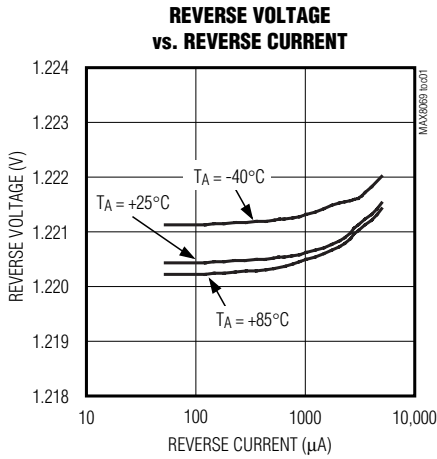

MAX8069

Pin Configurations (continued)

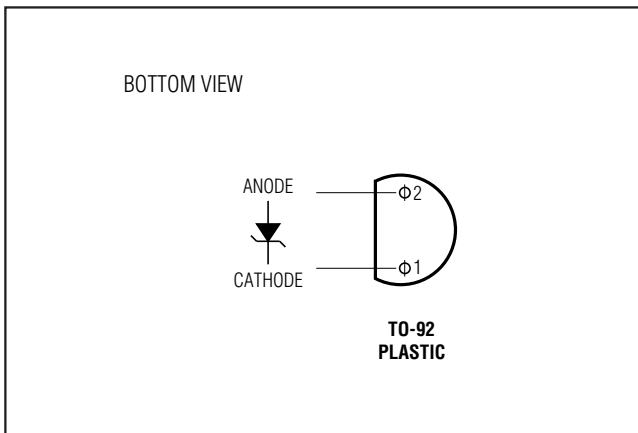

Low-Voltage Reference

Package Information

(The package drawing(s) in this data sheet may not reflect the most current specifications. For the latest package outline information, go to www.maxim-ic.com/packages.)

TOP VIEW

FRONT VIEW

SIDE VIEW

DIM	INCHES		MILLIMETERS	
	MIN	MAX	MIN	MAX
A	0.053	0.069	1.35	1.75
A1	0.004	0.010	0.10	0.25
B	0.014	0.019	0.35	0.49
C	0.007	0.010	0.19	0.25
e	0.050 BSC		1.27 BSC	
E	0.150	0.157	3.80	4.00
H	0.228	0.244	5.80	6.20
L	0.016	0.050	0.40	1.27

VARIATIONS:

DIM	INCHES		MILLIMETERS		N	MS012
	MIN	MAX	MIN	MAX		
D	0.189	0.197	4.80	5.00	8	AA
D	0.337	0.344	8.55	8.75	14	AB
D	0.386	0.394	9.80	10.00	16	AC

NOTES:

- D&E DO NOT INCLUDE MOLD FLASH.
- MOLD FLASH OR PROTRUSIONS NOT TO EXCEED 0.15mm (.006").
- LEADS TO BE COPLANAR WITHIN 0.10mm (.004").
- CONTROLLING DIMENSION: MILLIMETERS.
- MEETS JEDEC MS012.
- N = NUMBER OF PINS.

PROPRIETARY INFORMATION

TITLE: PACKAGE OUTLINE, .150" SOIC

APPROVAL	DOCUMENT CONTROL NO. 21-0041	REV. B	1/1
----------	---------------------------------	-----------	-----

Revision History

Pages changed at Rev 1: 1, 2, 4.

Maxim cannot assume responsibility for use of any circuitry other than circuitry entirely embodied in a Maxim product. No circuit patent licenses are implied. Maxim reserves the right to change the circuitry and specifications without notice at any time.

4 Maxim Integrated Products, 120 San Gabriel Drive, Sunnyvale, CA 94086 408-737-7600