

PLEASE CHECK WWW.MOLEX.COM FOR LATEST PART INFORMATION

Part Number: [0702472054](#)
Status: **Active**
Overview: [cgrid_sl_products](#)
Description: 2.54mm (.100") Pitch C-Grid® Header, Dual Row, Low Profile, Right Angle, Shrouded, 20 Circuits, 0.127µm (5µ") Gold (Au) Plating, Tin(Sn) PC TailPlating

Documents:

[3D Model](#) [Product Specification PS-70246-100 \(PDF\)](#)
[Drawing \(PDF\)](#) [RoHS Certificate of Compliance \(PDF\)](#)
[Product Specification PS-70246 \(PDF\)](#)

Agency Certification

CSA LR19980
 UL E29179

General

Product Family PCB Headers
 Series [70247](#)
 Application Wire-to-Board
 Overview [cgrid_sl_products](#)
 Product Name C-Grid®

Physical

Breakaway No
 Circuits (Loaded) 20
 Circuits (maximum) 20
 Color - Resin Black
 Durability (mating cycles max) 50
 First Mate / Last Break No
 Flammability 94V-0
 Glow-Wire Compliant No
 Guide to Mating Part No
 Keying to Mating Part None
 Lock to Mating Part None
 Material - Plating Mating Gold
 Material - Plating Termination Tin
 Material - Resin Polyester
 Number of Rows 2
 Orientation Right Angle
 PC Tail Length (in) 0.100 In
 PC Tail Length (mm) 2.54 mm
 PCB Locator No
 Packaging Type Tray
 Pitch - Mating Interface (in) 0.100 In
 Pitch - Mating Interface (mm) 2.54 mm
 Pitch - Term. Interface (in) 0.100 In
 Pitch - Term. Interface (mm) 2.54 mm
 Plating min: Mating (µin) 5.2
 Plating min: Mating (µm) 0.13
 Plating min: Termination (µin) 75.2
 Plating min: Termination (µm) 1.88
 Polarized to Mating Part Yes
 Polarized to PCB No
 Shrouded Closed Ends
 Stackable No
 Surface Mount Compatible (SMC) No

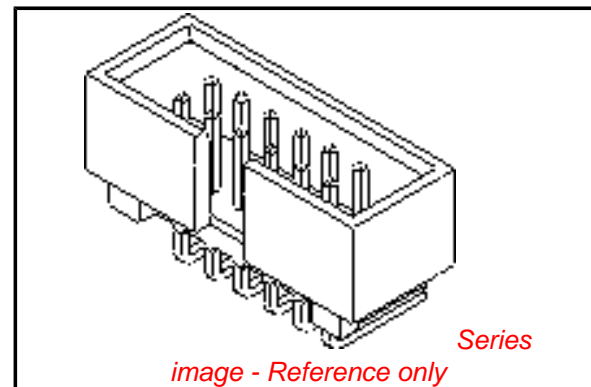

EU RoHS

**ELV and RoHS
 Compliant**
**REACH SVHC
 Contains SVHC: No
 Halogen-Free
 Status**

China RoHS



**Need more information on product
 environmental compliance?**

Email productcompliance@molex.com
 For a multiple part number RoHS Certificate of
 Compliance, [click here](#)

Please visit the [Contact Us](#) section for any
 non-product compliance questions.

Search Parts in this Series

[70247Series](#)

Mates With

[70450 SL™](#) Crimp Housing, [70058 SL™](#)
 Crimp Terminal

Temperature Range - Operating -55°C to +120°C
Termination Interface: Style Through Hole

Electrical

Current - Maximum per Contact 2.5A
Voltage - Maximum 250V DC

Solder Process Data

Duration at Max. Process Temperature (seconds) 10
Lead-free Process Capability Wave Capable (TH only)
Max. Cycles at Max. Process Temperature 1
Process Temperature max. C 265

Material Info

Reference - Drawing Numbers

Packaging Specification PK-87835-001
Product Specification PS-70246, PS-70246-100
Sales Drawing SDA-70247-**-00-04

This document was generated on 05/24/2010

PLEASE CHECK WWW.MOLEX.COM FOR LATEST PART INFORMATION

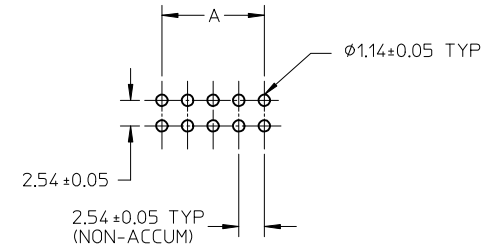
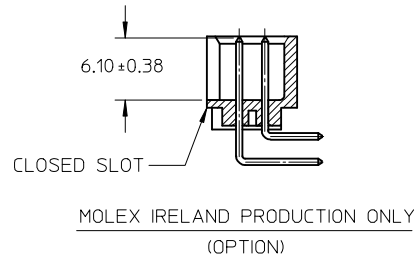
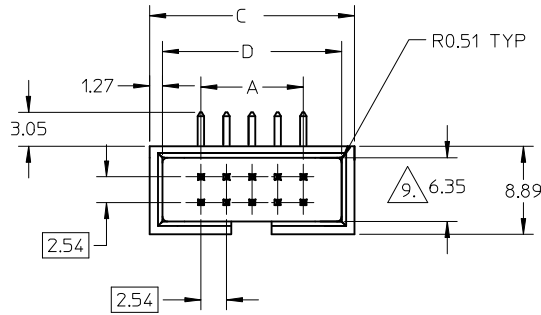

RECOMMENDED PCB HOLE LAYOUT

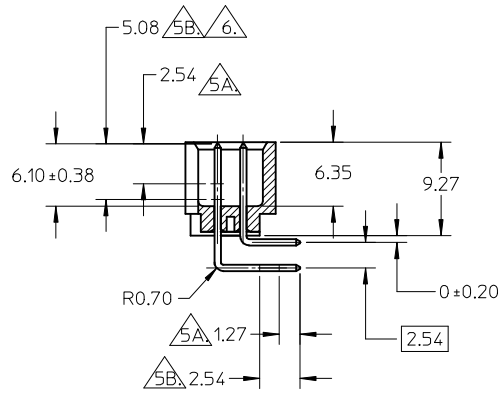
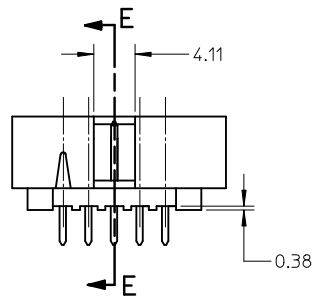

SECTION E-E

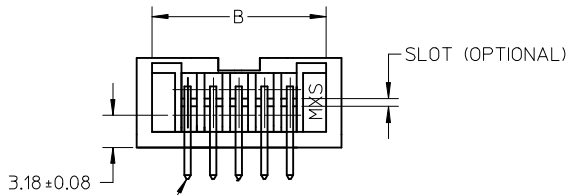

AT TIPS BOTH ENDS

LEGEND:



70247 - * * * *
 CKT SIZE
 PLATING OPT.



REVISE DIMENSIONS EC NO: S2010-0369 DRWN:SKANG 2009/10/27 CHKD:ATSEE 2009/11/09 APPR:MLONG 2009/11/11	QUALITY SYMBOLS $F_A=0$ $F_C=0$ $F_P=0$	GENERAL TOLERANCES (UNLESS SPECIFIED) mm INCH 4 PLACES ± --- ± --- 3 PLACES ± --- ± --- 2 PLACES ± 0.20 ± --- 1 PLACE ± --- ± --- ANGULAR ± 3 °	DIMENSION STYLE MM ONLY DRAWN BY JENNIFER DATE 1987/09/21 CHECKED BY MLAI DATE 1987/09/21 APPROVED BY MLONG DATE 2009/11/10	SCALE NTS DESIGN UNITS METRIC THIRD ANGLE PROJECTION	TITLE C-GRID, SHROUDED HEADER R/A (SLOTTED W/O STANDOFFS) MOLEX INCORPORATED	
	DRAFT WHERE APPLICABLE MUST REMAIN WITHIN DIMENSIONS	MATERIAL NO. SEE TABLE SIZE A3	DOCUMENT NO. SDA-70247-**-00-04 SHEET NO. 1 OF 2	THIS DRAWING CONTAINS INFORMATION THAT IS PROPRIETARY TO MOLEX INCORPORATED AND SHOULD NOT BE USED WITHOUT WRITTEN PERMISSION		
	H3	REV	DESCRIPTION	MOLEX INCORPORATED		
				MOLEX INCORPORATED		

NOTES:





1. PIN PUSHOUT FORCE (.9072KG)/2LBS MIN.
2. PIN SOLDERABILITY PER MOLEX SPEC. ES-152.
3. PRODUCT SPEC: PS-70246 APPLIES.
4. WAFER TO BE FLAT WITHIN .003 MM/MM.
5. DIMENSIONS FOR PLATING LOCATION:

 MEASURE POINT FOR THICKNESS
 MINIMUM COVERAGE

-  GOLD END OF PIN UNLESS OVERALL PLATED.
-  FINISH: - 51 : 15 MICRO INCHES MIN GOLD PLATE ON CONTACT AND 75 MICRO INCHES MIN TIN PLATE ON SOLDERTAIL BOTH OVER 50 MICRO INCHES MIN NICKEL OVERALL.
 - 52 : 30 MICRO INCHES MIN GOLD PLATE ON CONTACT AND 75 MICRO INCHES MIN TIN PLATE ON SOLDERTAIL BOTH OVER 50 MICRO INCHES MIN NICKEL OVERALL.
 - 54 : 5 MICRO INCHES MIN GOLD PLATE ON CONTACT AND 75 MICRO INCHES MIN TIN PLATE ON SOLDERTAIL BOTH OVER 50 MICRO INCHES MIN NICKEL OVERALL.

-  CHECK WITH SALES OFFICE FOR AVAILABILITY.
-  DIM AT THE CENTRE OF THE SHROUDED WALL SHALL BE 5.91MM MIN. THIS SPEC IS VALID FOR ALL CKT SIZE.
10. MATERIAL:
 HSG: PBT, GLASS FILLED, UL94V-0, COLOUR: BLACK (SPEC NO: 89992-0028)
 PIN: 0.64MM SQ. PIN PHOSPHOR BRONZE.
-  SOLDERTAIL POSITION TOLERANCE TO BE GAUGED.

PART NUMBER 	CKT SIZE	DIM A	DIM B	DIM C	DIM D
70247-08**	08	7.62	14.73	17.78	15.24
70247-10**	10	10.16	17.27	20.32	17.78
70247-12**	12	12.70	19.81	22.86	20.32
70247-14**	14	15.24	22.35	25.40	22.86
70247-16**	16	17.78	24.89	27.94	25.40
70247-20**	20	22.86	29.97	33.02	30.48
70247-24**	24	27.94	35.05	38.10	35.56
70247-26**	26	30.48	37.59	40.64	38.10
70247-30**	30	35.56	42.67	45.72	43.18
70247-34**	34	40.64	47.75	50.80	48.26
70247-40**	40	48.26	55.37	58.42	55.88
70247-44**	44	53.34	60.45	63.50	60.96
70247-48**	48	58.42	65.53	68.58	66.04
70247-50**	50	60.96	68.07	71.12	68.58
70247-56**	56	68.58	75.69	78.74	76.20
70247-60**	60	73.66	80.77	83.82	81.28
70247-64**	64	78.74	85.85	88.90	86.36
70247-72**	72	88.90	96.01	99.06	96.52

REVISE DIMENSIONS EC NO: S2010-0369 2009/10/27 DRWN:SKANG CHYKD:ATSEE 2009/11/09 APPR:MLONG 2009/11/11	QUALITY SYMBOLS	GENERAL TOLERANCES (UNLESS SPECIFIED)		DIMENSION STYLE MM ONLY		SCALE NTS	DESIGN UNITS METRIC	THIRD ANGLE PROJECTION		
	 =0	4 PLACES	mm	INCH	DRAWN BY JENNIFER	DATE 1987/09/21	TITLE C-GRID, SHROUDED HEADER R/A (SLOTTED W/O STANDOFFS)			
	 =0	3 PLACES	± ---	± ---	CHECKED BY MLA1	DATE 1987/09/21				
	 =0	2 PLACES	± 0.20	± ---	APPROVED BY MLONG	DATE 2009/11/10	 MOLEX INCORPORATED MATERIAL NO. SEE TABLE DOCUMENT NO. SDA-70247-**-00-04 SHEET NO. 2 OF 2			
	1 PLACE	± ---	± ---	DRAFT WHERE APPLICABLE MUST REMAIN WITHIN DIMENSIONS		SIZE A3				