

15A Non-Isolated DC/DC Converter in SIP configuration

The NiQor™ SIP DC/DC converter is a non-isolated buck regulator, which employs synchronous rectification to achieve extremely high conversion efficiency. The NiQor family of converters are used predominately in DPA systems using a front end DC/DC high power brick (48V_{in} to low voltage bus). The non-isolated NiQor converters are then used at the point of load to create the low voltage outputs required by the design. Typical applications include telecom/datacom, industrial, medical, transportation, data processing/storage and test equipment.

NiQor
Non-Isolated



NiQor vertical mount SIP module

Operational Features

- Ultra-high efficiency, up to 93% full load, 95% half
- Delivers 15 amps of output current with minimal derating - no heatsink required
- Input voltage range: 3.0 - 3.6V
- Fixed frequency switching provides predictable EMI performance
- Fast transient response time
- On-board input and output filter capacitor
- No minimum load requirement means no preload resistors required

Protection Features

- Input under-voltage lockout disables converter at low input voltage conditions
- Temperature compensated over-current shutdown protects converter from excessive load current or short circuits
- Output over-voltage protection protects load from damaging voltages
- Thermal shutdown

Mechanical Features

- Industry standard SIP pin-out configuration
- Industry standard size: 2.0" x 0.55" x 0.29 (50.8 x 14 x 7.3mm)
- Total weight: 0.30 oz. (9.4 g), lower mass greatly reduces vibration and shock problems
- Open frame construction maximizes air flow cooling
- Available in both vertical and horizontal mounting

Control Features

- On/Off control
- Output voltage trim (industry standard) permits custom voltages and voltage margining
- Optional features include remote sense and wide output voltage trim (0.85V - 2.75V)

Safety Features

- UL 1950 recognized (US & Canada)
- TUV certified to EN60950
- Meets 72/23/EEC and 93/68/EEC directives which facilitates CE Marking in user's end product
- Board and plastic components meet UL94V-0 flammability requirements

MECHANICAL DIAGRAM

Vertical Mount

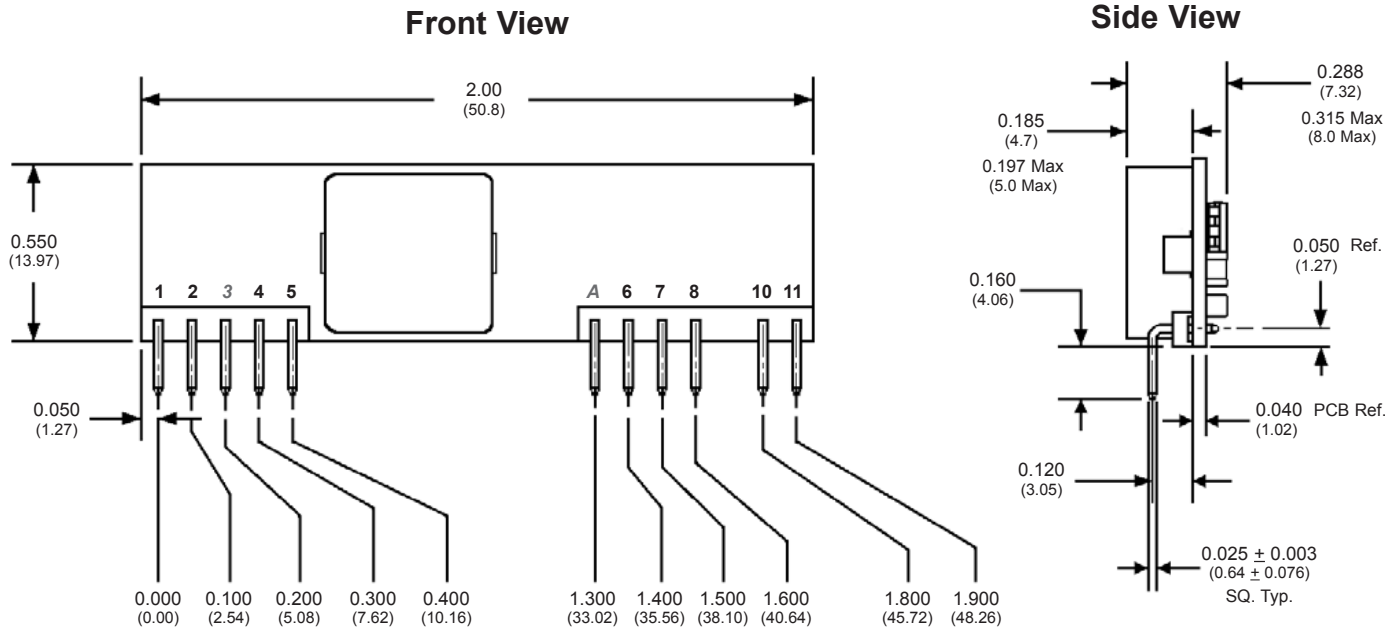

NOTES

- 1) All pins are 0.025" (0.64mm) +/- 0.003 (0.076mm) square.
- 2) All Pins: Material - Copper Alloy
Finish - Tin over Nickel plate
- 3) Vertical, horizontal, vertical with reverse pins and surface mount options (future) available.
- 4) Undimensioned components are shown for visual reference only.
- 6) All dimensions in inches (mm)
Tolerances: x.xx +/-0.02 in. (x.x +/-0.5mm)
x.xxx +/-0.010 in. (x.xx +/-0.25mm)
- 7) Weight: 0.30 oz. (9.4 g) typical
- 8) Workmanship: Meets or exceeds IPC-A-610C Class II

Pin Connection Notes:

1. Pin 10 - for fixed resistors, connect between Trim and Vout(+) to trim down or between Trim and Common (Ground) to trim up.
2. Pin 11 - see section on Remote ON/OFF pin for description of enable logic options.

PIN DESIGNATIONS

| Pin No. | Name | Function |
|---------|-----------------|---|
| 1 | Vout(+) | Positive output voltage |
| 2 | Vout(+) | Positive output voltage |
| 3 | <i>SENSE(+)</i> | <i>Positive remote sense</i> |
| 4 | Vout(+) | Positive output voltage |
| 5 | Common | |
| A | <i>I share</i> | <i>Current share*</i> |
| 6 | Common | |
| 7 | Vin(+) | Positive input voltage |
| 8 | Vin(+) | Positive input voltage ¹ |
| 10 | TRIM | Output voltage trim ² |
| 11 | ON/OFF | LOGIC input to turn the converter on and off. |

Pins in Italics Shaded text are Optional

* Contact factory for availability of current share modules.

MECHANICAL DIAGRAM

Horizontal Mount

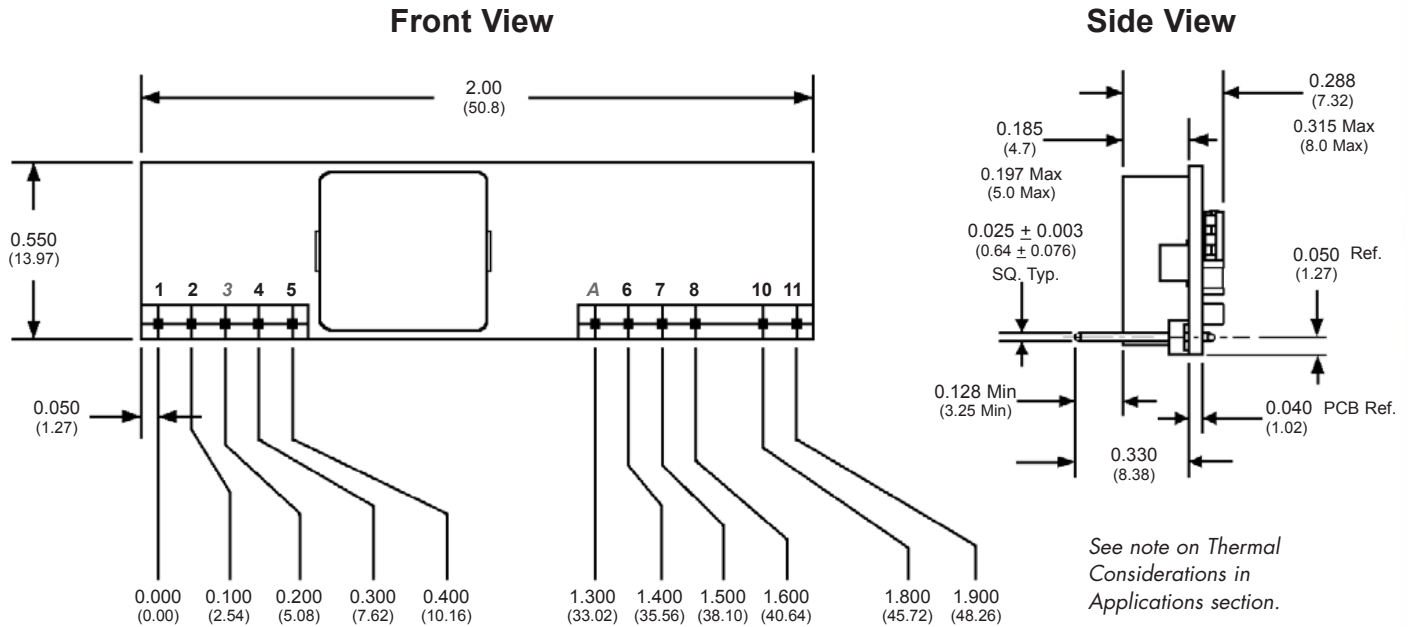

Vertical Mount Reversed Pins

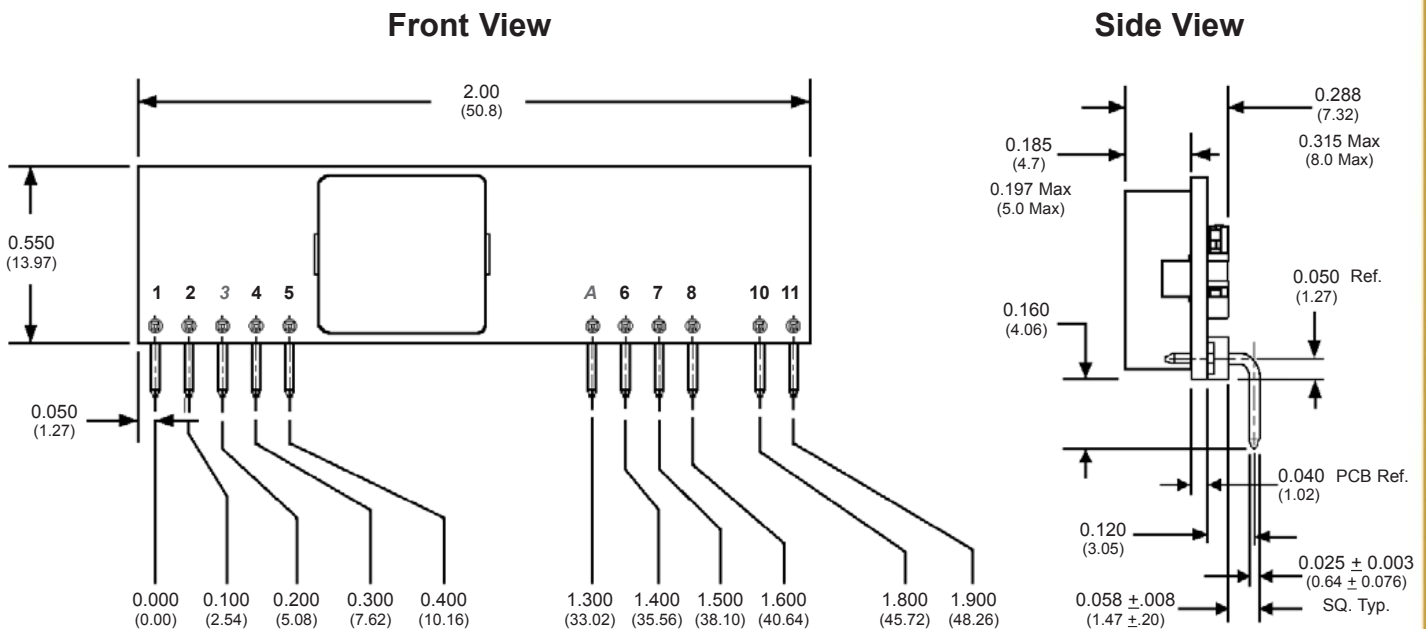



Technical Specification

**Non-Isolated
SIP Converter**

3.0 - 3.6V_{in} 15A

ELECTRICAL CHARACTERISTICS - NQ03xxxVMA15 Series

T_A=25°C, airflow rate=300 LFM, V_{in}=3.3Vdc unless otherwise noted; full operating temperature range is -40°C to +105°C ambient temperature with appropriate power derating. Specifications subject to change without notice.

| Parameter | Module | Min. | Typ. | Max. | Units | Notes & Conditions |
|---|----------|-------|-------|-------|------------------|--|
| ABSOLUTE MAXIMUM RATINGS | | | | | | |
| Input Voltage | | | | | | |
| Non-Operating | All | | | 5.0 | V | continuous |
| Operating | All | 3.0 | | 4.5 | V | continuous |
| Operating Transient Protection | All | | | 5.0 | V | 100ms transient |
| Operating Temperature | All | -40 | | 105 | °C | |
| Storage Temperature | All | -55 | | 125 | °C | |
| Voltage at ON/OFF input pin | All | -3 | | 6.5 | V | |
| INPUT CHARACTERISTICS | | | | | | |
| Operating Input Voltage Range ¹ | All | 3.0 | | 3.6 | V | Notes on pg. 6 |
| Input Under-Voltage Lockout | | | | | | |
| Turn-On Voltage Threshold | All | 2.1 | 2.4 | 2.8 | V | |
| Turn-Off Voltage Threshold | All | 2.0 | 2.3 | 2.5 | V | |
| Maximum Input Current ² | 0.9V | | | 5.9 | A | 100% Load, 3.0V _{in} , 0.9V _{out} |
| | 1.2V | | | 7.4 | A | 100% Load, 3.0V _{in} , 1.2V _{out} |
| | 1.5V | | | 8.9 | A | 100% Load, 3.0V _{in} , 1.5V _{out} |
| | 1.8V | | | 10.4 | A | 100% Load, 3.0V _{in} , 1.8V _{out} |
| | 2.5V | | | 13.9 | A | 100% Load, 3.0V _{in} , 2.5V _{out} |
| No-Load Input Current | All | | 85 | 110 | mA | |
| Disabled Input Current | All | | 17 | 25 | mA | |
| Inrush Current Transient Rating | All | | 0.1 | | A ² s | |
| Response to Input Transient | 0.9V | | 70 | | mV/V | 50mV/μs input transient (all) |
| | 1.2V | | 80 | | mV/V | |
| | 1.5V | | 90 | | mV/V | |
| | 1.8V | | 120 | | mV/V | |
| | 2.5V | | 160 | | mV/V | |
| Input Reflected-Ripple Current | 0.9-1.8V | | 200 | | mA | pk-pk thru 1μH inductor, with 200μF tantalum; full load; Figs 24, 26 |
| | 2.5V | | 125 | | mA | |
| Input Terminal Ripple Current | 0.9-1.8V | | 3 | | A | RMS with 200μF tantalum and 1μH; Figs 24, 26 |
| | 2.5V | | 2 | | A | |
| Recommended Input Fuse | All | | | 20 | A | fast blow external fuse recommended |
| Input Filter Capacitor Value | All | | 40 | | μF | internal ceramic |
| Recommended External Input Capacitance ³ | All | | 200 | | μF | net 50mΩ |
| OUTPUT CHARACTERISTICS | | | | | | |
| Output Voltage Set Point ⁷ (50% load) | 0.9V | 0.885 | 0.900 | 0.917 | V | also applies to wide-trim (0.85-2.75V) unit |
| | 1.2V | 1.180 | 1.200 | 1.223 | V | |
| | 1.5V | 1.475 | 1.500 | 1.529 | V | |
| | 1.8V | 1.769 | 1.800 | 1.834 | V | |
| | 2.5V | 2.458 | 2.500 | 2.548 | V | |
| Output Voltage Regulation | | | | | | |
| Over Line | All | | ±0.1 | | % | with sense pin |
| Over Load | 0.9V | | ±0.5 | | % | |
| | 2.5V | | ±0.3 | | % | |
| Over Temperature | All | | ±2.0 | | % | |
| Total Output Voltage Range | 0.9V | 0.865 | | 0.944 | V | with sense pin, over sample, line, load, temperature & life (all) |
| | 1.2V | 1.153 | | 1.258 | V | |
| | 1.5V | 1.441 | | 1.573 | V | |
| | 1.8V | 1.729 | | 1.888 | V | |
| | 2.5V | 2.402 | | 2.622 | V | |

ELECTRICAL CHARACTERISTICS (continued) - NQ03xxxVMA15 Series

| Parameter | Module | Min. | Typ. | Max. | Units | Notes & Conditions |
|--|----------|------|-----------------|-------|----------------------|---|
| OUTPUT CHARACTERISTICS (cont.) | | | | | | |
| Output Voltage Ripple and Noise | | | | | | 20MHz bandwidth; Fig 24, 27 |
| Peak-to-Peak | All | | 15 | 35 | mV | Full Load |
| RMS | All | | 6 | 12 | mV | Full Load |
| Operating Output Current Range | All | 0 | | 15 | A | |
| Output DC Over-Current Shutdown ⁴ | All | 16 | 25 | 40 | A | |
| Maximum Output Capacitance ^{5,6} | All | | | 4,000 | µF | Derate startup load current per Fig. 23 |
| DYNAMIC CHARACTERISTICS | | | | | | |
| Input Voltage Ripple Rejection | 0.9V | | 45 | | dB | 120 Hz; Figure 31 |
| | 2.5V | | 37 | | dB | |
| Output Voltage during Load Current Transient | | | | | | |
| For a Step Change in Output Current (0.1A/µs) | All | | 40 | | mV | 50%-75%-50% I _{out} max, 10µF, Fig 15-16 |
| For a Step Change in Output Current (5A/µs) | All | | 70 | | mV | 50%-75%-50% I _{out} max, 470µF, Fig 17-18 |
| Settling Time | All | | 50 | | µs | to within 1.5% V _{out} nom., Fig 15-18 |
| Turn-On Transient | | | | | | Load current & capacitance per Fig. 23 |
| Turn-On Time | All | 5.5 | 6.8 | 8.5 | ms | Enable to V _{out} =100% nom., Figs 19-20 |
| Start-Up Delay Time | 0.9V | 2.9 | 4.1 | 6.1 | ms | Enable to 10%, Fig. 21 |
| | 2.5V | 1.6 | 2.7 | 4.6 | ms | |
| Start-Up Rise Time | 0.9V | 1.6 | 2.4 | 3.9 | ms | 10% to 90%, Fig. 22 |
| | 2.5V | 2.5 | 3.7 | 5.6 | ms | |
| Output Voltage Overshoot | All | | | 0 | % | Resistive load up to 4,000µF |
| EFFICIENCY | | | | | | |
| 100% Load | 0.9V | | 83.5 | | % | Figures 1-4 |
| | 1.2V | | 87 | | % | |
| | 1.5V | | 89 | | % | |
| | 1.8V | | 90.5 | | % | |
| | 2.5V | | 93 | | % | |
| 50% Load | 0.9V | | 88 | | % | Figures 1-4 |
| | 1.2V | | 90.5 | | % | |
| | 1.5V | | 92 | | % | |
| | 1.8V | | 93 | | % | |
| | 2.5V | | 95 | | % | |
| TEMP. LIMITS FOR POWER DERATING | | | | | | |
| Semiconductor Junction Temperature ⁷ | All | | | 125 | °C | Package rated to 150°C; Figs 5-14 |
| Board Temperature ⁷ | All | | | 125 | °C | UL rated max operating temp 130°C |
| FEATURE CHARACTERISTICS | | | | | | |
| Switching Frequency | All | 265 | 300 | 330 | kHz | may decrease by up to 30 kHz at -40°C |
| ON/OFF Control | | | | | | Figure A |
| Off-State Voltage | All | 1.5 | | 6.5 | V | |
| On-State Voltage | All | -3 | | 0.6 | V | |
| Pull-Up Voltage | All | | V _{in} | | V | |
| Output Voltage Trim Range ^{1,8} | 0.9V | -5 | | +10 | % | Measured V _{out+} to common pins; Table 1 |
| | 1.2-2.5V | -10 | | +10 | % | |
| Output Voltage Remote Sense Range ^{1,9} | All | | | +10 | % | Measured V _{out+} to common pins |
| Output Over-Voltage Protection ¹⁰ | All | 113 | 130 | 145 | % | Over full temp range; % of nominal V _{out} |
| Over-Temperature Shutdown | All | | 120 | | °C | Average PCB Temperature |
| Over-Temperature Shutdown Restart Hysteresis | All | | 5 | | °C | |
| RELIABILITY CHARACTERISTICS | | | | | | |
| Calculated MTBF (Telcordia) | All | | TBD | | 10 ⁶ Hrs. | TR-NWT-000332; 100% load, 200LFM, 40°C T _a |
| Calculated MTBF (MIL-217) | All | | 8.0 | | 10 ⁶ Hrs. | MIL-HDBK-217F; 100% load, 200LFM, 40°C T _a |
| Field Demonstrated MTBF | All | | | | 10 ⁶ Hrs. | See website for latest values |

ELECTRICAL CHARACTERISTICS (continued) - NQ03xxxVMA15 Series

NOTES

- Note 1:** Maintain a minimum of 0.35V headroom between input and output voltage to meet performance specifications.
- Note 2:** Wide trim option unit will perform as the model with the output voltage that it is trimmed to. Applies to all specifications where values differ by V_{out}.
- Note 3:** Tantalum or similar with additional ceramic as needed to reduce ripple current in external capacitors. See Figure 21. Output capacitance of $\leq 1000\mu\text{F}$. Additional input capacitance equal to half of the output capacitance is recommended when more than 1000 μF of output capacitance is used. Consult factory for more demanding applications. Also refer to Application Considerations section of this datasheet.
- Note 4:** The over-current shutdown threshold for a short over-current pulse can be as high as 50A when trimming up a wide trim unit above 1.2V.
- Note 5:** Larger input capacitance of at least half of the output capacitance is recommended when using $>1000\mu\text{F}$ on a 2.5V output.
- Note 6:** When trimming the output voltage to less than 0.88V with more than 1000 μF of output capacitance, consult factory for trim circuit recommendations.
- Note 7:** Power derating curves are measured using an evaluation board consisting of 6 layers of 2 ounce copper.
- Note 8:** Wide trim option unit has a setpoint of 0.9V and a trim range of 0.85V-2.75V.
- Note 9:** In remote sense applications, when trimming down, the trim-down resistor should be connected to the sense pin for more accurate trimming results.
- Note 10:** Indicates worst case specification for 0.9V unit. Higher output voltage units have a tighter specification range. The wide-trim unit carries the OVP set point of a 2.5V_{out} unit, which has a worst-case maximum OVP trip level of 135%.

STANDARDS COMPLIANCE

| Parameter | Notes |
|---------------------------------|---|
| STANDARDS COMPLIANCE | |
| UL/cUL 60950 | File # E194341 |
| EN60950 | Certified by TUV |
| 72/23/EEC | |
| 93/68/EEC | |
| Needle Flame Test (IEC 695-2-2) | test on entire assembly; board & plastic components UL94V-0 compliant |
| IEC 61000-4-2 | ESD test, 8kV - NP, 15kV air - NP (Normal Performance) |
| GR-1089-CORE | Section 7 - electrical safety, Section 9 - bonding/grounding |
| Telcordia (Bellcore) GR-513 | |

- An external input fuse must always be used to meet these safety requirements. Contact SynQor for official safety certificates on new releases or download from the SynQor website.

QUALIFICATION TESTING

| Parameter | # Units | Test Conditions |
|------------------------------|---------|--|
| QUALIFICATION TESTING | | |
| Life Test | 32 | 95% rated V _{in} and load, units at derating point, 1000 hours |
| Vibration | 5 | 10-55Hz sweep, 0.060" total excursion, 1 min./sweep, 120 sweeps for 3 axis |
| Mechanical Shock | 5 | 100g minimum, 2 drops in x and y axis, 1 drop in z axis |
| Temperature Cycling | 10 | -40°C to 100°C, unit temp. ramp 15°C/min., 500 cycles |
| Power/Thermal Cycling | 5 | T _{operating} = min to max, V _{in} = min to max, full load, 100 cycles |
| Design Marginality | 5 | T _{min} -10°C to T _{max} +10°C, 5°C steps, V _{in} = min to max, 0-105% load |
| Humidity | 5 | 85°C, 85% RH, 1000 hours, continuous V _{in} applied except 5min./day |
| Solderability | 15 pins | MIL-STD-883, method 2003 |

- Extensive characterization testing of all SynQor products and manufacturing processes is performed to ensure that we supply robust, reliable product. Contact factory for official product family qualification document.

OPTIONS

SynQor provides various options for Packaging, Enable Logic, Pin Length and Feature Set for this family of DC/DC converters. Please consult the last page of this specification sheet for information on available options.

PATENTS

SynQor is protected under various patents, including but not limited to U.S. Patent numbers: 5,999,417; 6,222,742 B1; 6,594,159 B2; 6,545,890 B2.

Performance Curves

Non-Isolated
SIP Converter

3.0 - 3.6V_{in} 15A

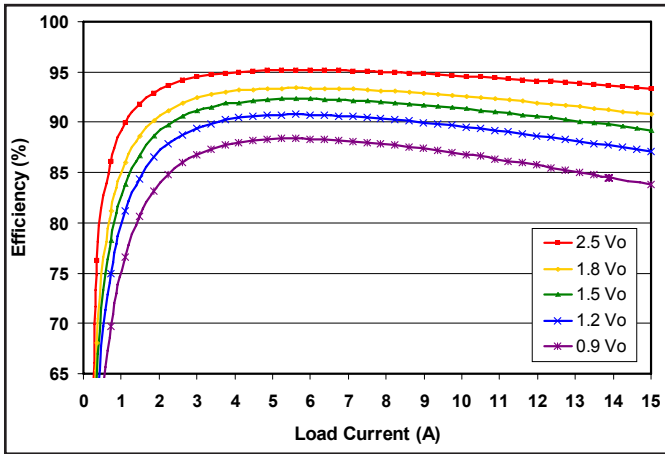

Figure 1: Efficiency at nominal output voltage vs. load current for all modules at 25°C and nominal input voltage.

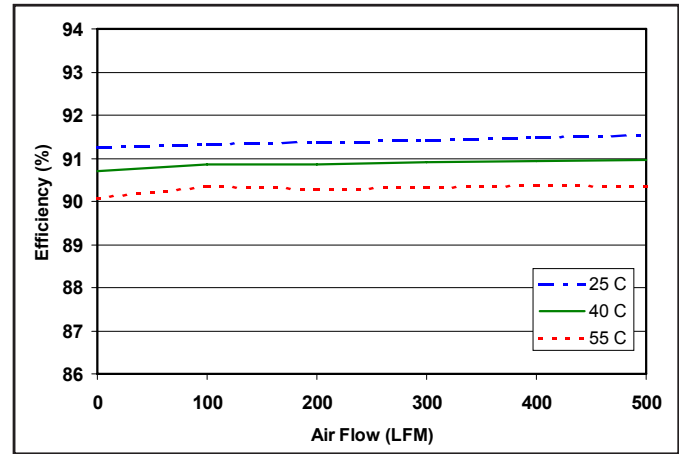

Figure 2: Efficiency at 1.5V_{out} and 60% rated power vs. airflow rate for ambient air temperatures of 25°C, 40°C, and 55°C (nominal input voltage).

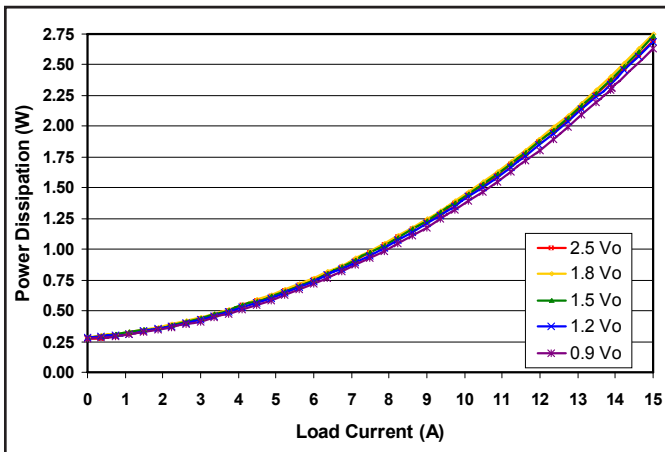

Figure 3: Power dissipation at nominal output voltage vs. load current for all modules at 25°C and nominal input voltage.

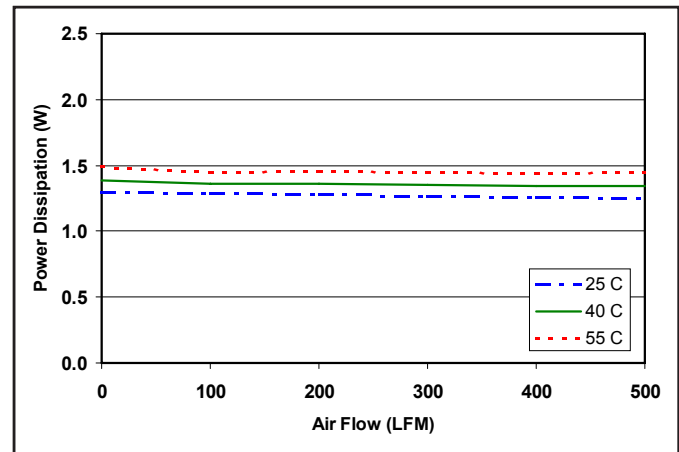

Figure 4: Power dissipation at 1.5V_{out} and 60% rated power vs. airflow rate for ambient air temperatures of 25°C, 40°C, and 55°C (nominal input voltage).

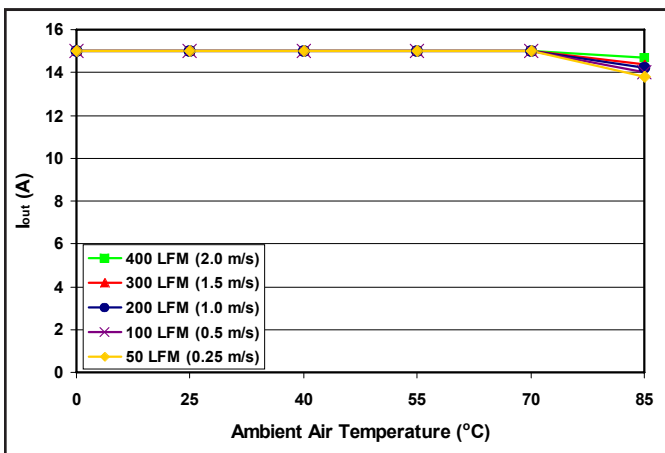

Figure 5: Maximum output power derating curves vs. ambient air temperature for 0.9V_{out} unit. Airflow rates of 50 LFM - 400 LFM with air flowing across the converter from pin 11 to pin 1 (V_{in} nom, vert mount).

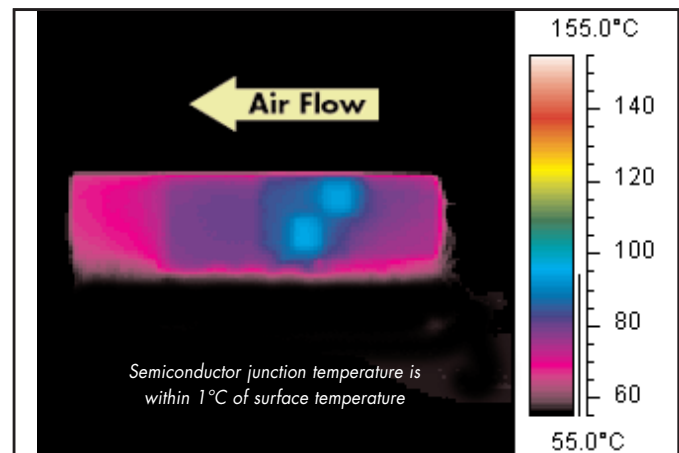

Figure 6: Thermal plot of 0.9V converter at 15 amp load current with 55°C air flowing at the rate of 200 LFM. Air is flowing across the converter sideways from pin 11 to pin 1 (V_{in} nom, vert mount).

Performance Curves

Non-Isolated
SIP Converter

3.0 - 3.6V_{in} 15A

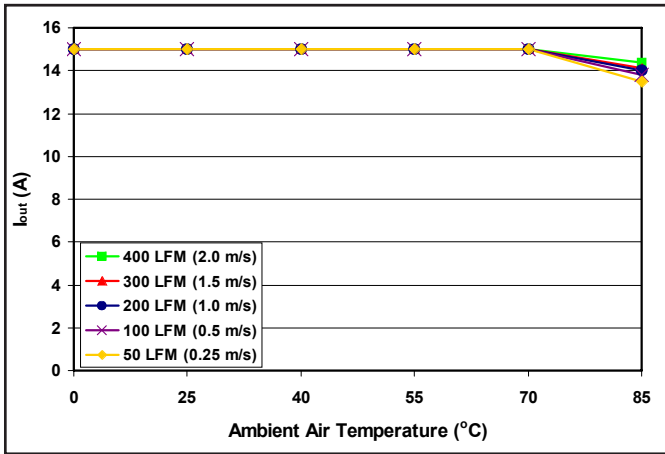

Figure 7: Maximum output power derating curves vs. ambient air temperature for 1.2V_{out} unit. Airflow rates of 50 LFM - 400 LFM with air flowing across the converter from pin 11 to pin 1 (V_{in} nom, vert mount).

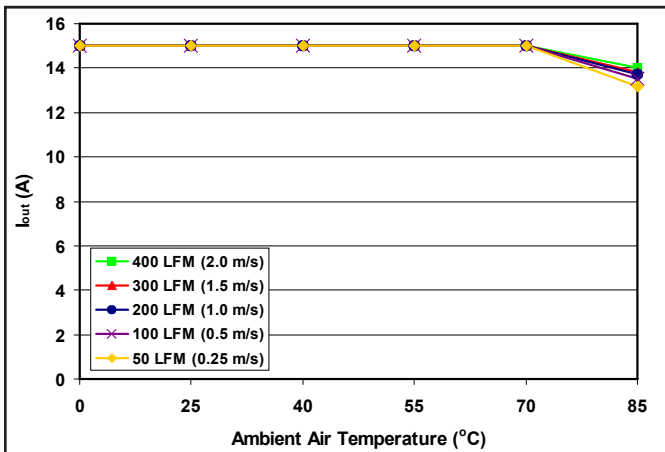

Figure 9: Maximum output power derating curves vs. ambient air temperature for 1.5V_{out} unit. Airflow rates of 50 LFM - 400 LFM with air flowing across the converter from pin 11 to pin 1 (V_{in} nom, vert mount).

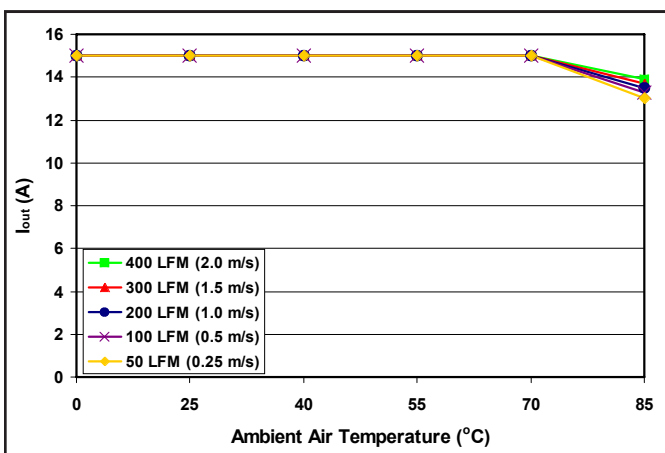

Figure 11: Maximum output power derating curves vs. ambient air temperature for 1.8V_{out} unit. Airflow rates of 50 LFM - 400 LFM with air flowing across the converter from pin 11 to pin 1 (V_{in} nom, vert mount).

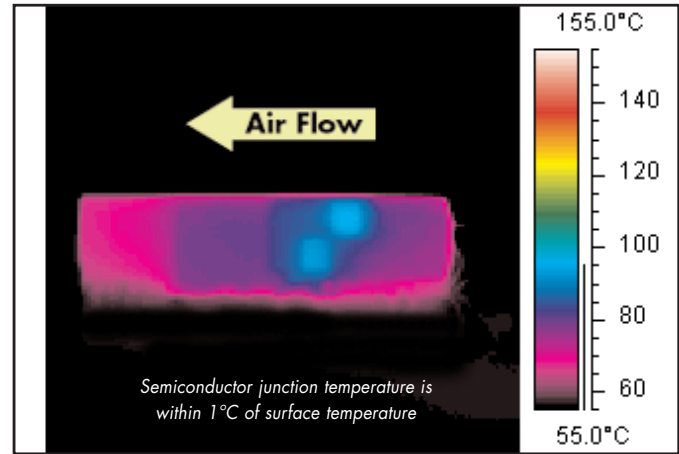

Figure 8: Thermal plot of 1.2V converter at 15 amp load current with 55°C air flowing at the rate of 200 LFM. Air is flowing across the converter sideways from pin 11 to pin 1 (V_{in} nom, vert mount).

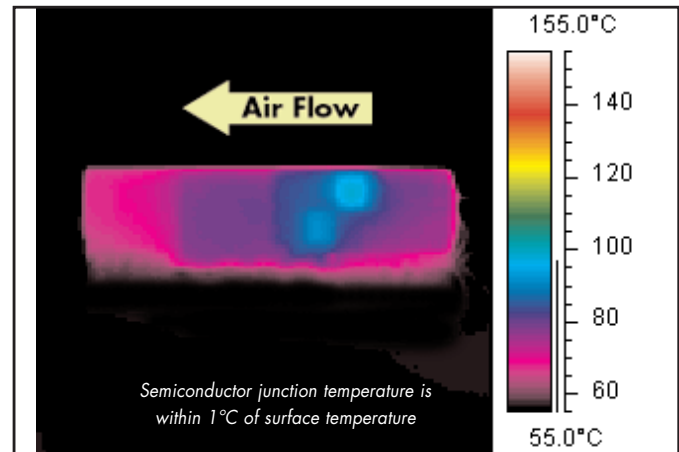

Figure 10: Thermal plot of 1.5V converter at 15 amp load current with 55°C air flowing at the rate of 200 LFM. Air is flowing across the converter sideways from pin 11 to pin 1 (V_{in} nom, vert mount).

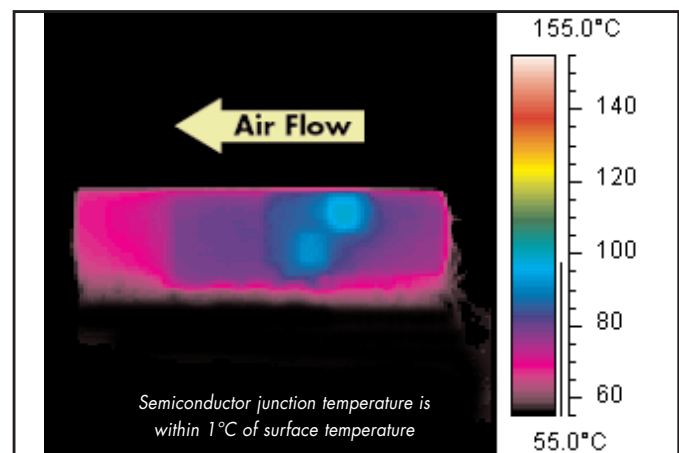

Figure 12: Thermal plot of 1.8V converter at 15 amp load current with 55°C air flowing at the rate of 200 LFM. Air is flowing across the converter sideways from pin 11 to pin 1 (V_{in} nom, vert mount).

Performance Curves

Non-Isolated
SIP Converter

3.0 - 3.6V_{in} 15A

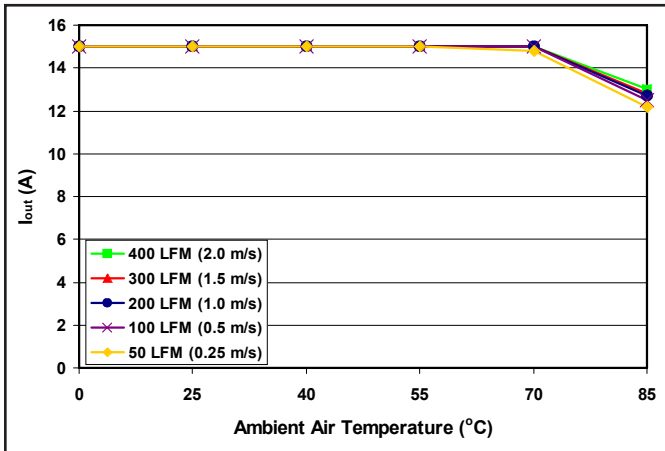

Figure 13: Maximum output power derating curves vs. ambient air temperature for 2.5V_{out} unit. Airflow rates of 50 LFM - 400 LFM with air flowing across the converter from pin 11 to pin 1 (V_{in} nom, vert mount).

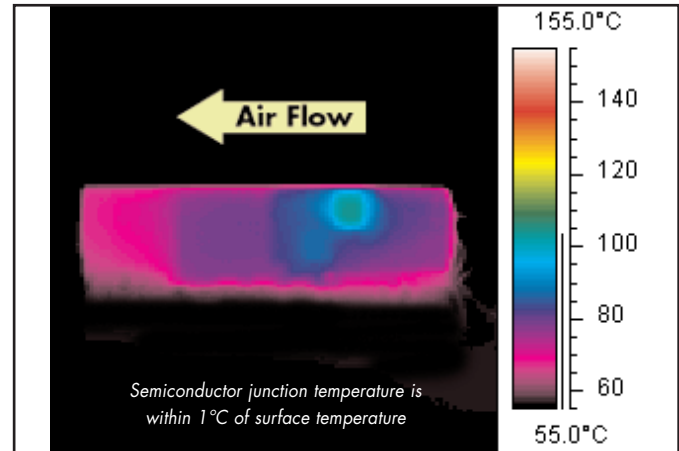

Figure 14: Thermal plot of 2.5V converter at 15 amp load current with 55°C air flowing at the rate of 200 LFM. Air is flowing across the converter sideways from pin 11 to pin 1 (V_{in} nom, vert mount).

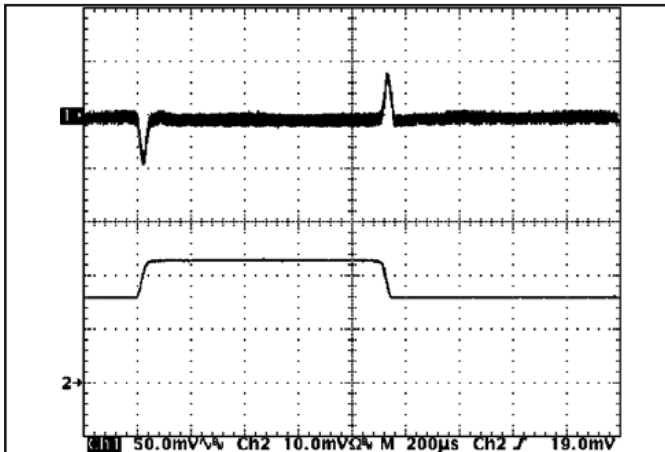

Figure 15: Output voltage response for 0.9V unit to step-change in load current (50-75-50% of I_{out} max; di/dt=0.1A/µs). Load cap: 10µF, 100mΩ ESR tantalum and 1µF ceramic. Ch 1: V_{out} (50mV/div), Ch 2: I_{out} (5A/div).

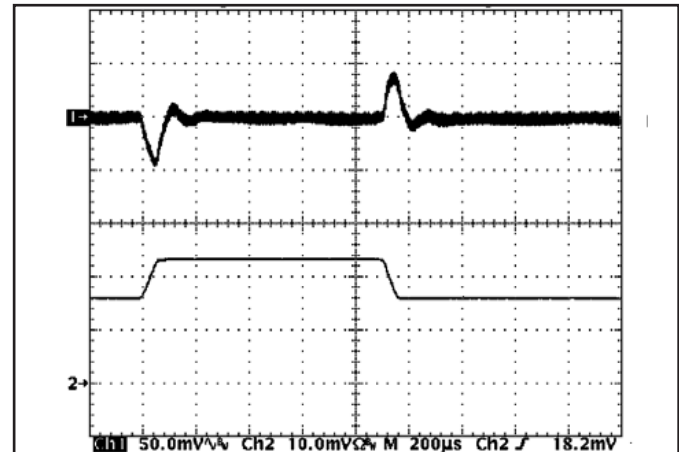

Figure 16: Output voltage response for 2.5V unit to step-change in load current (50-75-50% of I_{out} max; di/dt=0.1A/µs). Load cap: 10µF, 100mΩ ESR tantalum and 1µF ceramic. Ch 1: V_{out} (50mV/div), Ch 2: I_{out} (5A/div).

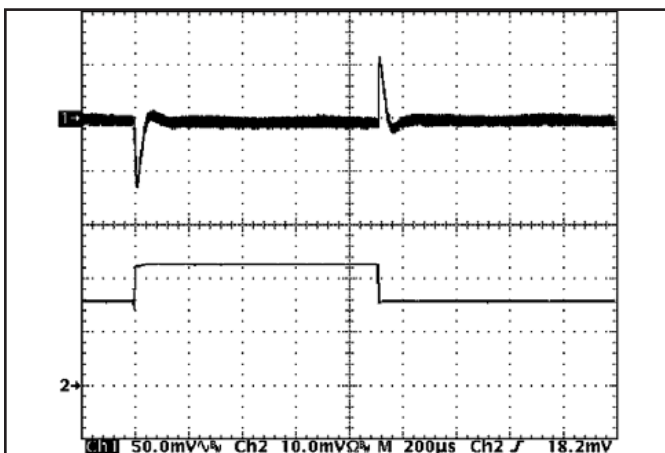

Figure 17: Output voltage response for 0.9V unit to step-change in load current (50-75-50% of I_{out} max; di/dt=5A/µs). Load cap: 470µF, 25mΩ ESR tantalum and 1µF ceramic. Ch 1: V_{out} (50mV/div), Ch 2: I_{out} (5A/div).

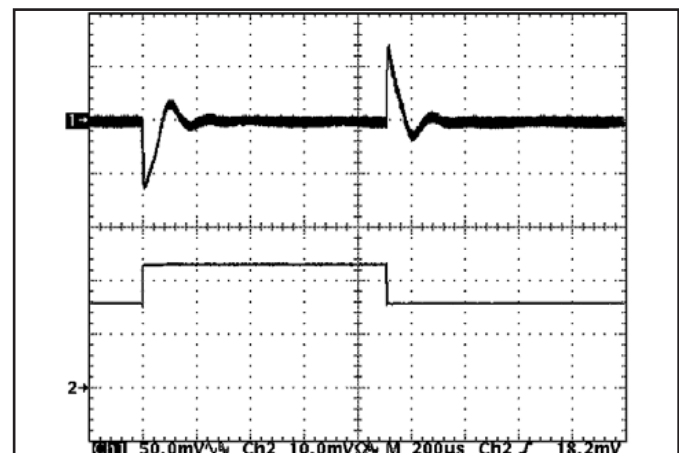

Figure 18: Output voltage response for 2.5V unit to step-change in load current (50-75-50% of I_{out} max; di/dt=5A/µs). Load cap: 470µF, 25mΩ ESR tantalum and 1µF ceramic. Ch 1: V_{out} (50mV/div), Ch 2: I_{out} (5A/div).

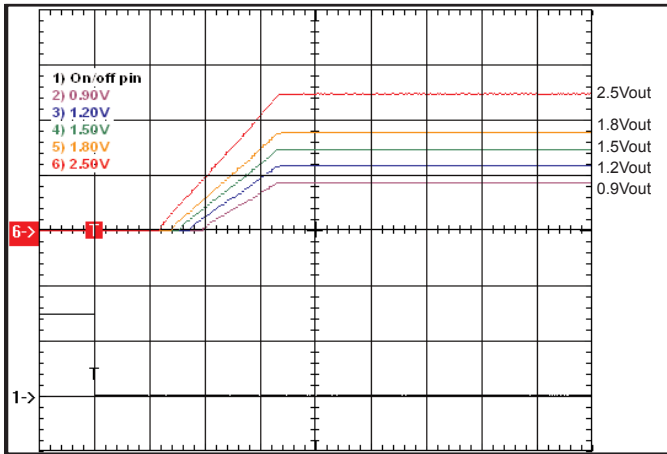

Figure 19: Turn-on transient at full load (resistive load) (2 ms/div).
Ch 1: ON/OFF input (2V/div)
Ch 2-6: V_{out} (1V/div)

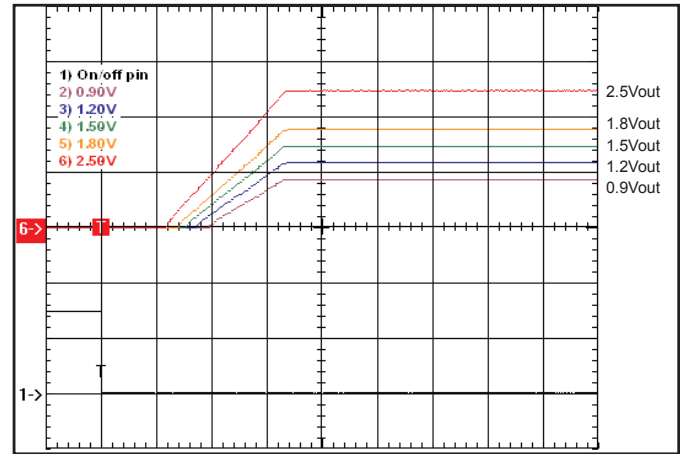

Figure 20: Turn-on transient at zero load (2 ms/div).
Ch 1: ON/OFF input (2V/div)
Ch 2-6: V_{out} (1V/div)

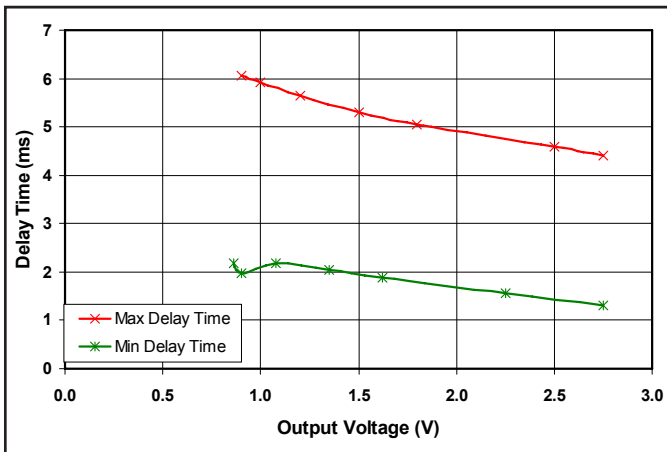

Figure 21: Minimum and Maximum Startup Delay Time (enable to 10%) over temperature versus output voltage (includes trimming).

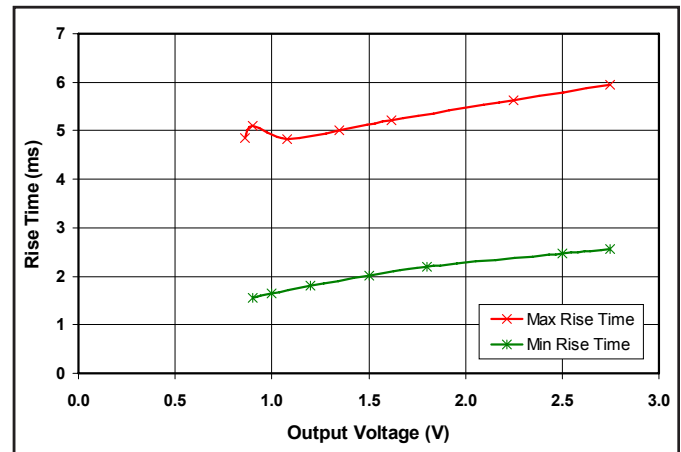

Figure 22: Minimum and Maximum Startup Rise Time (10% to 90%) over temperature versus output voltage (includes trimming).

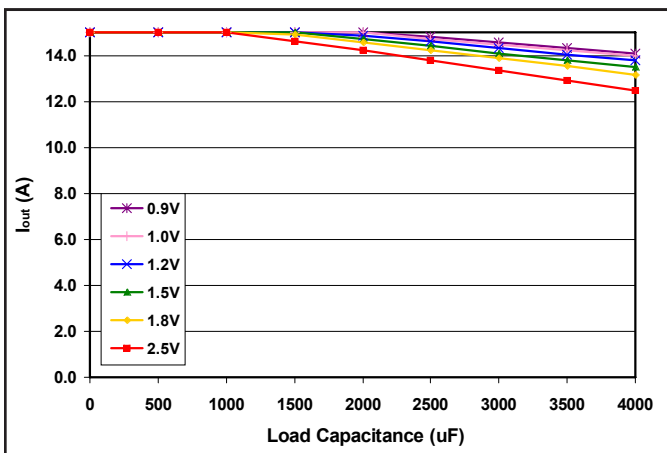

Figure 23: Maximum Startup Load Current versus Load Capacitance. Derate the load during startup according to this figure to avoid the possibility of over-current shutdown.

Performance Curves

Non-Isolated
SIP Converter

3.0 - 3.6V_{in} 15A

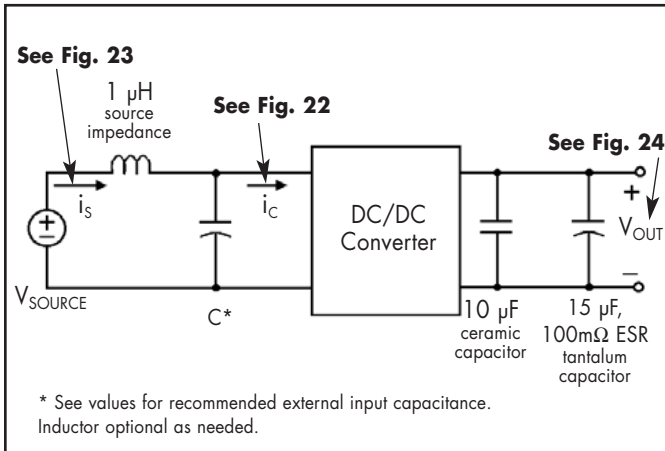

Figure 24: Test set-up diagram showing measurement points for Input Terminal Ripple Current (Figure 25), Input Reflected Ripple Current (Figure 26) and Output Voltage Ripple (Figure 27).

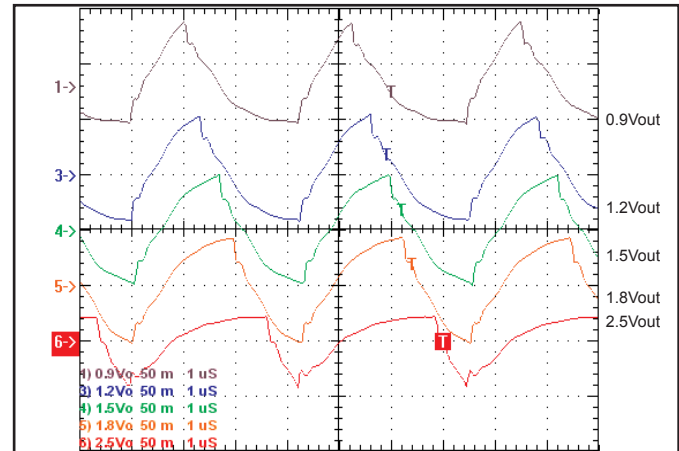

Figure 25: Input Terminal Ripple Current, i_c , at full rated output current and nominal input voltage with 1 μ H source impedance and 200 μ F tantalum capacitor (5A/div). See Figure 24.

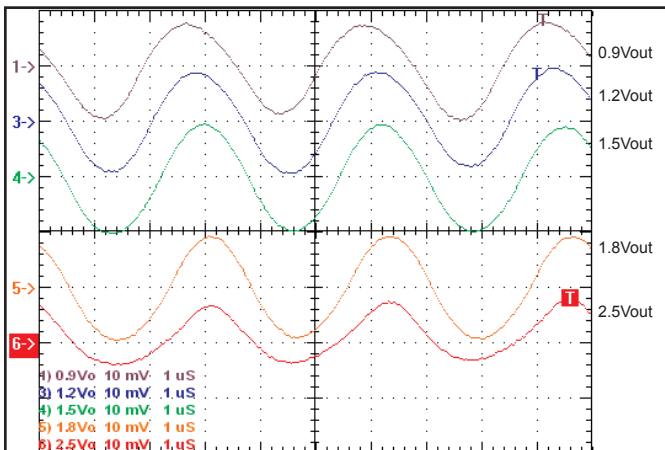

Figure 26: Input Reflected Ripple Current, i_s , through a 1 μ H source inductor at nominal input voltage and rated load current (100 mA/div). See Figure 24.

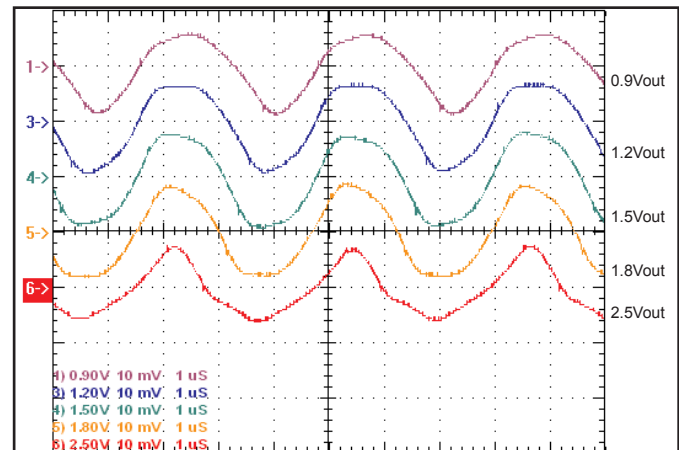

Figure 27: Output Voltage Ripple at nominal input voltage and rated load current (10 mV/div). Load capacitance: 10 μ F ceramic capacitor and 15 μ F tantalum capacitor. Bandwidth: 20 MHz. See Figure 24.

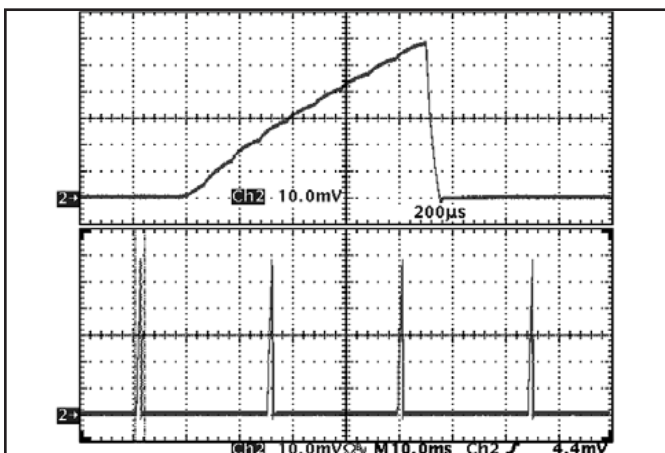

Figure 28: Load current (5A/div) as a function of time when 0.9V converter attempts to turn on into a 10 m Ω short circuit. Top trace (10ms/div) is an expansion of the on-time portion of the bottom trace.

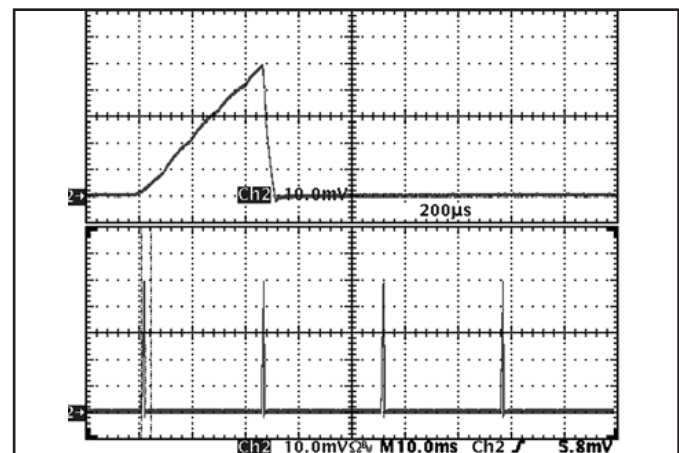

Figure 29: Load current (5A/div) as a function of time when 2.5V converter attempts to turn on into a 10 m Ω short circuit. Top trace (10ms/div) is an expansion of the on-time portion of the bottom trace.

Performance Curves

Non-Isolated
SIP Converter

3.0 - 3.6V_{in} 15A

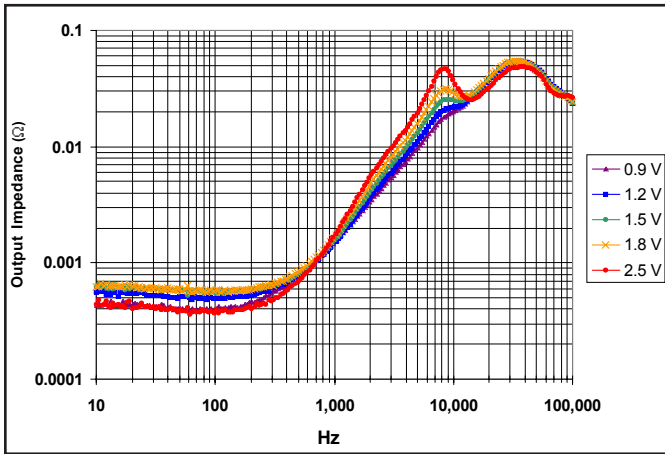

Figure 30: Magnitude of incremental output impedance ($Z_{out} = v_{out}/i_{out}$) for nominal input voltage at full rated power.

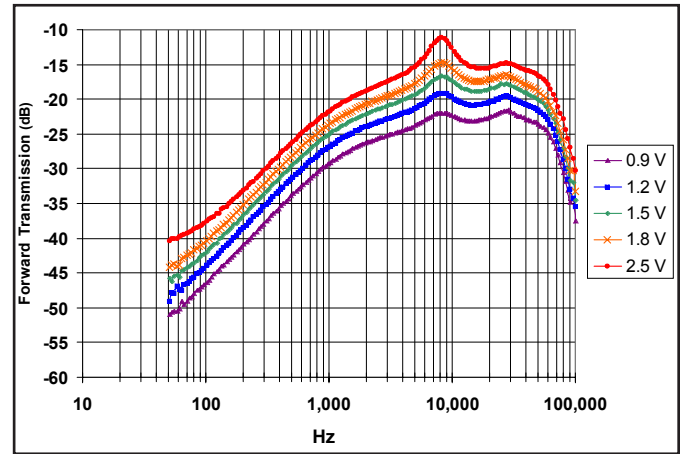

Figure 31: Magnitude of incremental forward transmission ($FT = v_{out}/v_{in}$) for nominal input voltage at full rated power.

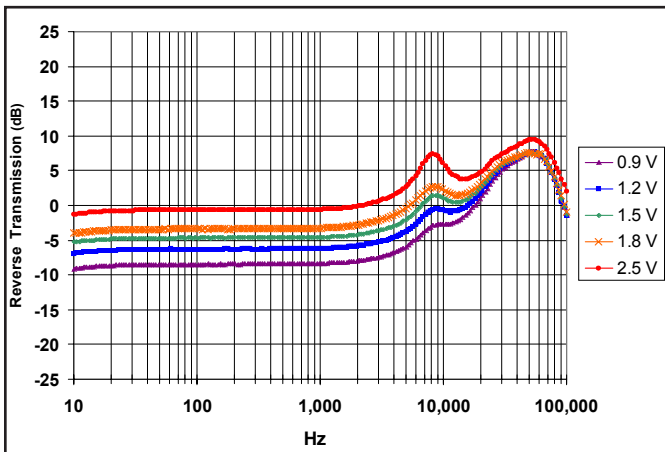

Figure 32: Magnitude of incremental reverse transmission ($RT = i_{in}/i_{out}$) for nominal input voltage at full rated power.

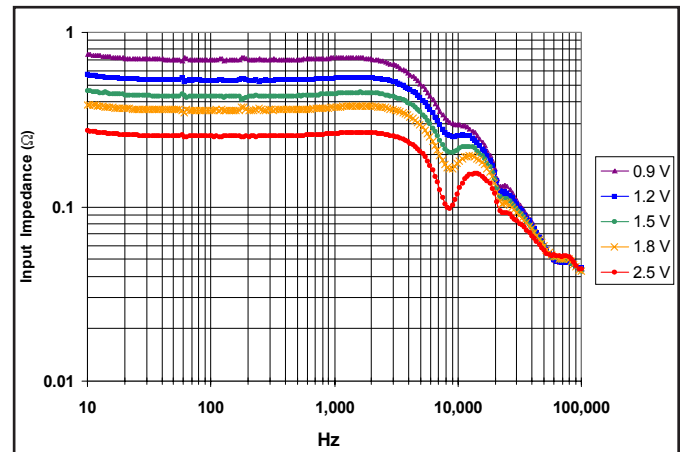

Figure 33: Magnitude of incremental input impedance ($Z_{in} = v_{in}/i_{in}$) for nominal input voltage at full rated power.

Technical Specification

**Non-Isolated
SIP Converter**

3.0 - 3.6V_{in} 15A

BASIC OPERATION AND FEATURES

The NiQor series non-isolated converter uses a buck-converter that keeps the output voltage constant over variations in line, load, and temperature. The NiQor modules employ synchronous rectification for very high efficiency.

Dissipation throughout the converter is so low that it does not require a heatsink or metal baseplate for operation. The NiQor converter can thus be built more simply and reliably using high yield surface mount techniques on a single PCB substrate.

The NiQor series of SIPs and SMT converters uses the established industry standard footprint and pin-out configurations.

CONTROL FEATURES

REMOTE ON/OFF (Pin 11): The ON/OFF input, Pin 11, permits the user to control when the converter is on or off. There are currently two options available for the ON/OFF input as described in the table below. Other options may be added based on user demand.

| Option | Description | Pin-Open Converter state | Pin Action |
|---------|---------------|--------------------------|-----------------|
| N Logic | Negative | Off | Pull Low = On |
| O Logic | Negative/Open | On | Pull High = Off |

Figure A is a schematic view of the internal ON/OFF circuitry.

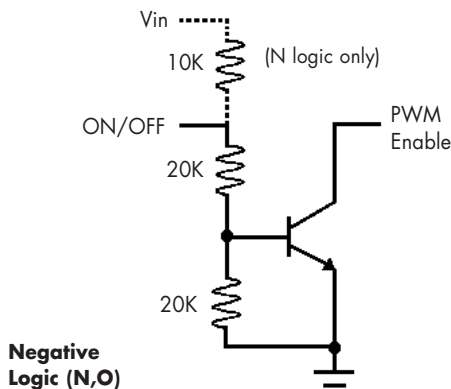

Figure A: Schematic view of the internal ON/OFF circuitry

OUTPUT VOLTAGE TRIM (Pin 10): The TRIM input permits the user to adjust the output voltage up or down according to the trim range specifications by using an external resistor or a voltage source. If the TRIM feature is not being used, leave the TRIM pin disconnected.

TRIM-DOWN: To decrease the output voltage using an external

resistor, connect the resistor $R_{trim-down}$ between Pin 10 (TRIM) and the V_{out} pins or the SENSE pin. For a desired decrease of the nominal output voltage, the value of the resistor should be:

$$R_{trim-down} = \left[\left(\frac{V_{OUT} - 0.80}{|\Delta V_{OUT}|} - 1 \right) \times 30100 \right] - R_{buffer} \quad (\Omega)$$

where V_{OUT} = Nominal Output Voltage

ΔV_{OUT} = Nominal V_{OUT} - Desired V_{OUT}

R_{buffer} = defined in Table 1 below
(value internal to the module)

| V_{out} set | R_{buffer} |
|---------------|-----------------|
| 3.3 V | 59 k Ω |
| 2.5 V | 78.7 k Ω |
| 1.8 V | 100 k Ω |
| 1.5 V | 100 k Ω |
| 1.2 V | 59 k Ω |
| 0.9 V | 5.11 k Ω |

Note: wide trim unit has trim range from 0.85-2.75V. Nominal voltage is 0.9V. Use R_{buffer} value of 5.11k Ω . when trimming.

Table 1: R_{buffer} values for NiQor trim equation

For example, to trim-down the output voltage of a 1.8V module by 5% to 1.71V, the $R_{trim-down}$ resistor value is calculated as follows:

$$V_{OUT} = 1.8V$$

$$\Delta V_{OUT} = 1.8V - 1.71V = 0.09V$$

$$R_{buffer} = 100k\Omega$$

$$R_{trim-down} = \left[\left(\frac{1.8 - 0.8}{0.09 - 1} \right) \times 30100 \right] - 100000 = 204.34k\Omega$$

TRIM-UP: To increase the output voltage using an external resistor, connect the resistor $R_{trim-up}$ between Pin 10 (TRIM) and the Common Ground Pins. For a desired increase of the nominal output voltage, the value of the resistor should be:

$$R_{trim-up} = \frac{24080}{|\Delta V_{OUT}|} - R_{buffer} \quad (\Omega)$$

where ΔV_{OUT} = Nominal V_{OUT} - Desired V_{OUT}

R_{buffer} = defined in Table 1

For example, to trim-up the output voltage of a 2.5V module by 10% to 2.75V, the $R_{trim-up}$ resistor value is calculated as follows:

$$\Delta V_{OUT} = 2.5V - 2.75V = 0.25V$$

$$R_{buffer} = 78.7k\Omega$$

$$R_{trim-up} = (24080/0.25) - 78700 = 17.62k\Omega$$

Note: the TRIM feature does not affect the voltage at which the output over-voltage protection circuit is triggered. Trimming the

Technical Specification

Non-Isolated
SIP Converter

3.0 - 3.6V_{in} 15A

output voltage too high may cause the over-voltage protection circuit to engage, particularly during transients.

Total DC Variation of Vout: For the converter to meet its specifications, the maximum variation of the DC value of Vout, due to both trimming and remote load voltage drops, should not be greater than that specified for the output voltage trim range.

PROTECTION FEATURES

Input Under-Voltage Lockout: The converter is designed to turn off when the input voltage is too low, helping avoid an input system instability problem, described in more detail in the application note titled "Input System Instability". The lockout circuitry is a comparator with DC hysteresis. When the input voltage is rising, it must exceed the typical Turn-On Voltage Threshold value (listed on the specification page) before the converter will turn on. Once the converter is on, the input voltage must fall below the typical Turn-Off Voltage Threshold value before the converter will turn off.

Over Current Shutdown: The converter uses the control (high-side) MOSFET on-resistance to detect short circuit or excessive over-current conditions. The converter compensates for the temperature variation of the MOSFET on-resistance, keeping the overcurrent threshold roughly constant over temperature. Very short (<1mS) over-current pulses will see a slightly higher apparent threshold than longer duration over-current events. This makes the converter less susceptible to shutdown from transient load conditions. However, once the over-current threshold is reached the converter ceases PWM operation within microseconds. After an over-current shutdown, the converter will remain off for an inhibit period of 18 to 32 milliseconds, and then attempt a soft-start. Depending on the impedance or current level of the overload condition, the converter will enter a "hiccup mode" where it repeatedly turns on and off at a frequency of 25 to 50 Hz, until the overload or short circuit condition is removed.

Output Over-Voltage Limit: If the voltage across the output pins exceeds the Output Over-Voltage Protection threshold, the converter will immediately stop switching. This prevents damage to the load circuit due to 1) excessive series resistance in output current path from converter output pins to sense point, 2) a release of a short-circuit condition, or 3) a release of a current limit condition. Load capacitance determines exactly how high the output voltage will rise in response to these conditions. After 2-4 ms, the converter will automatically restart. Note the wide trim model uses the OVP threshold of the 2.5V unit.

Over-Temperature Shutdown: A temperature sensor on the converter senses the average temperature of the module. The thermal shutdown circuit is designed to turn the converter off when the temperature at the sensed location reaches the Over-Temperature Shutdown value. It will allow the converter to turn on again when the temperature of the sensed location falls by the amount of the Over-Temperature Shutdown Restart Hysteresis value.

APPLICATION CONSIDERATIONS

Input and Output Filtering: SynQor recommends an external input capacitor of either a tantalum, polymer or aluminum electrolytic type on the input of the NQ03/NQ04 series non-isolated converters. This capacitance and resistance primarily provides damping of the input filter, reduces the source impedance and guarantees input stability (see SynQor application note "Input System Instability"). The input filter is formed by any source or wiring inductance and the converter's input capacitance. The external capacitance also provides an additional benefit of ripple voltage reduction.

A modest sized capacitor would suffice in most conditions, such as a 330µF, 16V tantalum, with an ESR of approximately 50 mΩ. The NiQor family converters have an internal ceramic input capacitor to reduce ripple current stress on the external capacitors. An external ceramic capacitor of similar size (330µF) with a series resistor of approximately 50 mΩ would also suffice and would provide the filter damping.

Additional ceramic capacitance may be needed on the input, in parallel with the tantalum capacitor, to relieve ripple current stress on the tantalum capacitors. The external capacitance forms a current divider with the 40µF internal ceramic capacitance. At 300 kHz., the impedance of the internal capacitance is about 15mΩ capacitive. At that frequency, an SMT 330µF tantalum capacitor would have an impedance of about 50mΩ resistive, essentially just the ESR.

In this example, at full load, that would stress the tantalum input capacitor to about 3A rms ripple current, possibly beyond its rating. Placing an additional 40µF of ceramic in parallel with that capacitor would reduce the ripple current to about 1.5A, probably within its rating at 85°C. The input ripple current is proportional to load current, so this example should be scaled down according to the actual load current.

Additional input capacitance equal to half of the output capacitance is recommended when operating with more than 1000µF of output capacitance on a 1.5V or higher output voltage, or on lower voltage outputs when trimming down by more than

Technical Specification

**Non-Isolated
SIP Converter**

3.0 - 3.6V_{in} 15A

half of the trim-down allowance (e.g., further than -2.5% on a 0.9V, or -5% on a 1.2V).

If no inductor is used to isolate the input ripple of the *NiQor* converters from the source or from inputs of other *NiQor* converters, then this external capacitance might be provided by the DC/DC converter used as the power source. SynQor's *PowerQor* series converters typically have tantalum and ceramic output capacitors that would provide the damping.

An input inductor would help isolate the ripple currents and voltages from the source or other *NiQor* style converters on the voltage supply rail. If an input inductor is used, the recommended capacitance should guarantee stability and control the ripple current for up to 1.0 μ H of input inductance.

The input inductor need not have very high inductance. A value of 500 nanohenries would equate to almost one ohm of series impedance at the switching frequency of 300 kHz. This would be working against an assumed capacitive ESR of 30m Ω on the supply side of the inductor, providing significant isolation and ripple reduction.

No external capacitance is required at the output, however, the ripple voltage can be further reduced if ceramic and tantalum capacitors are added at the output. Since the internal output capacitance is about 50 μ F, approximately that amount of capacitance would be needed to produce a noticeable reduction in output ripple. The value of the tantalum capacitors is both to provide a high capacitance for pulsed loads and to provide damping of the distribution network with their inherent ESR, which is low, but higher than ceramics. Additional output capacitance in the range of 300-500 μ F is beneficial for reducing the deviation in response to a fast load transient.

Input Over-Voltage Prevention: The power system designer must take precautions to prevent damaging the *NiQor* converters by input overvoltage. This is another reason to be careful about damping the input filter so that no ringing occurs from an underdamped filter. The voltage must be prevented from exceeding the absolute maximum voltage indicated in the Electrical Specifications section of the data sheet under all conditions of turn-on, turn-off and load transients and fault conditions. The power source should have an over voltage shutdown threshold as close as reasonably possible to the operating point.

Additional protection can come from additional input capacitance, perhaps on the order of 1,000 μ F, but contingent on the source inductance value. A large source inductance would require more capacitance to keep the input voltage below the absolute maximum, if the load current were interrupted sud-

denly. This can be caused by either a shutdown of the *NiQor* from a fault or from the load itself, for example when a card is hot-swapped out, suddenly dropping the load to zero. This is further justification for keeping the source inductance low, as mentioned above. When the power source is configured with remote sensing, the series resistance of the filter inductor and any other conductors or devices between the source and the sense point will result in a voltage drop which, in the event of a load current interruption, would add to the *NiQor* input voltage.

A TVS device could also be used to clamp the voltage level during these conditions, but the relatively narrow range between operating voltage and the absolute maximum voltage restrict the use of these devices to lower source current levels that will not drive the transient voltage suppressor above the voltage limit when all the source current is flowing into the clamp. A TVS would be a good supplemental control, in addition to careful selection of inductance and capacitance values.

Equivalent Model for Input Ripple: A simple but reasonably accurate model of input ripple is to treat the *NiQor* input as a pulsed AC current source at 300 kHz, in parallel with a very low ESR capacitor, see Figure B. The peak-to-peak current of the source model is equal to the *NiQor* load current, representing the peak current in the *NiQor*'s smoothing choke. The capacitor represents the 40 μ F input ceramic capacitance of the *NiQor* converter, with a nearly negligible ESR of less than 1 m Ω . A further refinement can be made by setting the duty cycle of the pulsed source to the output voltage divided by the input voltage.

The only error in this simplified model is that it ignores the inductive current in the choke, usually less than 20% of the load current, and it ignores the resistive losses inside the *NiQor* converter, which would alter the duty cycle very slightly.

The model is a good guide for calculating the effects of external input capacitors and other filter elements on ripple voltage and ripple current stress on capacitors.

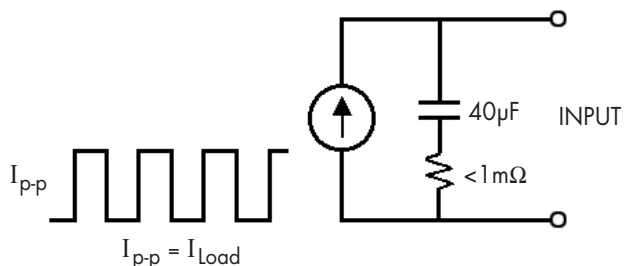

Figure B: Equivalent model for input ripple

Technical Specification

Non-Isolated
SIP Converter

3.0 - 3.6V_{in} 15A

High Capacitance Loads with Backdrive: When using two or more NiQor converters with high capacitance loads (greater than 1,000µF), special consideration must be given to the following condition. If a back-drive source is feeding voltage back to a NiQor output, perhaps through some ASIC or other load device, and the back-driving source is greater than 60% of the *input voltage* to the NiQor that has not been enabled yet, an overcurrent condition may exist on startup. This condition could prevent a proper startup when the second NiQor is enabled. The condition is caused by the second NiQor having to ramp the voltage to a high duty cycle with a high capacitance load, which can trip the overcurrent shut-down, preventing a startup. The following remedies for this situation can be applied:

- 1) Limit output capacitance on higher voltage outputs to 1,000µF. OR,
- 2) Prevent back-drive conditions that raise the off-state output voltage to more than 60% of the input voltage.

Thermal Considerations: For vertical mount applications at elevated temperatures that call for forced air cooling (see thermal derating curves), the preferred airflow direction is from pin 11 to pin 1, as indicated in the thermal images provided. If airflow is in the opposite direction (pin 1 to pin 11) the power devices will run hotter by about 5 °C (corresponding to an additional 1 ampere of load derating at conditions where derating occurs).

For horizontal mount applications (NQ0xxxHMA parts), where the inductor and power devices are facing down, the preferred airflow direction is into the leading edge opposite the pin header edge, such that air flowing under the NiQor PCB flows out between the pins and the inductor. With this airflow direction, and with the inductor firmly contacting the application board, the user can apply the thermal derating curves provided herein for vertical mount with airflow from pin 11 to pin 1. Airflows in other directions across the horizontally mounted NiQor will result in temperatures that are higher by about 5 °C with pin 11 to pin 1 airflow and about 10 °C with pin 1 to pin 11 airflow. Also, temperature increases of up to 10 °C (2 Amp lower derating) can be expected if the inductor thermal interface does not make good contact to the customer's circuit board.

Layout Suggestion: When using a fixed output NiQor converter, the designer may chose to use the trim function and would thus be required to reserve board space for a trim resistor. It is suggested that even if the designer does not plan to use the trim function, additional space should be reserved on the board for a trim resistor. This will allow the flexibility to use the

wide output voltage trim range NiQor module at a later date. Any trim resistor should connect to the ground or output node at one of the respective pins of the NiQor, so as to prevent the trim level from being affected by load drops through the ground or power planes.

OPTIONAL FEATURES

REMOTE SENSE(+) (Pin 3 - **Optional**): The optional SENSE(+) input corrects for voltage drops along the conductors that connect the converter's output pins to the load.

Pin 3 should be connected to Vout(+) at the point on the board where regulation is desired. A remote connection at the load can adjust for a voltage drop only as large as that specified in this datasheet, that is

$$V_{out(+)} - SENSE(+) \leq \text{Sense Range \%} \times V_{out}$$

Pin 3 must be connected for proper regulation of the output voltage. If these connections are not made, the converter will deliver an output voltage that is slightly higher than its specified value.

Note: the output over-voltage protection circuit senses the voltage across the output (pins 1, 2 and 4) to determine when it should trigger, not the voltage across the converter's sense lead (pin 3).

CURRENT SHARE (Pin A - **Optional**): Additional information on the current share feature will be provided in a future revision of this technical specification. Please contact SynQor engineering support for further details.



Technical Specification

**Non-Isolated
SIP Converter** **3.0 - 3.6V_{in}** **15A**

PART NUMBERING SYSTEM

The part numbering system for SynQor's NiQor DC/DC converters follows the format shown in the example below.

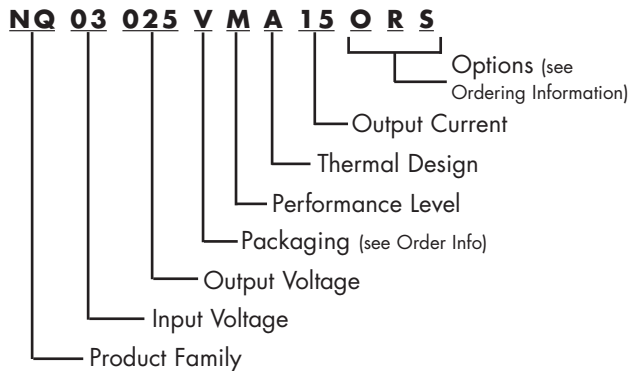

The first 12 characters comprise the base part number and the last 3 characters indicate available options. Although there are no default values for packaging, enable logic, pin length and feature set, the most common options are vertical mount SIP (V), Negative/Open logic (O), 0.160" pins (R) and Sense feature set (S). These part numbers are more likely to be readily available in stock for evaluation and prototype quantities.

Application Notes

A variety of application notes and technical white papers can be downloaded in pdf format at www.synqor.com.

Contact SynQor for further information:

Phone: 978-849-0600
Toll Free: 888-567-9596
Fax: 978-849-0602
E-mail: sales@synqor.com
Web: www.synqor.com
Address: 155 Swanson Road
 Boxborough, MA 01719

ORDERING INFORMATION

The tables below show the valid model numbers and ordering options for converters in this product family. When ordering SynQor converters, please ensure that you use the complete 15 character part number consisting of the 12 character base part number and the additional 3 characters for options.

| Model Number | Input Voltage | Output Voltage | Max Output Current |
|--------------------------|---------------|----------------|--------------------|
| NQ03009p MA15xyz | 3.0 - 3.6 V | 0.9 V | 15 A |
| NQ03012p MA15xyz | 3.0 - 3.6 V | 1.2 V | 15 A |
| NQ03015p MA15xyz | 3.0 - 3.6 V | 1.5 V | 15 A |
| NQ03018p MA15xyz | 3.0 - 3.6 V | 1.8 V | 15 A |
| NQ03025p MA15xyz | 3.0 - 3.6 V | 2.5 V | 15 A |
| NQ03T25p MA15xyz* | 3.0 - 3.6 V | 0.85-2.75V | 15 A |

* Nominal output voltage for this unit is 0.9V and it must be trimmed up or down for any other desired voltage.

The following option choices must be included in place of the *p x y z* spaces in the model numbers listed above.

| Packaging: <i>p</i> | Options Description: <i>xyz</i> | | |
|--|---------------------------------|---|------------------------------|
| Packaging | Enable Logic | Pin Style | Feature Set |
| V - Vert. Mount SIP H - Horz. Mount SIP | N - Negative O - Neg/Open | R - 0.160" (Standard) V - 0.160" (Vert Reversed) | S - Sense (Std.) N - None |

Warranty

SynQor offers a three (3) year limited warranty. Complete warranty information is listed on our web site or is available upon request from SynQor.

Information furnished by SynQor is believed to be accurate and reliable. However, no responsibility is assumed by SynQor for its use, nor for any infringements of patents or other rights of third parties which may result from its use. No license is granted by implication or otherwise under any patent or patent rights of SynQor.