



# MICROCHIP MCP14E3/MCP14E4/MCP14E5

## 4.0A Dual High-Speed Power MOSFET Drivers With Enable

### Features

- High Peak Output Current: 4.0A (typical)
- Independent Enable Function for Each Driver Output
- Low Shoot-Through/Cross-Conduction Current in Output Stage
- Wide Input Supply Voltage Operating Range:
  - 4.5V to 18V
- High Capacitive Load Drive Capability:
  - 2200 pF in 15 ns (typical)
  - 5600 pF in 26 ns (typical)
- Short Delay Times: 50 ns (typical)
- Latch-Up Protected: Will Withstand 1.5A Reverse Current
- Logic Input Will Withstand Negative Swing Up To 5V
- Space-Saving Packages:
  - 8-Lead 6x5 DFN, PDIP, SOIC

### Applications

- Switch Mode Power Supplies
- Pulse Transformer Drive
- Line Drivers
- Motor and Solenoid Drive

### General Description

The MCP14E3/MCP14E4/MCP14E5 devices are a family of 4.0A buffers/MOSFET drivers. Dual-inverting, dual-noninverting, and complementary outputs are standard logic options offered.

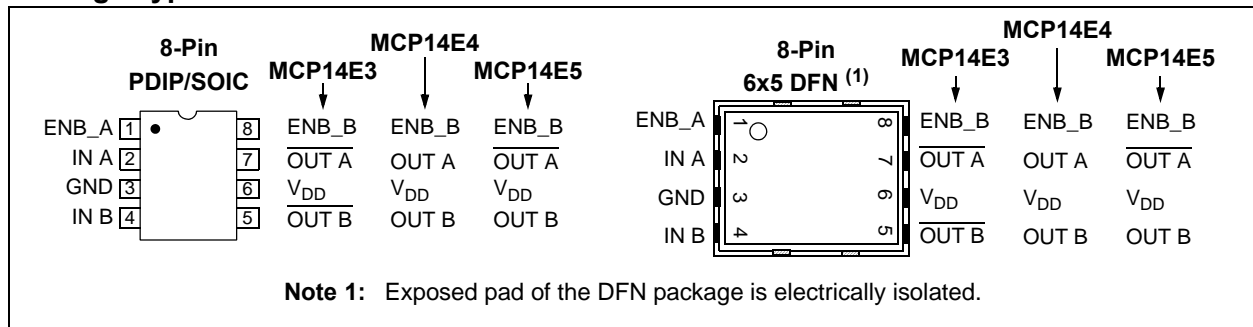
The MCP14E3/MCP14E4/MCP14E5 drivers are capable of operating from a 4.5V to 18V single power supply and can easily charge and discharge 2200 pF gate capacitance in under 15 ns (typical). They provide low impedance in both the ON and OFF states to ensure the MOSFET's intended state will not be affected, even by large transients. The MCP14E3/MCP14E4/MCP14E5 inputs may be driven directly from either TTL or CMOS (2.4V to 18V).

Additional control of the MCP14E3/MCP14E4/MCP14E5 outputs is allowed by the use of separate enable functions. The ENB\_A and ENB\_B pins are active high and are internally pulled up to V<sub>DD</sub>. The pins maybe left floating for standard operation.

The MCP14E3/MCP14E4/MCP14E5 dual-output 4.0A driver family is offered in both surface-mount and pin-through-hole packages with a -40°C to +125°C temperature rating. The low thermal resistance of the thermally enhanced DFN package allows for greater power dissipation capability for driving heavier capacitive or resistive loads.

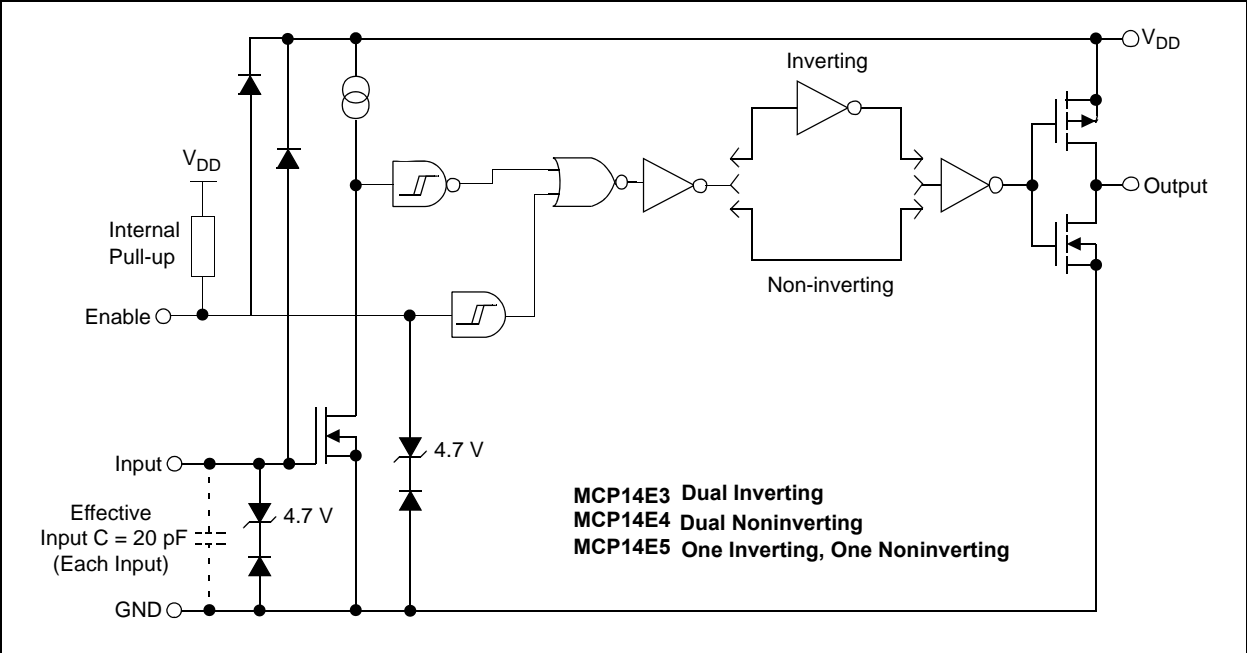
These devices are highly latch-up resistant under any conditions within their power and voltage ratings. They are not subject to damage when up to 5V of noise spiking (of either polarity) occurs on the ground pin. They can accept, without damage or logic upset, up to 1.5A of reverse current being forced back into their outputs. All terminals are fully protect against Electrostatic Discharge (ESD) up to 4 kV.

### Package Types



# MCP14E3/MCP14E4/MCP14E5

## Functional Block Diagram



# MCP14E3/MCP14E4/MCP14E5

## 1.0 ELECTRICAL CHARACTERISTICS

### Absolute Maximum Ratings †

|  |  |
|--|--|
| Supply Voltage .....                                   | +20V                                   |
| Input Voltage .....                                    | (V <sub>DD</sub> + 0.3V) to (GND - 5V) |
| Enable Voltage .....                                   | (V <sub>DD</sub> + 0.3V) to (GND - 5V) |
| Input Current (V <sub>IN</sub> >V <sub>DD</sub> )..... | 50 mA                                  |
| Package Power Dissipation (T <sub>A</sub> = 50°C)      |  |
| 8L-DFN .....   | <b>Note 3</b>                          |
| 8L-PDIP .....  | 1.10W                                  |
| 8L-SOIC .....  | 665 mW                                 |

† **Notice:** Stresses above those listed under "Maximum Ratings" may cause permanent damage to the device. This is a stress rating only and functional operation of the device at those or any other conditions above those indicated in the operational sections of this specification is not intended. Exposure to maximum rating conditions for extended periods may affect device reliability.

### DC CHARACTERISTICS (NOTE 2)

| Electrical Specifications: Unless otherwise indicated, T <sub>A</sub> = +25°C, with 4.5V ≤ V <sub>DD</sub> ≤ 18V. |                   |                         |      |                      |       |  |
|---|-------------------|-------------------------|------|----------------------|-------|--|
| Parameters  | Sym               | Min                     | Typ  | Max                  | Units | Conditions   |
| <b>Input</b>  |                   |                         |      |                      |       |  |
| Logic '1', High Input Voltage   | V <sub>IH</sub>   | 2.4                     | 1.5  | —                    | V     |  |
| Logic '0', Low Input Voltage  | V <sub>IL</sub>   | —                       | 1.3  | 0.8                  | V     |  |
| Input Current   | I <sub>IN</sub>   | -1                      | —    | 1                    | μA    | 0V ≤ V <sub>IN</sub> ≤ V <sub>DD</sub>             |
| Input Voltage   | V <sub>IN</sub>   | -5                      | —    | V <sub>DD</sub> +0.3 | V     |  |
| <b>Output</b>   |                   |                         |      |                      |       |  |
| High Output Voltage   | V <sub>OH</sub>   | V <sub>DD</sub> - 0.025 | —    | —                    | V     | DC Test  |
| Low Output Voltage  | V <sub>OL</sub>   | —                       | —    | 0.025                | V     | DC Test  |
| Output Resistance, High   | R <sub>OH</sub>   | —                       | 2.5  | 3.5                  | Ω     | I <sub>OUT</sub> = 10 mA, V <sub>DD</sub> = 18V    |
| Output Resistance, Low  | R <sub>OL</sub>   | —                       | 2.5  | 3.0                  | Ω     | I <sub>OUT</sub> = 10 mA, V <sub>DD</sub> = 18V    |
| Peak Output Current   | I <sub>PK</sub>   | —                       | 4.0  | —                    | A     | V <sub>DD</sub> = 18V ( <b>Note 2</b> )            |
| Latch-Up Protection Withstand Reverse Current   | I <sub>REV</sub>  | —                       | >1.5 | —                    | A     | Duty cycle ≤ 2%, t ≤ 300 μs                        |
| <b>Switching Time (Note 1)</b>  |                   |                         |      |                      |       |  |
| Rise Time   | t <sub>R</sub>    | —                       | 15   | 30                   | ns    | Figure 4-1, Figure 4-2<br>C <sub>L</sub> = 2200 pF |
| Fall Time   | t <sub>F</sub>    | —                       | 18   | 30                   | ns    | Figure 4-1, Figure 4-2<br>C <sub>L</sub> = 2200 pF |
| Propagation Delay Time  | t <sub>D1</sub>   | —                       | 46   | 55                   | ns    | Figure 4-1, Figure 4-2                             |
| Propagation Delay Time  | t <sub>D2</sub>   | —                       | 50   | 55                   | ns    | Figure 4-1, Figure 4-2                             |
| <b>Enable Function (ENB_A, ENB_B)</b>   |                   |                         |      |                      |       |  |
| High-Level Input Voltage  | V <sub>EN_H</sub> | 1.60                    | 1.90 | 2.90                 | V     | V <sub>DD</sub> = 12V, LO to HI Transition         |
| Low-Level Input Voltage   | V <sub>EN_L</sub> | 1.30                    | 2.20 | 2.40                 | V     | V <sub>DD</sub> = 12V, HI to LO Transition         |
| Hysteresis  | V <sub>HYST</sub> | 0.10                    | 0.30 | 0.60                 | V     |  |
| Enable Leakage Current  | I <sub>ENBL</sub> | 40                      | 85   | 115                  | μA    | V <sub>DD</sub> = 12V,<br>ENB_A = ENB_B = GND      |
| Propagation Delay Time  | t <sub>D3</sub>   | —                       | 60   | —                    | ns    | Figure 4-3 ( <b>Note 1</b> )                       |
| Propagation Delay Time  | t <sub>D4</sub>   | —                       | 50   | —                    | ns    | Figure 4-3 ( <b>Note 1</b> )                       |

**Note 1:** Switching times ensured by design.

**2:** Tested during characterization, not production tested.

**3:** Package power dissipation is dependent on the copper pad area on the PCB.

# MCP14E3/MCP14E4/MCP14E5

## DC CHARACTERISTICS (NOTE 2) (CONTINUED)

| Electrical Specifications: Unless otherwise indicated, $T_A = +25^\circ\text{C}$ , with $4.5\text{V} \leq V_{DD} \leq 18\text{V}$ . |          |     |      |      |       |  |
|---|----------|-----|------|------|-------|--|
| Parameters  | Sym      | Min | Typ  | Max  | Units | Conditions   |
| <b>Power Supply</b>   |          |     |      |      |       |  |
| Supply Voltage  | $V_{DD}$ | 4.5 | —    | 18.0 | V     |  |
| Supply Current  | $I_{DD}$ | —   | 1.60 | 2.00 | mA    | $V_{IN\_A} = 3\text{V}$ , $V_{IN\_B} = 3\text{V}$ ,<br>$ENB\_A = ENB\_B = \text{High}$ |
|   | $I_{DD}$ | —   | 0.60 | 0.90 | mA    | $V_{IN\_A} = 0\text{V}$ , $V_{IN\_B} = 0\text{V}$ ,<br>$ENB\_A = ENB\_B = \text{High}$ |
|   | $I_{DD}$ | —   | 1.20 | 1.40 | mA    | $V_{IN\_A} = 3\text{V}$ , $V_{IN\_B} = 0\text{V}$ ,<br>$ENB\_A = ENB\_B = \text{High}$ |
|   | $I_{DD}$ | —   | 1.20 | 1.40 | mA    | $V_{IN\_A} = 0\text{V}$ , $V_{IN\_B} = 3\text{V}$ ,<br>$ENB\_A = ENB\_B = \text{High}$ |
|   | $I_{DD}$ | —   | 1.40 | 1.80 | mA    | $V_{IN\_A} = 3\text{V}$ , $V_{IN\_B} = 3\text{V}$ ,<br>$ENB\_A = ENB\_B = \text{Low}$  |
|   | $I_{DD}$ | —   | 0.55 | 0.75 | mA    | $V_{IN\_A} = 0\text{V}$ , $V_{IN\_B} = 0\text{V}$ ,<br>$ENB\_A = ENB\_B = \text{Low}$  |
|   | $I_{DD}$ | —   | 1.00 | 1.20 | mA    | $V_{IN\_A} = 3\text{V}$ , $V_{IN\_B} = 0\text{V}$ ,<br>$ENB\_A = ENB\_B = \text{Low}$  |
|   | $I_{DD}$ | —   | 1.00 | 1.20 | mA    | $V_{IN\_A} = 0\text{V}$ , $V_{IN\_B} = 3\text{V}$ ,<br>$ENB\_A = ENB\_B = \text{Low}$  |

- Note 1:** Switching times ensured by design.  
**Note 2:** Tested during characterization, not production tested.  
**Note 3:** Package power dissipation is dependent on the copper pad area on the PCB.

# MCP14E3/MCP14E4/MCP14E5

## DC CHARACTERISTICS (OVER OPERATING TEMPERATURE RANGE)

| Electrical Specifications: Unless otherwise indicated, operating temperature range with $4.5V \leq V_{DD} \leq 18V$ . |             |                  |      |       |          |   |
|---|-------------|------------------|------|-------|----------|---|
| Parameters  | Sym         | Min              | Typ  | Max   | Units    | Conditions  |
| <b>Input</b>  |             |                  |      |       |          |   |
| Logic '1', High Input Voltage   | $V_{IH}$    | 2.4              | —    | —     | V        |   |
| Logic '0', Low Input Voltage  | $V_{IL}$    | —                | —    | 0.8   | V        |   |
| Input Current   | $I_{IN}$    | -10              | —    | +10   | $\mu A$  | $0V \leq V_{IN} \leq V_{DD}$                                  |
| <b>Output</b>   |             |                  |      |       |          |   |
| High Output Voltage   | $V_{OH}$    | $V_{DD} - 0.025$ | —    | —     | V        | DC TEST   |
| Low Output Voltage  | $V_{OL}$    | —                | —    | 0.025 | V        | DC TEST   |
| Output Resistance, High   | $R_{OH}$    | —                | 3.0  | 6.0   | $\Omega$ | $I_{OUT} = 10 \text{ mA}$ , $V_{DD} = 18V$                    |
| Output Resistance, Low  | $R_{OL}$    | —                | 3.0  | 5.0   | $\Omega$ | $I_{OUT} = 10 \text{ mA}$ , $V_{DD} = 18V$                    |
| <b>Switching Time (Note 1)</b>  |             |                  |      |       |          |   |
| Rise Time   | $t_R$       | —                | 25   | 40    | ns       | Figure 4-1, Figure 4-2<br>$C_L = 2200 \text{ pF}$             |
| Fall Time   | $t_F$       | —                | 28   | 40    | ns       | Figure 4-1, Figure 4-2<br>$C_L = 2200 \text{ pF}$             |
| Delay Time  | $t_{D1}$    | —                | 50   | 70    | ns       | Figure 4-1, Figure 4-2  |
| Delay Time  | $t_{D2}$    | —                | 50   | 70    | ns       | Figure 4-1, Figure 4-2  |
| <b>Enable Function (ENB_A, ENB_B)</b>   |             |                  |      |       |          |   |
| High-Level Input Voltage  | $V_{EN\_H}$ | 1.60             | 2.20 | 2.90  | V        | $V_{DD} = 12V$ , LO to HI Transition                          |
| Low-Level Input Voltage   | $V_{EN\_L}$ | 1.30             | 1.80 | 2.40  | V        | $V_{DD} = 12V$ , HI to LO Transition                          |
| Hysteresis  | $V_{HYST}$  | —                | 0.40 | —     | V        |   |
| Enable Leakage Current  | $I_{ENBL}$  | 40               | 87   | 115   | $\mu A$  | $V_{DD} = 12V$ , ENB_A = ENB_B = GND                          |
| Propagation Delay Time  | $t_{D3}$    | —                | 50   | —     | ns       | Figure 4-3  |
| Propagation Delay Time  | $t_{D4}$    | —                | 60   | —     | ns       | Figure 4-3  |
| <b>Power Supply</b>   |             |                  |      |       |          |   |
| Supply Voltage  | $V_{DD}$    | 4.5              | —    | 18.0  | V        |   |
| Supply Current  | $I_{DD}$    | —                | 2.0  | 3.0   | mA       | $V_{IN\_A} = 3V$ , $V_{IN\_B} = 3V$ ,<br>ENB_A = ENB_B = High |
|   | $I_{DD}$    | —                | 0.8  | 1.1   | mA       | $V_{IN\_A} = 0V$ , $V_{IN\_B} = 0V$ ,<br>ENB_A = ENB_B = High |
|   | $I_{DD}$    | —                | 1.5  | 2.0   | mA       | $V_{IN\_A} = 3V$ , $V_{IN\_B} = 0V$ ,<br>ENB_A = ENB_B = High |
|   | $I_{DD}$    | —                | 1.5  | 2.0   | mA       | $V_{IN\_A} = 0V$ , $V_{IN\_B} = 3V$ ,<br>ENB_A = ENB_B = High |
|   | $I_{DD}$    | —                | 1.8  | 2.8   | mA       | $V_{IN\_A} = 3V$ , $V_{IN\_B} = 3V$ ,<br>ENB_A = ENB_B = Low  |
|   | $I_{DD}$    | —                | 0.6  | 0.8   | mA       | $V_{IN\_A} = 0V$ , $V_{IN\_B} = 0V$ ,<br>ENB_A = ENB_B = Low  |
|   | $I_{DD}$    | —                | 1.1  | 1.8   | mA       | $V_{IN\_A} = 3V$ , $V_{IN\_B} = 0V$ ,<br>ENB_A = ENB_B = Low  |
|   | $I_{DD}$    | —                | 1.1  | 1.8   | mA       | $V_{IN\_A} = 0V$ , $V_{IN\_B} = 3V$ ,<br>ENB_A = ENB_B = Low  |

**Note 1:** Switching times ensured by design.

# MCP14E3/MCP14E4/MCP14E5

## TEMPERATURE CHARACTERISTICS

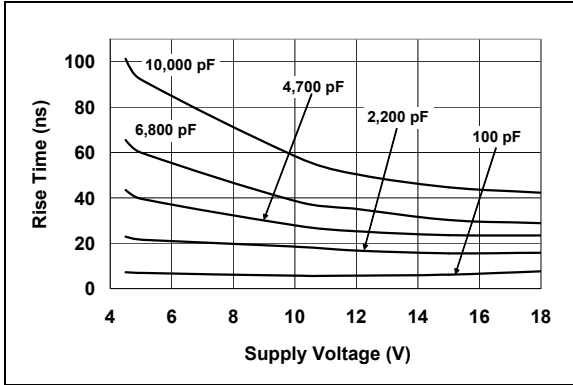
| <b>Electrical Specifications:</b> Unless otherwise noted, all parameters apply with $4.5V \leq V_{DD} \leq 18V$ . |               |     |       |      |       |  |
|---|---------------|-----|-------|------|-------|--|
| Parameters  | Sym           | Min | Typ   | Max  | Units | Conditions   |
| <b>Temperature Ranges</b>   |               |     |       |      |       |  |
| Specified Temperature Range   | $T_A$         | -40 | —     | +125 | °C    |  |
| Maximum Junction Temperature  | $T_J$         | —   | —     | +150 | °C    |  |
| Storage Temperature Range   | $T_A$         | -65 | —     | +150 | °C    |  |
| <b>Package Thermal Resistances</b>  |               |     |       |      |       |  |
| Thermal Resistance, 8L-6x5 DFN  | $\theta_{JA}$ | —   | 35.7  | —    | °C/W  | Typical four-layer board with vias to ground plane |
| Thermal Resistance, 8L-PDIP   | $\theta_{JA}$ | —   | 89.3  | —    | °C/W  |  |
| Thermal Resistance, 8L-SOIC   | $\theta_{JA}$ | —   | 149.5 | —    | °C/W  |  |

# MCP14E3/MCP14E4/MCP14E5

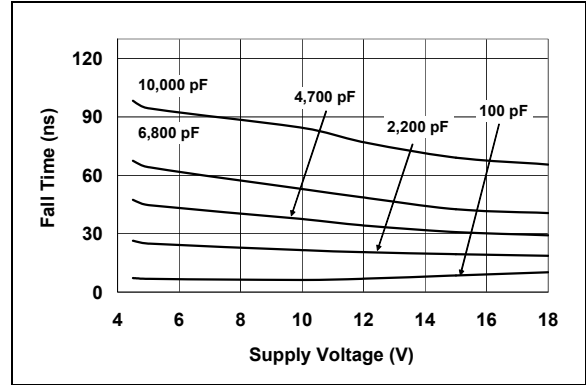
## 2.0 TYPICAL PERFORMANCE CURVES

**Note:** The graphs and tables provided following this note are a statistical summary based on a limited number of samples and are provided for informational purposes only. The performance characteristics listed herein are not tested or guaranteed. In some graphs or tables, the data presented may be outside the specified operating range (e.g., outside specified power supply range) and therefore outside the warranted range.

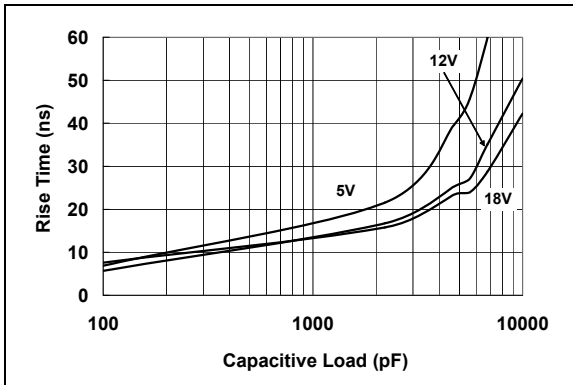
**Note:** Unless otherwise indicated,  $T_A = +25^\circ\text{C}$  with  $4.5\text{V} \leq V_{DD} \leq 18\text{V}$ .



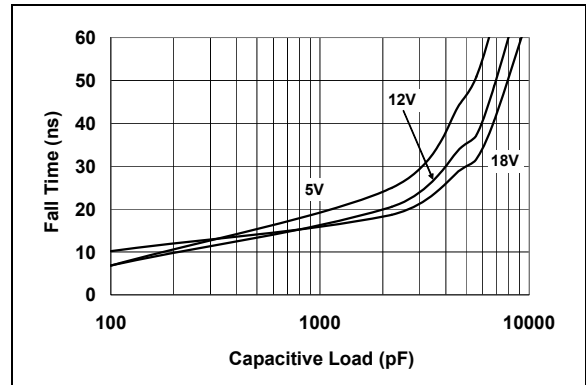
**FIGURE 2-1:** Rise Time vs. Supply Voltage.



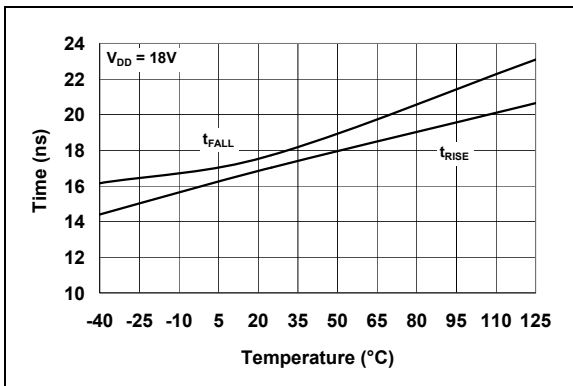
**FIGURE 2-4:** Fall Time vs. Supply Voltage.



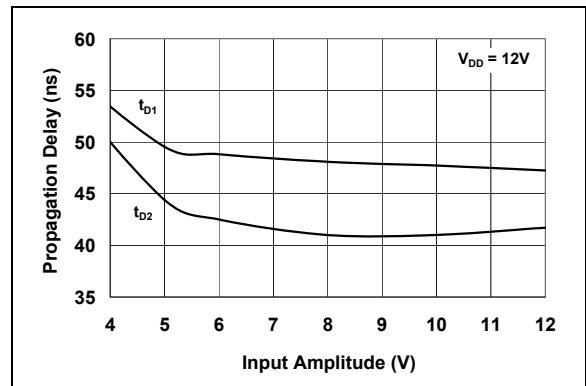
**FIGURE 2-2:** Rise Time vs. Capacitive Load.



**FIGURE 2-5:** Fall Time vs. Capacitive Load.



**FIGURE 2-3:** Rise and Fall Times vs. Temperature.

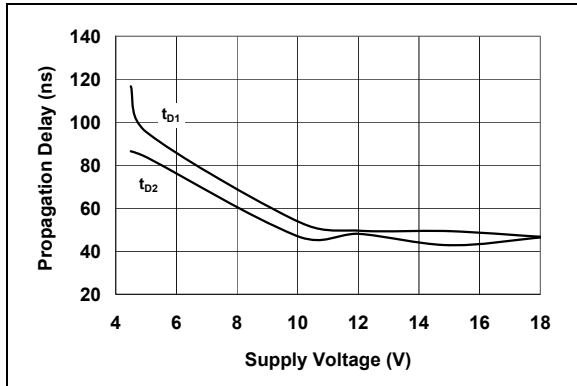


**FIGURE 2-6:** Propagation Delay vs. Input Amplitude.

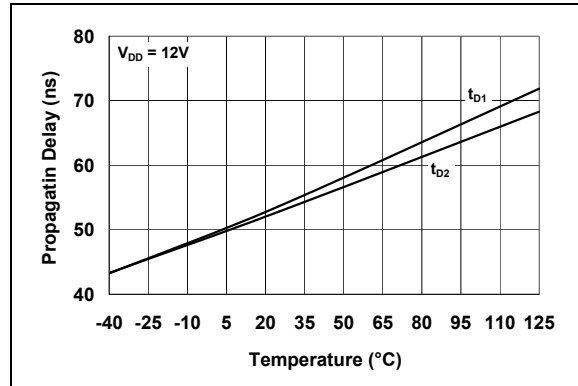
# MCP14E3/MCP14E4/MCP14E5

## Typical Performance Curves (Continued)

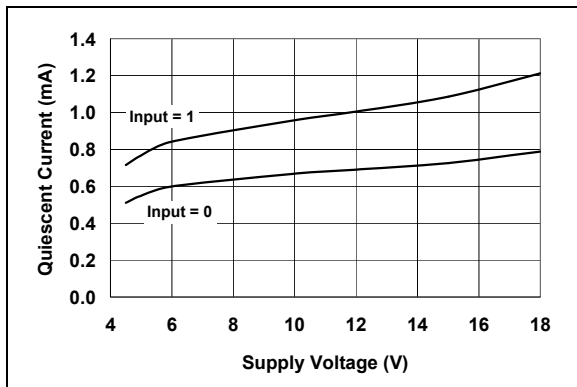
Note: Unless otherwise indicated,  $T_A = +25^\circ\text{C}$  with  $4.5\text{V} \leq V_{DD} \leq 18\text{V}$ .



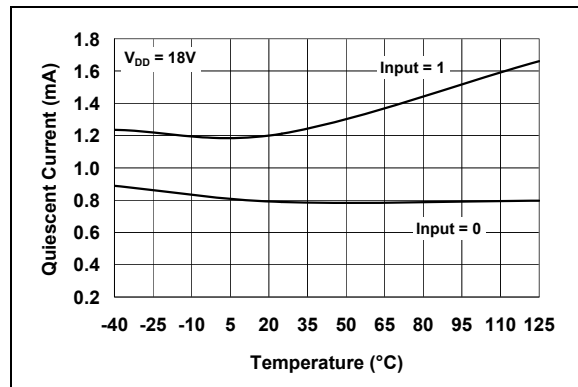
**FIGURE 2-7:** Propagation Delay Time vs. Supply Voltage.



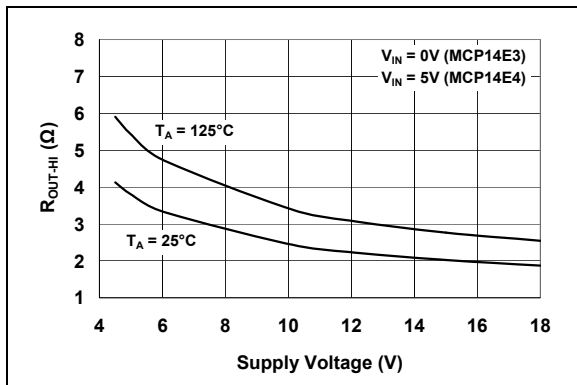
**FIGURE 2-10:** Propagation Delay Time vs. Temperature.



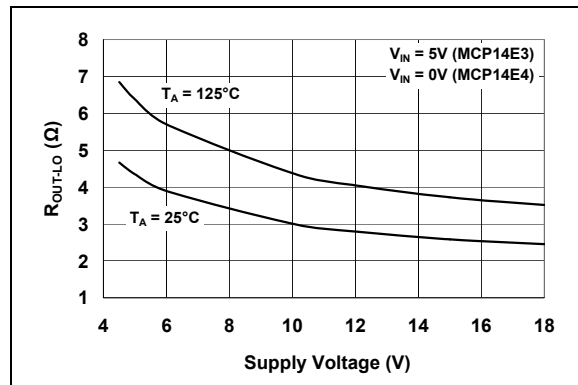
**FIGURE 2-8:** Quiescent Current vs. Supply Voltage.



**FIGURE 2-11:** Quiescent Current vs. Temperature.



**FIGURE 2-9:** Output Resistance (Output High) vs. Supply Voltage.



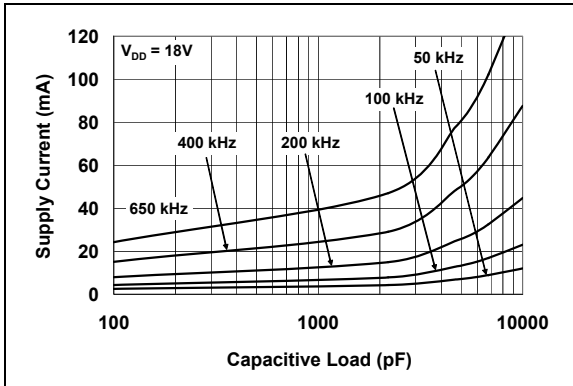
**FIGURE 2-12:** Output Resistance (Output Low) vs. Supply Voltage.



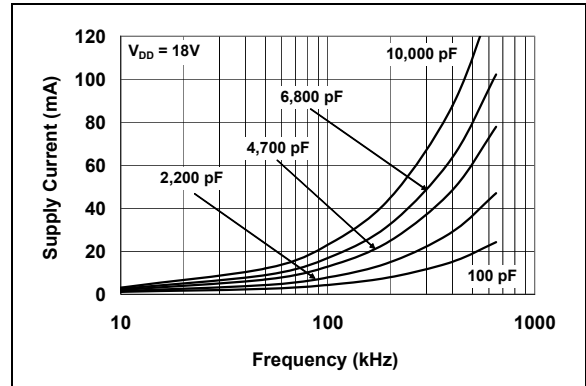
# MCP14E3/MCP14E4/MCP14E5

## Typical Performance Curves (Continued)

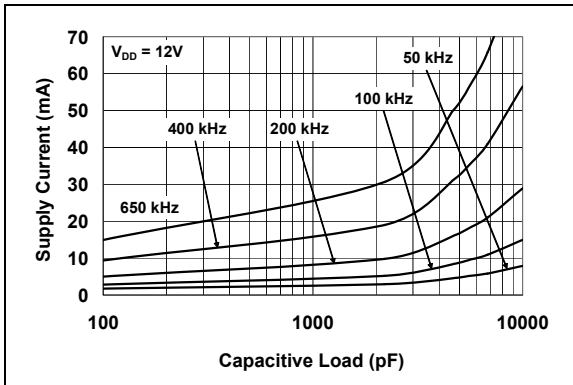
Note: Unless otherwise indicated,  $T_A = +25^\circ\text{C}$  with  $4.5\text{V} \leq V_{DD} \leq 18\text{V}$ .



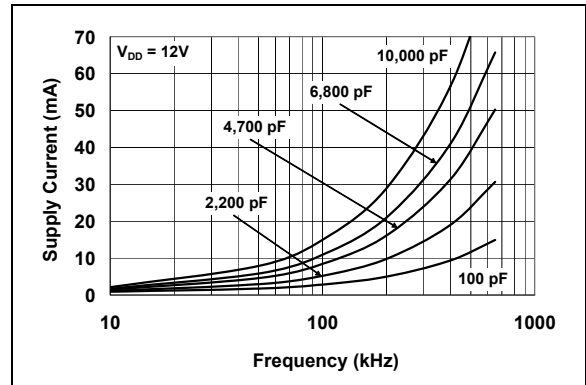
**FIGURE 2-13:** Supply Current vs. Capacitive Load.



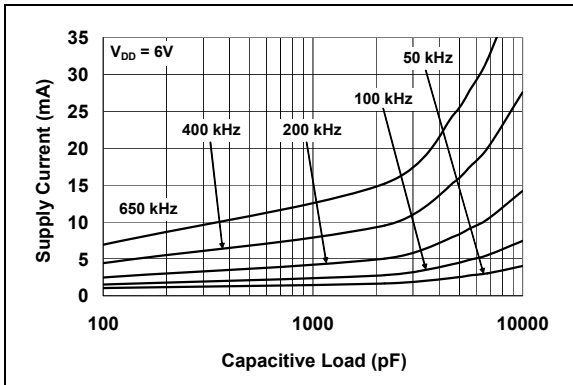
**FIGURE 2-16:** Supply Current vs. Frequency.



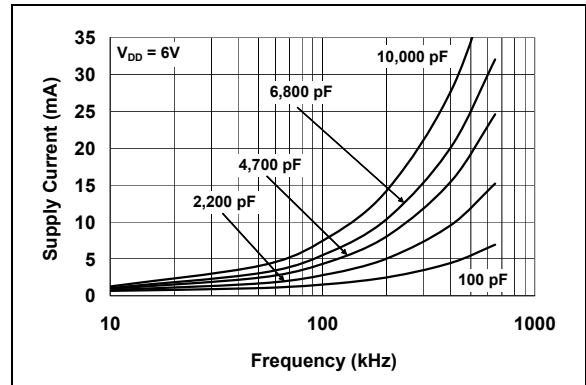
**FIGURE 2-14:** Supply Current vs. Capacitive Load.



**FIGURE 2-17:** Supply Current vs. Frequency.



**FIGURE 2-15:** Supply Current vs. Capacitive Load.

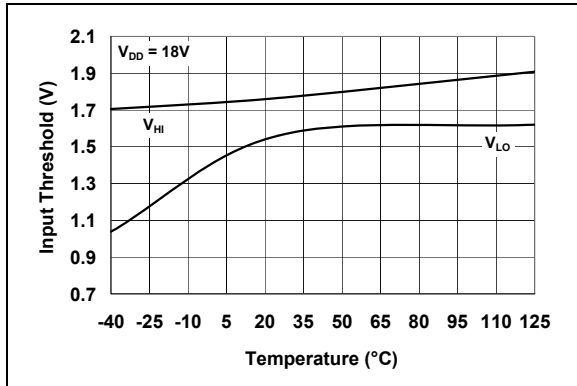


**FIGURE 2-18:** Supply Current vs. Frequency.

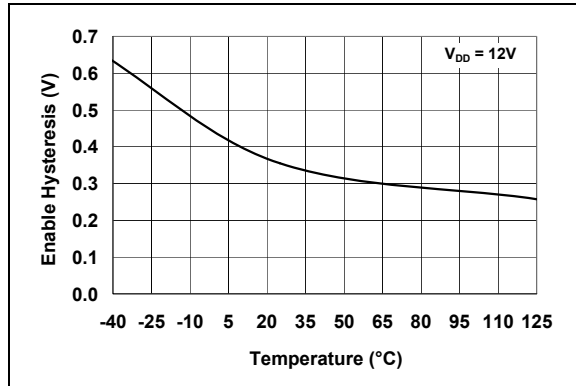
# MCP14E3/MCP14E4/MCP14E5

## Typical Performance Curves (Continued)

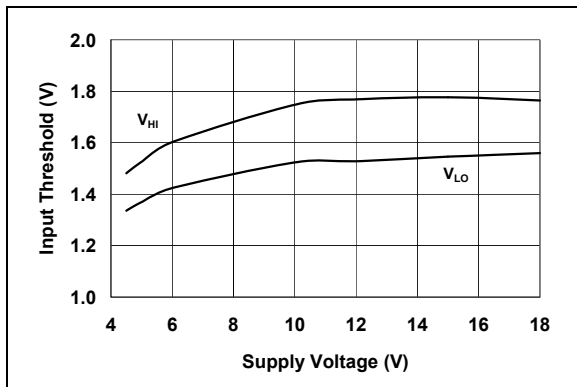
Note: Unless otherwise indicated,  $T_A = +25^\circ\text{C}$  with  $4.5\text{V} \leq V_{DD} \leq 18\text{V}$ .



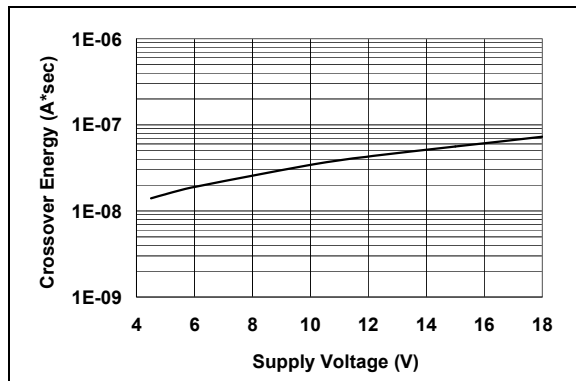
**FIGURE 2-19:** Input Threshold vs. Temperature.



**FIGURE 2-22:** Enable Hysteresis vs. Temperature.

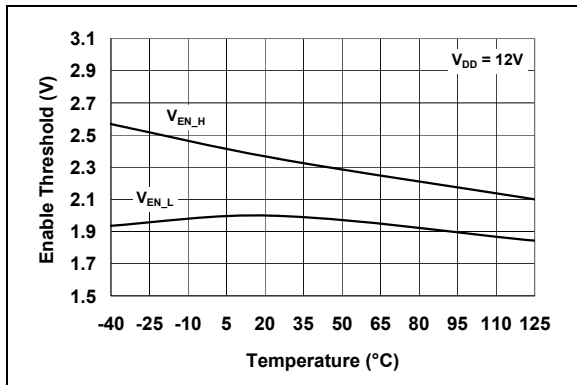


**FIGURE 2-20:** Input Threshold vs. Supply Voltage.



**Note:** The values on this graph represent the loss seen by both drivers in a package during one complete cycle. For a single driver, divide the stated value by 2. For a signal transition of a single driver, divide the state value by 4.

**FIGURE 2-23:** Crossover Energy vs. Supply Voltage.



**FIGURE 2-21:** Enable Threshold vs. Temperature.

# MCP14E3/MCP14E4/MCP14E5

## 3.0 PIN DESCRIPTIONS

The descriptions of the pins are listed in [Table 3-1](#).

**TABLE 3-1: PIN FUNCTION TABLE**

| 8-Pin PDIP, SOIC | 8-Pin 6x5 DFN | Symbol          | Description       |
|------------------|---------------|-----------------|-------------------|
| 1                | 1             | ENB_A           | Output A Enable   |
| 2                | 2             | IN A            | Input A           |
| 3                | 3             | GND             | Ground            |
| 4                | 4             | IN B            | Input B           |
| 5                | 5             | OUT B           | Output B          |
| 6                | 6             | V <sub>DD</sub> | Supply Input      |
| 7                | 7             | OUT A           | Output A          |
| 8                | 8             | ENB_B           | Output B Enable   |
| —                | PAD           | NC              | Exposed Metal Pad |

**Note:** Duplicate pins must be connected for proper operation.

### 3.1 Control Inputs A and B

The MOSFET driver inputs are a high-impedance TTL/CMOS compatible input. The inputs also have hysteresis between the high and low input levels, allowing them to be driven from slow rising and falling signals and to provide noise immunity.

### 3.2 Outputs A and B

Outputs A and B are CMOS push-pull outputs that are capable of sourcing and sinking 4.0A of peak current (V<sub>DD</sub> = 18V). The low output impedance ensures the gate of the MOSFET will stay in the intended state even during large transients. These outputs also have a reverse latch-up rating of 1.5A.

### 3.3 Supply Input (V<sub>DD</sub>)

V<sub>DD</sub> is the bias supply input for the MOSFET driver and has a voltage range of 4.5V to 18V. This input must be decoupled to ground with a local ceramic capacitor. This bypass capacitor provides a localized low-impedance path for the peak currents that are to be provided to the load.

### 3.4 Ground (GND)

Ground is the device return pin. The ground pin(s) should have a low impedance connection to the bias supply source return. High peak currents will flow out the ground pin(s) when the capacitive load is being discharged.

### 3.5 Enable A (ENB\_A)

The ENB\_A pin is the enable control for Output A. This enable pin is internally pulled up to V<sub>DD</sub> for active high operation and can be left floating for standard operation. When the ENB\_A pin is pulled below the enable pin Low Level Input Voltage (V<sub>EN\_L</sub>), Output A will be in the off state regardless of the input pin state.

### 3.6 Enable B (ENB\_B)

The ENB\_B pin is the enable control for Output B. This enable pin is internally pulled up to V<sub>DD</sub> for active high operation and can be left floating for standard operation. When the ENB\_B pin is pulled below the enable pin Low-Level Input Voltage (V<sub>EN\_L</sub>), Output B will be in the off state regardless of the input pin state.

### 3.7 DFN Exposed Pad

The exposed metal pad of the DFN package is not internally connected to any potential. Therefore, this pad can be connected to a ground plane or other copper plane on a printed circuit board to aid in heat removal from the package.

# MCP14E3/MCP14E4/MCP14E5

## 4.0 APPLICATION INFORMATION

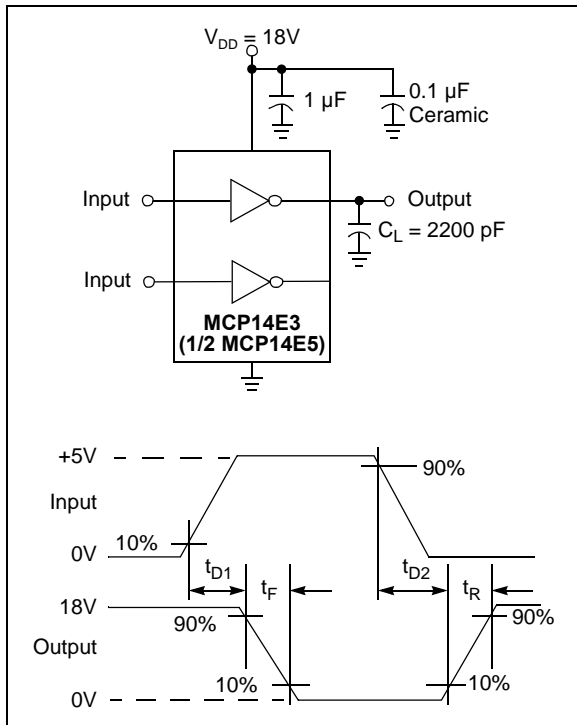
### 4.1 General Information

MOSFET drivers are high-speed, high current devices which are intended to source/sink high peak currents to charge/discharge the gate capacitance of external MOSFETs or IGBTs. In high frequency switching power supplies, the PWM controller may not have the drive capability to directly drive the power MOSFET. A MOSFET driver like the MCP14E3/MCP14E4/MCP14E5 family can be used to provide additional source/sink current capability.

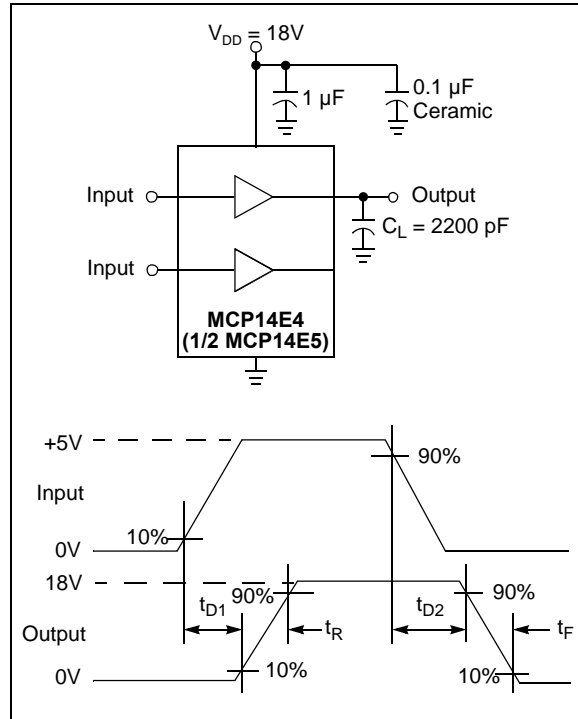
An additional degree of control has been added to the MCP14E3/MCP14E4/MCP14E5 family. There are separate enable functions for each driver that allow for the immediate termination of the output pulse regardless of the state of the input signal.

### 4.2 MOSFET Driver Timing

The ability of a MOSFET driver to transition from a fully off state to a fully on state are characterized by the drivers rise time ( $t_R$ ), fall time ( $t_F$ ), and propagation delays ( $t_{D1}$  and  $t_{D2}$ ). The MCP14E3/MCP14E4/MCP14E5 family of drivers can typically charge and discharge a 2200 pF load capacitance in 15 ns along with a typical matched propagation delay of 50 ns. [Figure 4-1](#) and [Figure 4-2](#) show the test circuit and timing waveform used to verify the MCP14E3/MCP14E4/MCP14E5 timing.



**FIGURE 4-1:** Inverting Driver Timing Waveform.



**FIGURE 4-2:** Non-Inverting Driver Timing Waveform.

### 4.3 Enable Function

The ENB\_A and ENB\_B enable pins allow for independent control of OUT A and OUT B respectively. They are active high and are internally pulled up to  $V_{DD}$  so that the default state is to enable the driver. These pins can be left floating for normal operation.

When an enable pin voltage is above the enable pin high threshold voltage,  $V_{EN\_H}$  (2.4V typical), that driver output is enabled and allowed to react to changes in the INPUT pin voltage state. Likewise, when the enable pin voltage falls below the enable pin low threshold voltage,  $V_{EN\_L}$  (2.0V typical), that driver output is disabled and does not respond to the changes in the INPUT pin voltage state. When the driver is disabled, the output goes to a low state. Refer to [Table 4-1](#) for enable pin logic. The threshold voltages of the enable function are compatible with logic levels. Hysteresis is provided to help increase the noise immunity of the enable function, avoiding false triggers of the enable signal during driver switching. For robust designs, it is recommended that the slew rate of the enable pin signal be greater than 1 V/ns.

There are propagation delays associated with the driver receiving an enable signal and the output reacting. These propagation delays,  $t_{D3}$  and  $t_{D4}$ , are graphically represented in [Figure 4-3](#).

# MCP14E3/MCP14E4/MCP14E5

TABLE 4-1: ENABLE PIN LOGIC

| ENB_A | ENB_B | IN A | IN B | MCP14E3 |       | MCP14E4 |       | MCP14E5 |       |
|-------|-------|------|------|---------|-------|---------|-------|---------|-------|
|       |       |      |      | OUT A   | OUT B | OUT A   | OUT B | OUT A   | OUT B |
| H     | H     | H    | H    | L       | L     | H       | H     | L       | H     |
| H     | H     | H    | L    | L       | H     | H       | L     | L       | L     |
| H     | H     | L    | H    | H       | L     | L       | H     | H       | H     |
| H     | H     | L    | L    | H       | H     | L       | L     | H       | L     |
| L     | L     | X    | X    | L       | L     | L       | L     | L       | L     |

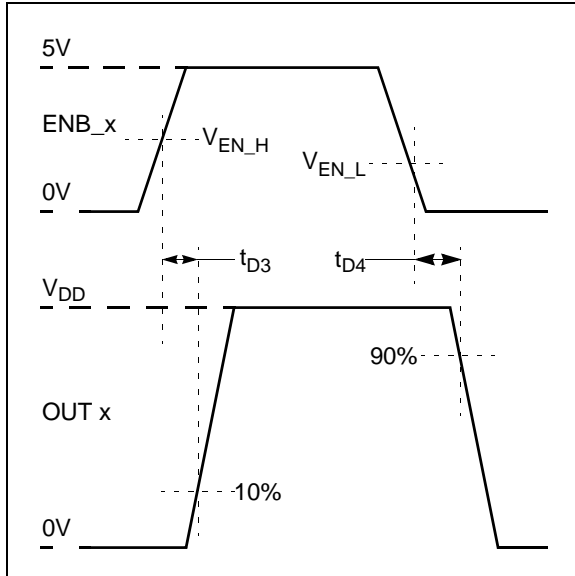


FIGURE 4-3: Enable Timing Waveform.

## 4.4 Decoupling Capacitors

Careful layout and decoupling capacitors are highly recommended when using MOSFET drivers. Large currents are required to charge and discharge capacitive loads quickly. For example, 2.5A are needed to charge a 2200 pF load with 18V in 16 ns.

To operate the MOSFET driver over a wide frequency range with low supply impedance, a ceramic and low ESR film capacitor are recommended to be placed in parallel between the driver V<sub>DD</sub> and GND. A 1.0 μF low ESR film capacitor and a 0.1 μF ceramic capacitor should be used. These capacitors should be placed close to the driver to minimize circuit board parasitics and provide a local source for the required current.

## 4.5 PCB Layout Considerations

Proper PCB layout is important in a high current, fast switching circuit to provide proper device operation and robustness of design. PCB trace loop area and inductance should be minimized by the use of ground planes or trace under MOSFET gate drive signals, separate analog and power grounds, and local driver decoupling.

Placing a ground plane beneath the MCP14E3/MCP14E4/MCP14E5 will help as a radiated noise shield as well as providing some heat sinking for power dissipated within the device.

## 4.6 Power Dissipation

The total internal power dissipation in a MOSFET driver is the summation of three separate power dissipation elements.

EQUATION 4-1:

$$P_T = P_L + P_Q + P_{CC}$$

Where:

|                 |   |                             |
|-----------------|---|-----------------------------|
| P <sub>T</sub>  | = | Total power dissipation     |
| P <sub>L</sub>  | = | Load power dissipation      |
| P <sub>Q</sub>  | = | Quiescent power dissipation |
| P <sub>CC</sub> | = | Operating power dissipation |

### 4.6.1 CAPACITIVE LOAD DISSIPATION

The power dissipation caused by a capacitive load is a direct function of frequency, total capacitive load, and supply voltage. The power lost in the MOSFET driver for a complete charging and discharging cycle of a MOSFET is:

EQUATION 4-2:

$$P_L = f \times C_T \times V_{DD}^2$$

Where:

|                 |   |                              |
|-----------------|---|------------------------------|
| f               | = | Switching frequency          |
| C <sub>T</sub>  | = | Total load capacitance       |
| V <sub>DD</sub> | = | MOSFET driver supply voltage |

# MCP14E3/MCP14E4/MCP14E5

---

## 4.6.2 QUIESCENT POWER DISSIPATION

The power dissipation associated with the quiescent current draw of the MCP14E3/MCP14E4/MCP14E5 depends upon the state of the input and enable pins. Refer to the DC Characteristic table for the quiescent current draw for specific combinations of input and enable pin states. The quiescent power dissipation is:

### EQUATION 4-3:

$$P_Q = (I_{QH} \times D + I_{QL} \times (1 - D)) \times V_{DD}$$

Where:

|          |   |                                     |
|----------|---|-------------------------------------|
| $I_{QH}$ | = | Quiescent current in the high state |
| $D$      | = | Duty cycle                          |
| $I_{QL}$ | = | Quiescent current in the low state  |
| $V_{DD}$ | = | MOSFET driver supply voltage        |

## 4.6.3 OPERATING POWER DISSIPATION

The operating power dissipation occurs each time the MOSFET driver output transitions because for a very short period of time both MOSFETs in the output stage are on simultaneously. This cross-conduction current leads to a power dissipation describes as:

### EQUATION 4-4:

$$P_{CC} = CC \times f \times V_{DD}$$

Where:

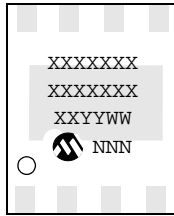
|          |   |                                   |
|----------|---|-----------------------------------|
| $CC$     | = | Cross-conduction constant (A*sec) |
| $f$      | = | Switching frequency               |
| $V_{DD}$ | = | MOSFET driver supply voltage      |

# MCP14E3/MCP14E4/MCP14E5

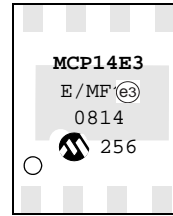
## 5.0 PACKAGING INFORMATION

### 5.1 Package Marking Information (Not to Scale)

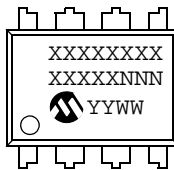
8-Lead DFN-S (6x5)



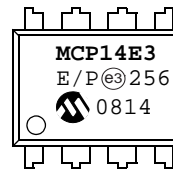
Example:



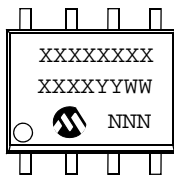
8-Lead PDIP (300 mil)



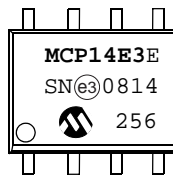
Example:



8-Lead SOIC (150 mil)



Example:

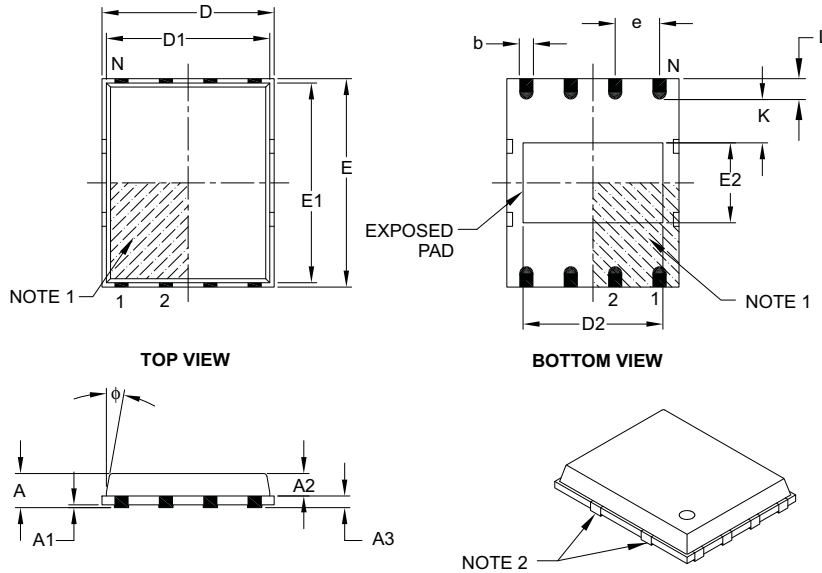


|                |   |  |
|----------------|---|--|
| <b>Legend:</b> | XX...X  | Customer-specific information  |
|                | Y   | Year code (last digit of calendar year)  |
|                | YY  | Year code (last 2 digits of calendar year)   |
|                | WW  | Week code (week of January 1 is week '01')   |
|                | NNN   | Alphanumeric traceability code   |
|                | (e3)  | Pb-free JEDEC designator for Matte Tin (Sn)  |
|                | *   | This package is Pb-free. The Pb-free JEDEC designator (e3) can be found on the outer packaging for this package. |
| <b>Note:</b>   | In the event the full Microchip part number cannot be marked on one line, it will be carried over to the next line, thus limiting the number of available characters for customer-specific information. |  |

# MCP14E3/MCP14E4/MCP14E5

## 8-Lead Plastic Dual Flat, No Lead Package (MF) – 6x5 mm Body [DFN-S] PUNCH SINGULATED

**Note:** For the most current package drawings, please see the Microchip Packaging Specification located at <http://www.microchip.com/packaging>



| Dimension Limits         | Units  | MILLIMETERS |      |      |
|--------------------------|--------|-------------|------|------|
|                          |        | MIN         | NOM  | MAX  |
| Number of Pins           | N      | 8           |      |      |
| Pitch                    | e      | 1.27 BSC    |      |      |
| Overall Height           | A      | –           | 0.85 | 1.00 |
| Molded Package Thickness | A2     | –           | 0.65 | 0.80 |
| Standoff                 | A1     | 0.00        | 0.01 | 0.05 |
| Base Thickness           | A3     | 0.20 REF    |      |      |
| Overall Length           | D      | 4.92 BSC    |      |      |
| Molded Package Length    | D1     | 4.67 BSC    |      |      |
| Exposed Pad Length       | D2     | 3.85        | 4.00 | 4.15 |
| Overall Width            | E      | 5.99 BSC    |      |      |
| Molded Package Width     | E1     | 5.74 BSC    |      |      |
| Exposed Pad Width        | E2     | 2.16        | 2.31 | 2.46 |
| Contact Width            | b      | 0.35        | 0.40 | 0.47 |
| Contact Length           | L      | 0.50        | 0.60 | 0.75 |
| Contact-to-Exposed Pad   | K      | 0.20        | –    | –    |
| Model Draft Angle Top    | $\phi$ | –           | –    | 12°  |

**Notes:**

- Pin 1 visual index feature may vary, but must be located within the hatched area.
- Package may have one or more exposed tie bars at ends.
- Dimensioning and tolerancing per ASME Y14.5M.

BSC: Basic Dimension. Theoretically exact value shown without tolerances.

REF: Reference Dimension, usually without tolerance, for information purposes only.

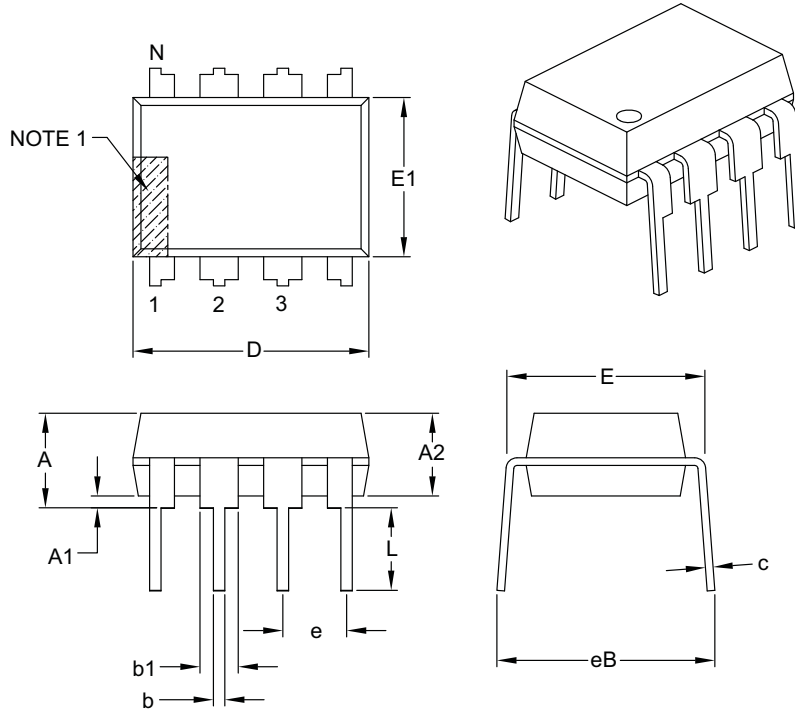
Microchip Technology Drawing C04-113B



# MCP14E3/MCP14E4/MCP14E5

## 8-Lead Plastic Dual In-Line (P) – 300 mil Body [PDIP]

**Note:** For the most current package drawings, please see the Microchip Packaging Specification located at <http://www.microchip.com/packaging>



| Dimension Limits           | Units | INCHES   |      |      |
|----------------------------|-------|----------|------|------|
|                            |       | MIN      | NOM  | MAX  |
| Number of Pins             | N     | 8        |      |      |
| Pitch                      | e     | .100 BSC |      |      |
| Top to Seating Plane       | A     | –        | –    | .210 |
| Molded Package Thickness   | A2    | .115     | .130 | .195 |
| Base to Seating Plane      | A1    | .015     | –    | –    |
| Shoulder to Shoulder Width | E     | .290     | .310 | .325 |
| Molded Package Width       | E1    | .240     | .250 | .280 |
| Overall Length             | D     | .348     | .365 | .400 |
| Tip to Seating Plane       | L     | .115     | .130 | .150 |
| Lead Thickness             | c     | .008     | .010 | .015 |
| Upper Lead Width           | b1    | .040     | .060 | .070 |
| Lower Lead Width           | b     | .014     | .018 | .022 |
| Overall Row Spacing §      | eB    | –        | –    | .430 |

**Notes:**

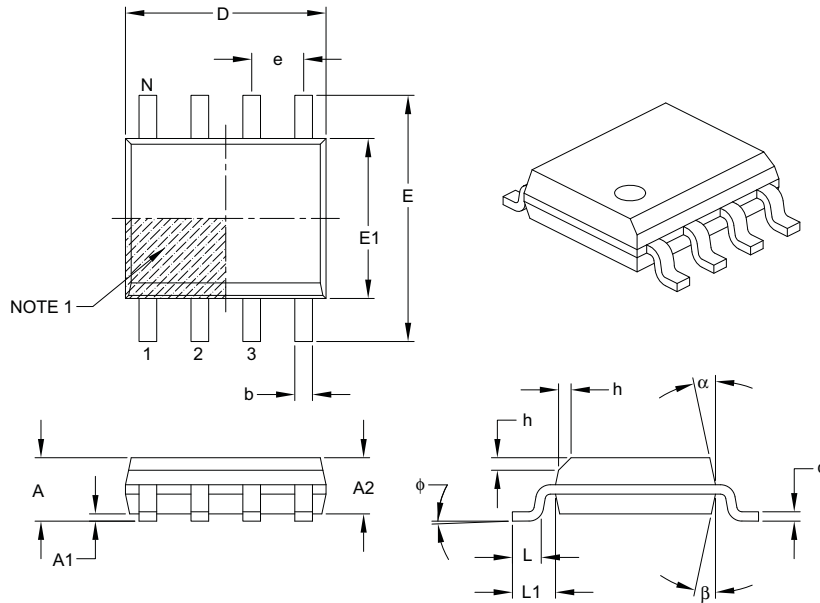
- Pin 1 visual index feature may vary, but must be located with the hatched area.
- § Significant Characteristic.
- Dimensions D and E1 do not include mold flash or protrusions. Mold flash or protrusions shall not exceed .010" per side.
- Dimensioning and tolerancing per ASME Y14.5M.  
BSC: Basic Dimension. Theoretically exact value shown without tolerances.

Microchip Technology Drawing C04-018B

# MCP14E3/MCP14E4/MCP14E5

## 8-Lead Plastic Small Outline (SN) – Narrow, 3.90 mm Body [SOIC]

**Note:** For the most current package drawings, please see the Microchip Packaging Specification located at <http://www.microchip.com/packaging>



| Dimension Limits         | Units    | MILLIMETERS |     |      |
|--------------------------|----------|-------------|-----|------|
|                          |          | MIN         | NOM | MAX  |
| Number of Pins           | N        | 8           |     |      |
| Pitch                    | e        | 1.27 BSC    |     |      |
| Overall Height           | A        | –           | –   | 1.75 |
| Molded Package Thickness | A2       | 1.25        | –   | –    |
| Standoff §               | A1       | 0.10        | –   | 0.25 |
| Overall Width            | E        | 6.00 BSC    |     |      |
| Molded Package Width     | E1       | 3.90 BSC    |     |      |
| Overall Length           | D        | 4.90 BSC    |     |      |
| Chamfer (optional)       | h        | 0.25        | –   | 0.50 |
| Foot Length              | L        | 0.40        | –   | 1.27 |
| Footprint                | L1       | 1.04 REF    |     |      |
| Foot Angle               | $\phi$   | 0°          | –   | 8°   |
| Lead Thickness           | c        | 0.17        | –   | 0.25 |
| Lead Width               | b        | 0.31        | –   | 0.51 |
| Mold Draft Angle Top     | $\alpha$ | 5°          | –   | 15°  |
| Mold Draft Angle Bottom  | $\beta$  | 5°          | –   | 15°  |

**Notes:**

- Pin 1 visual index feature may vary, but must be located within the hatched area.
- § Significant Characteristic.
- Dimensions D and E1 do not include mold flash or protrusions. Mold flash or protrusions shall not exceed 0.15 mm per side.
- Dimensioning and tolerancing per ASME Y14.5M.

BSC: Basic Dimension. Theoretically exact value shown without tolerances.

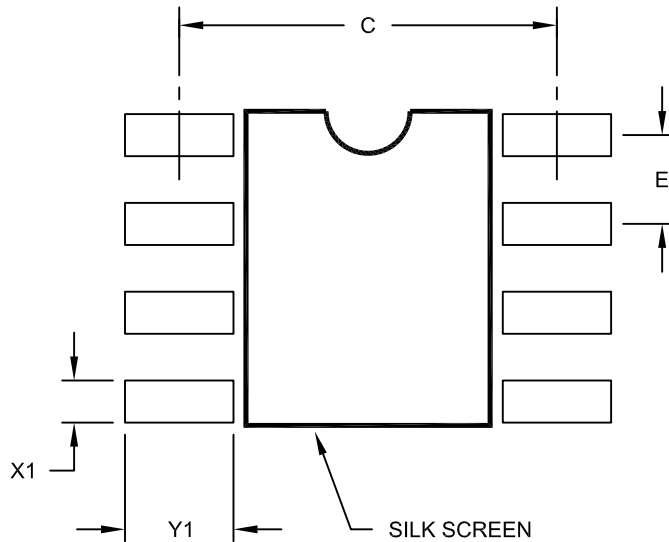
REF: Reference Dimension, usually without tolerance, for information purposes only.

Microchip Technology Drawing C04-057B

# MCP14E3/MCP14E4/MCP14E5

## 8-Lead Plastic Small Outline (SN) – Narrow, 3.90 mm Body [SOIC]

**Note:** For the most current package drawings, please see the Microchip Packaging Specification located at <http://www.microchip.com/packaging>



RECOMMENDED LAND PATTERN

| Dimension Limits        | Units | MILLIMETERS |      |      |
|-------------------------|-------|-------------|------|------|
|                         |       | MIN         | NOM  | MAX  |
| Contact Pitch           | E     | 1.27 BSC    |      |      |
| Contact Pad Spacing     | C     |             | 5.40 |      |
| Contact Pad Width (X8)  | X1    |             |      | 0.60 |
| Contact Pad Length (X8) | Y1    |             |      | 1.55 |

Notes:

1. Dimensioning and tolerancing per ASME Y14.5M

BSC: Basic Dimension. Theoretically exact value shown without tolerances.

Microchip Technology Drawing No. C04-2057A

# MCP14E3/MCP14E4/MCP14E5

---

NOTES:

## APPENDIX A: REVISION HISTORY

### Revision B (April 2008)

The following is the list of modifications:

1. Correct examples in Product identification System page.

### Revision A (September 2007)

- Original Release of this Document.

# MCP14E3/MCP14E4/MCP14E5

---

NOTES:

# MCP14E3/MCP14E4/MCP14E5

## PRODUCT IDENTIFICATION SYSTEM

To order or obtain information, e.g., on pricing or delivery, refer to the factory or the listed sales office.

| <u>PART NO.</u>  | X   | XX  | Examples:  |
|--|---|---|--|
| Device   | Temperature Range                             | Package   |  |
| <p>Device:</p> <p>MCP14E3: 4.0A Dual MOSFET Driver, Inverting<br/> MCP14E3T: 4.0A Dual MOSFET Driver, Inverting<br/> Tape and Reel</p> <p>MCP14E4: 4.0A Dual MOSFET Driver, Non-Inverting<br/> MCP14E4T: 4.0A Dual MOSFET Driver, Non-Inverting<br/> Tape and Reel</p> <p>MCP14E5: 4.0A Dual MOSFET Driver, Complementary<br/> MCP14E5T: 4.0A Dual MOSFET Driver, Complementary<br/> Tape and Reel</p> | <p>Temperature Range: E = -40°C to +125°C</p> | <p>Package: *</p> <p>MF = Dual, Flat, No-Lead (6x5 mm Body), 8-lead<br/> P = Plastic DIP, (300 mil body), 8-lead<br/> SN = Plastic SOIC (150 mil Body), 8-Lead</p> <p>* All package offerings are Pb Free (Lead Free)</p> | <p>a) MCP14E3-E/MF: 4.0A Dual Inverting MOSFET Driver, 8LD DFN package.</p> <p>b) MCP14E3-E/P: 4.0A Dual Inverting MOSFET Driver, 8LD PDIP package.</p> <p>c) MCP14E3-E/SN: 4.0A Dual Inverting MOSFET Driver, 8LD SOIC package.</p><br><p>a) MCP14E4-E/MF: 4.0A Dual Non-Inverting MOSFET Driver, 8LD DFN package.</p> <p>b) MCP14E4-E/P: 4.0A Dual Non-Inverting MOSFET Driver, 8LD PDIP package.</p> <p>c) MCP14E4T-E/SN: Tape and Reel, 4.0A Dual Non-Inverting MOSFET Driver, 8LD SOIC package.</p><br><p>a) MCP14E5T-E/MF: Tape and Reel, 4.0A Dual Complementary MOSFET Driver, 8LD DFN package.</p> <p>b) MCP14E5-E/P: 4.0A Dual Complementary MOSFET Driver, 8LD PDIP package.</p> <p>c) MCP14E5-E/SN: 4.0A Dual Complementary MOSFET Driver, 8LD SOIC package.</p> |

# MCP14E3/MCP14E4/MCP14E5

---

NOTES:



---

**Note the following details of the code protection feature on Microchip devices:**

- Microchip products meet the specification contained in their particular Microchip Data Sheet.
- Microchip believes that its family of products is one of the most secure families of its kind on the market today, when used in the intended manner and under normal conditions.
- There are dishonest and possibly illegal methods used to breach the code protection feature. All of these methods, to our knowledge, require using the Microchip products in a manner outside the operating specifications contained in Microchip's Data Sheets. Most likely, the person doing so is engaged in theft of intellectual property.
- Microchip is willing to work with the customer who is concerned about the integrity of their code.
- Neither Microchip nor any other semiconductor manufacturer can guarantee the security of their code. Code protection does not mean that we are guaranteeing the product as “unbreakable.”

Code protection is constantly evolving. We at Microchip are committed to continuously improving the code protection features of our products. Attempts to break Microchip's code protection feature may be a violation of the Digital Millennium Copyright Act. If such acts allow unauthorized access to your software or other copyrighted work, you may have a right to sue for relief under that Act.

---

Information contained in this publication regarding device applications and the like is provided only for your convenience and may be superseded by updates. It is your responsibility to ensure that your application meets with your specifications. MICROCHIP MAKES NO REPRESENTATIONS OR WARRANTIES OF ANY KIND WHETHER EXPRESS OR IMPLIED, WRITTEN OR ORAL, STATUTORY OR OTHERWISE, RELATED TO THE INFORMATION, INCLUDING BUT NOT LIMITED TO ITS CONDITION, QUALITY, PERFORMANCE, MERCHANTABILITY OR FITNESS FOR PURPOSE. Microchip disclaims all liability arising from this information and its use. Use of Microchip devices in life support and/or safety applications is entirely at the buyer's risk, and the buyer agrees to defend, indemnify and hold harmless Microchip from any and all damages, claims, suits, or expenses resulting from such use. No licenses are conveyed, implicitly or otherwise, under any Microchip intellectual property rights.

**Trademarks**

The Microchip name and logo, the Microchip logo, Accuron, dsPIC, KEELOQ, KEELOQ logo, MPLAB, PIC, PICmicro, PICSTART, PRO MATE, rPIC and SmartShunt are registered trademarks of Microchip Technology Incorporated in the U.S.A. and other countries.

FilterLab, Linear Active Thermistor, MXDEV, MXLAB, SEEVAL, SmartSensor and The Embedded Control Solutions Company are registered trademarks of Microchip Technology Incorporated in the U.S.A.

Analog-for-the-Digital Age, Application Maestro, CodeGuard, dsPICDEM, dsPICDEM.net, dsPICworks, dsSPEAK, ECAN, ECONOMONITOR, FanSense, In-Circuit Serial Programming, ICSP, ICEPIC, Mindi, MiWi, MPASM, MPLAB Certified logo, MPLIB, MPLINK, mTouch, PICkit, PICDEM, PICDEM.net, PICtail, PIC<sup>32</sup> logo, PowerCal, PowerInfo, PowerMate, PowerTool, REAL ICE, rLAB, Select Mode, Total Endurance, UNI/O, WiperLock and ZENA are trademarks of Microchip Technology Incorporated in the U.S.A. and other countries.

SQTP is a service mark of Microchip Technology Incorporated in the U.S.A.

All other trademarks mentioned herein are property of their respective companies.

© 2008, Microchip Technology Incorporated, Printed in the U.S.A., All Rights Reserved.

 Printed on recycled paper.

**QUALITY MANAGEMENT SYSTEM**  
**CERTIFIED BY DNV**  
**== ISO/TS 16949:2002 ==**

*Microchip received ISO/TS-16949:2002 certification for its worldwide headquarters, design and wafer fabrication facilities in Chandler and Tempe, Arizona; Gresham, Oregon and design centers in California and India. The Company's quality system processes and procedures are for its PIC<sup>®</sup> MCUs and dsPIC<sup>®</sup> DSCs, KEELOQ<sup>®</sup> code hopping devices, Serial EEPROMs, microperipherals, nonvolatile memory and analog products. In addition, Microchip's quality system for the design and manufacture of development systems is ISO 9001:2000 certified.*



## WORLDWIDE SALES AND SERVICE

### AMERICAS

**Corporate Office**  
2355 West Chandler Blvd.  
Chandler, AZ 85224-6199  
Tel: 480-792-7200  
Fax: 480-792-7277  
Technical Support:  
<http://support.microchip.com>  
Web Address:  
[www.microchip.com](http://www.microchip.com)

**Atlanta**  
Duluth, GA  
Tel: 678-957-9614  
Fax: 678-957-1455

**Boston**  
Westborough, MA  
Tel: 774-760-0087  
Fax: 774-760-0088

**Chicago**  
Itasca, IL  
Tel: 630-285-0071  
Fax: 630-285-0075

**Dallas**  
Addison, TX  
Tel: 972-818-7423  
Fax: 972-818-2924

**Detroit**  
Farmington Hills, MI  
Tel: 248-538-2250  
Fax: 248-538-2260

**Kokomo**  
Kokomo, IN  
Tel: 765-864-8360  
Fax: 765-864-8387

**Los Angeles**  
Mission Viejo, CA  
Tel: 949-462-9523  
Fax: 949-462-9608

**Santa Clara**  
Santa Clara, CA  
Tel: 408-961-6444  
Fax: 408-961-6445

**Toronto**  
Mississauga, Ontario,  
Canada  
Tel: 905-673-0699  
Fax: 905-673-6509

### ASIA/PACIFIC

**Asia Pacific Office**  
Suites 3707-14, 37th Floor  
Tower 6, The Gateway  
Harbour City, Kowloon  
Hong Kong  
Tel: 852-2401-1200  
Fax: 852-2401-3431

**Australia - Sydney**  
Tel: 61-2-9868-6733  
Fax: 61-2-9868-6755

**China - Beijing**  
Tel: 86-10-8528-2100  
Fax: 86-10-8528-2104

**China - Chengdu**  
Tel: 86-28-8665-5511  
Fax: 86-28-8665-7889

**China - Hong Kong SAR**  
Tel: 852-2401-1200  
Fax: 852-2401-3431

**China - Nanjing**  
Tel: 86-25-8473-2460  
Fax: 86-25-8473-2470

**China - Qingdao**  
Tel: 86-532-8502-7355  
Fax: 86-532-8502-7205

**China - Shanghai**  
Tel: 86-21-5407-5533  
Fax: 86-21-5407-5066

**China - Shenyang**  
Tel: 86-24-2334-2829  
Fax: 86-24-2334-2393

**China - Shenzhen**  
Tel: 86-755-8203-2660  
Fax: 86-755-8203-1760

**China - Wuhan**  
Tel: 86-27-5980-5300  
Fax: 86-27-5980-5118

**China - Xiamen**  
Tel: 86-592-2388138  
Fax: 86-592-2388130

**China - Xian**  
Tel: 86-29-8833-7252  
Fax: 86-29-8833-7256

**China - Zhuhai**  
Tel: 86-756-3210040  
Fax: 86-756-3210049

### ASIA/PACIFIC

**India - Bangalore**  
Tel: 91-80-4182-8400  
Fax: 91-80-4182-8422

**India - New Delhi**  
Tel: 91-11-4160-8631  
Fax: 91-11-4160-8632

**India - Pune**  
Tel: 91-20-2566-1512  
Fax: 91-20-2566-1513

**Japan - Yokohama**  
Tel: 81-45-471- 6166  
Fax: 81-45-471-6122

**Korea - Daegu**  
Tel: 82-53-744-4301  
Fax: 82-53-744-4302

**Korea - Seoul**  
Tel: 82-2-554-7200  
Fax: 82-2-558-5932 or  
82-2-558-5934

**Malaysia - Kuala Lumpur**  
Tel: 60-3-6201-9857  
Fax: 60-3-6201-9859

**Malaysia - Penang**  
Tel: 60-4-227-8870  
Fax: 60-4-227-4068

**Philippines - Manila**  
Tel: 63-2-634-9065  
Fax: 63-2-634-9069

**Singapore**  
Tel: 65-6334-8870  
Fax: 65-6334-8850

**Taiwan - Hsin Chu**  
Tel: 886-3-572-9526  
Fax: 886-3-572-6459

**Taiwan - Kaohsiung**  
Tel: 886-7-536-4818  
Fax: 886-7-536-4803

**Taiwan - Taipei**  
Tel: 886-2-2500-6610  
Fax: 886-2-2508-0102

**Thailand - Bangkok**  
Tel: 66-2-694-1351  
Fax: 66-2-694-1350

### EUROPE

**Austria - Wels**  
Tel: 43-7242-2244-39  
Fax: 43-7242-2244-393

**Denmark - Copenhagen**  
Tel: 45-4450-2828  
Fax: 45-4485-2829

**France - Paris**  
Tel: 33-1-69-53-63-20  
Fax: 33-1-69-30-90-79

**Germany - Munich**  
Tel: 49-89-627-144-0  
Fax: 49-89-627-144-44

**Italy - Milan**  
Tel: 39-0331-742611  
Fax: 39-0331-466781

**Netherlands - Drunen**  
Tel: 31-416-690399  
Fax: 31-416-690340

**Spain - Madrid**  
Tel: 34-91-708-08-90  
Fax: 34-91-708-08-91

**UK - Wokingham**  
Tel: 44-118-921-5869  
Fax: 44-118-921-5820