

OPTO INTERRUPTER ITR

ITR8307**■ Features**

- Fast response time
- High sensitivity
- Cut-Off visible wavelength
- Thin
- Compact
- Pb free

■ Descriptions

ITR8307 is a light reflection switch which includes a GaAs IR-LED transmitter and a NPN photo-transistor with a high photosensitive receiver for short distance, operating in the infrared range. Both components are mounted side- by- side in a plastic package.

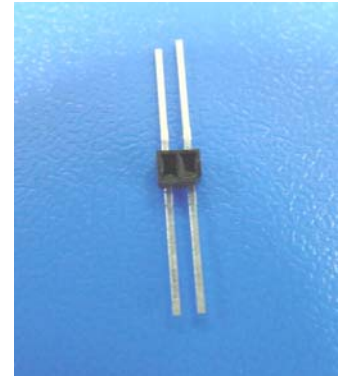
**■ Applications**

- Camera
- VCR
- Floppy disk driver
- Cassette type recorder
- Various microcomputer control equipment

■ Device Selection Guide

Device No.	Chip Material
IR	GaAs
PT	Silicon

OPTO INTERRUPTER ITR

ITR8307

Package Dimensions

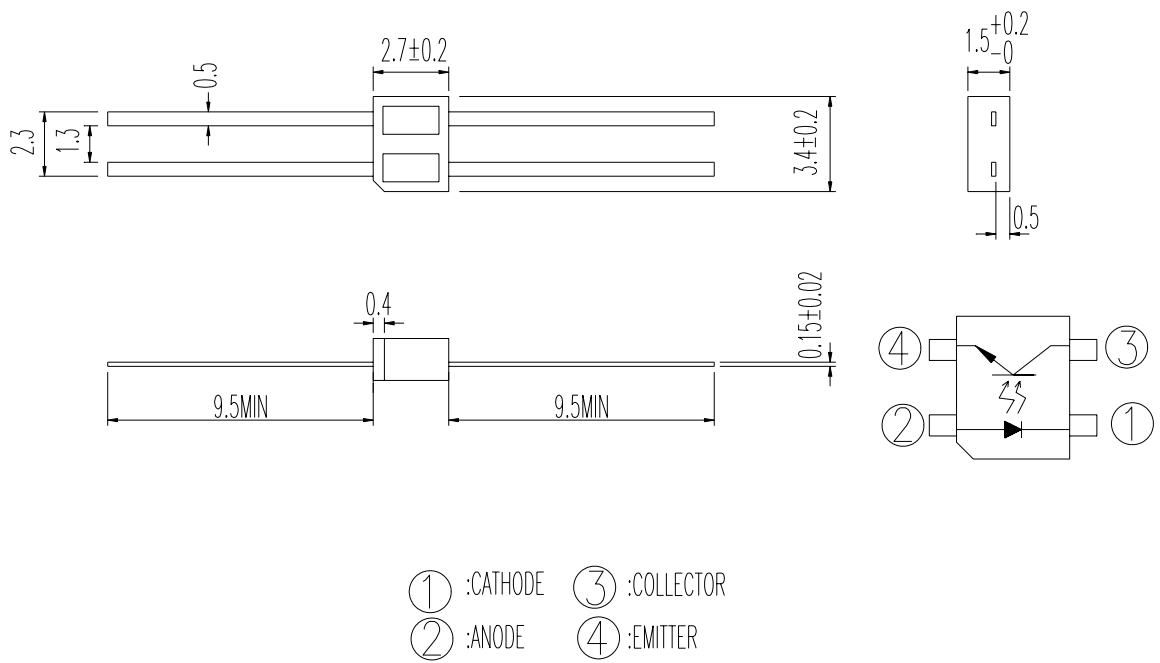

- Notes:** 1.All dimensions are in millimeters
2.Tolerances unless dimensions $\pm 0.25\text{mm}$

Absolute Maximum Ratings (Ta=25°C)

Parameter		Symbol	Ratings	Unit
Input	Power Dissipation at(or below) 25°C Free Air Temperature	Pd	75	mW
	Reverse Voltage	V _R	5	V
	Forward Current	I _F	50	mA
	Peak Forward Current (*1) Pulse width $\leq 100 \mu\text{s}$, Duty cycle=1%	I _{FP}	1	A
	Collector Power Dissipation	P _C	75	mW
Output	Collector Current	I _C	50	mA
	Collector-Emitter Voltage	B V _{CEO}	30	V
	Emitter-Collector Voltage	B V _{ECO}	5	V
	Operating Temperature	T _{opr}	-25~+85	°C
Storage Temperature	T _{stg}	-30~+90	°C	
Lead Soldering Temperature (*2)	T _{sol}	260	°C	

(* 1) $t_w=100 \mu\text{sec.}$, $T=10 \text{msec.}$ (* 2) $t=5 \text{Sec}$

OPTO INTERRUPTER ITR

Electro-Optical Characteristics (Ta=25°C)

ITR8307

Parameter		Symbol	Min.	Typ.	Max.	Unit	Conditions
Input	Forward Voltage	V_F	---	1.2	1.6	V	$I_F=20mA$
	Reverse Current	I_R	---	---	10	μA	$V_R=5V$
	Peak Wavelength	λ_p	---	940	---	nm	---
Output	Dark Current	I_{CEO}	---	---	100	nA	$V_{CE}=10V$
	C-E Saturation Voltage	$V_{CE(sat)}$	---	---	0.4	V	$I_C=2mA$ $E_e=1mW/cm^2$
Transfer Characteristics	Collector Current	$I_C(ON)$	0.1	-	---	mA	$V_{CE}=5V$, $I_F=20mA$
	Leakage Current	I_{CEOD}	---	---	1	μA	$V_{CE}=5V$ $I_F=20mA$
	Rise time	t_r	---	20	---	μsec	$V_{CE}=2V$ $I_C=100 \mu A$ $R_L=1K\Omega$
	Fall time	t_f	---	20	---	μsec	

Rank

Conditions : $I_F=20mA$ $V_{CE}=5V$

Unit: μA

Bin number	Min	Max
B	300	600
C	500	800

OPTO INTERRUPTER ITR

Typical Electrical/Optical/Characteristics Curves for IR

ITR8307

Fig.1 Forward Current vs. Ambient Temperature

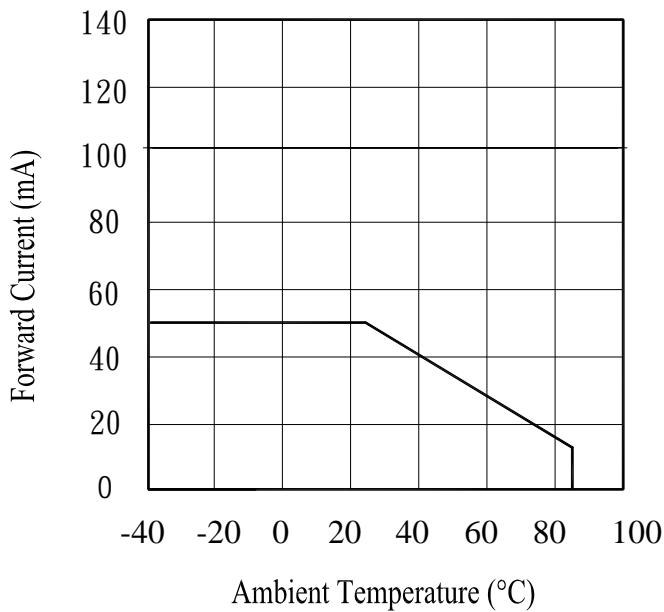

Fig.2 Spectral Distribution

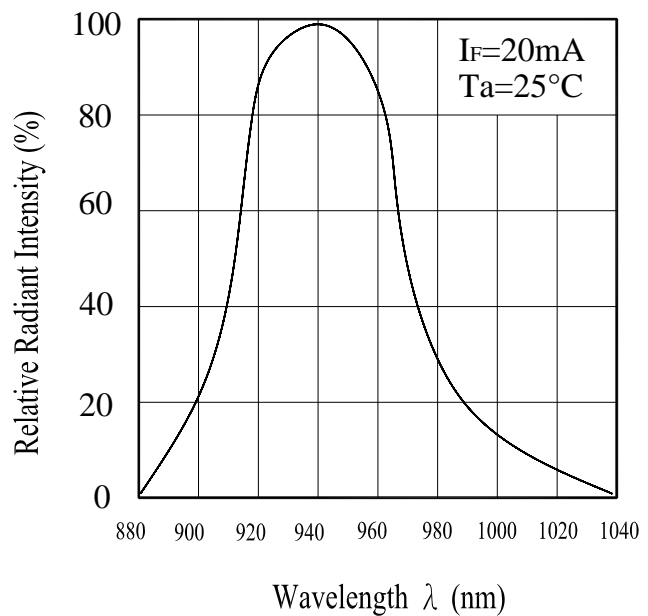

Fig.3 Peak Emission Wavelength vs. Ambient Temperature

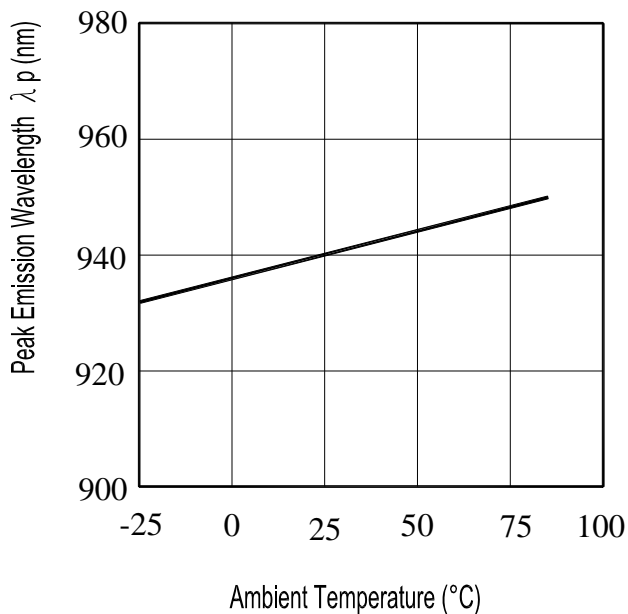
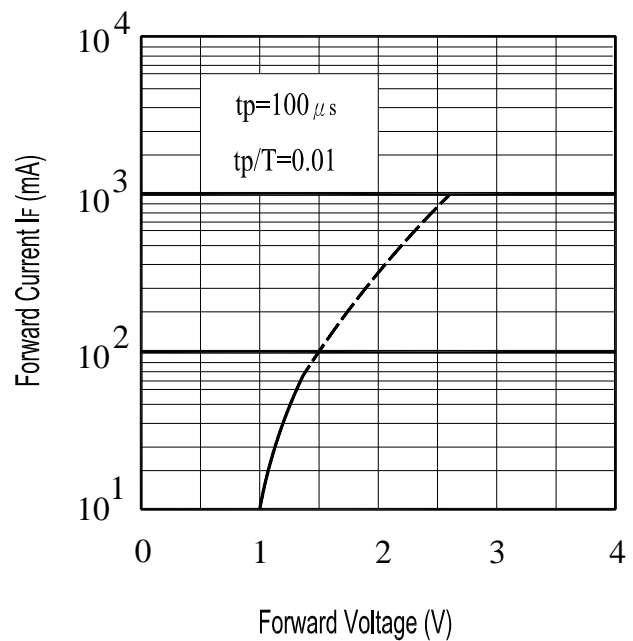

Fig.4 Forward Current vs. Forward Voltage



OPTO INTERRUPTER ITR

Fig.5 Relative Intensity vs.

Forward Current

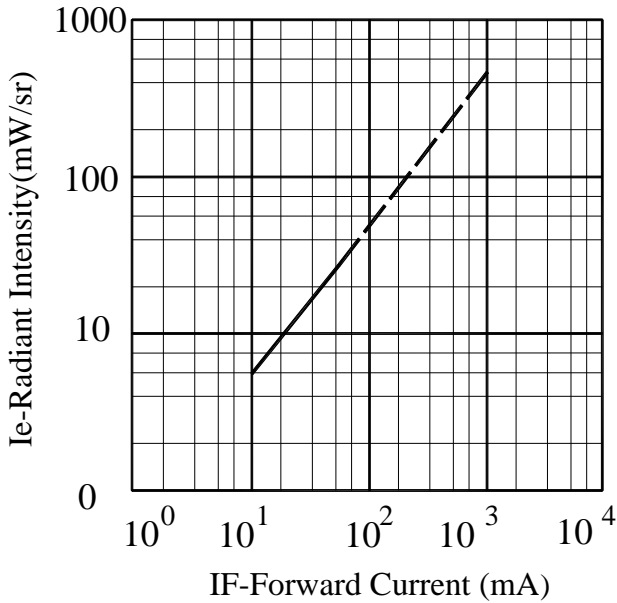

Fig.6 Relative Radiant Intensity vs. **ITR8307**

Angular Displacement

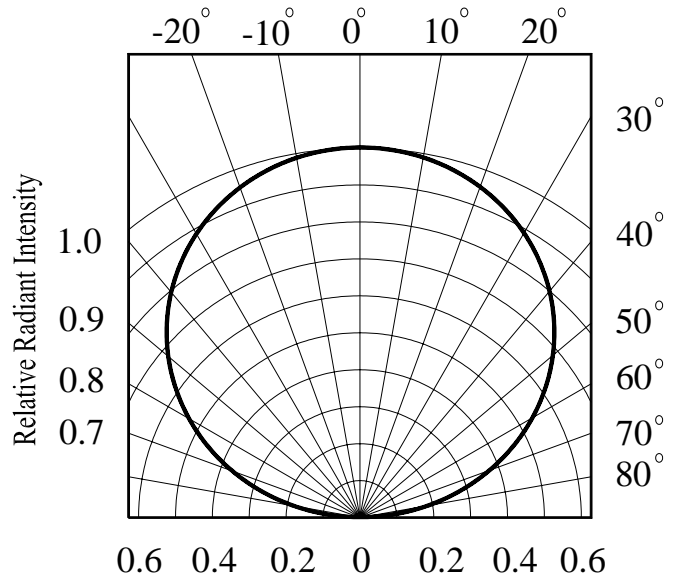

Fig.7 Relative Intensity vs.

Ambient Temperature(°C)

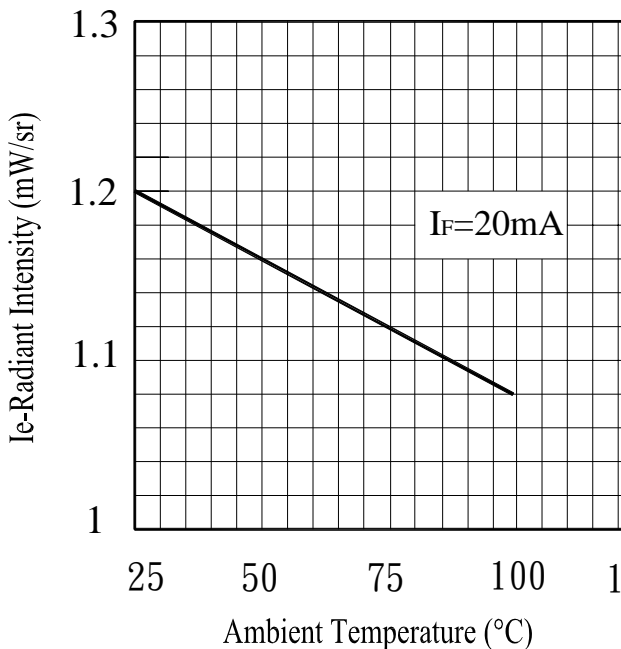
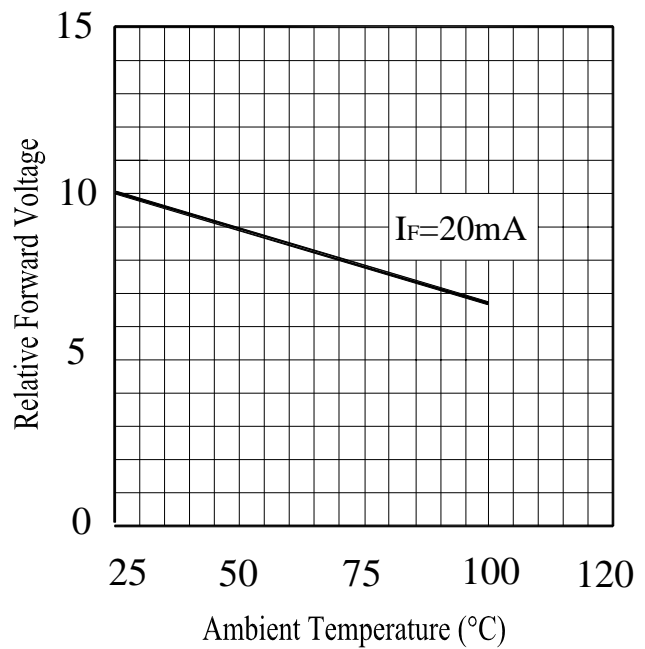

Fig.8 Forward Current vs.

Ambient Temperature(°C)



OPTO INTERRUPTER ITR

Typical Electrical/Optical/Characteristics Curves for PT

ITR8307

Fig.1 Collector Power Dissipation vs. Ambient Temperature

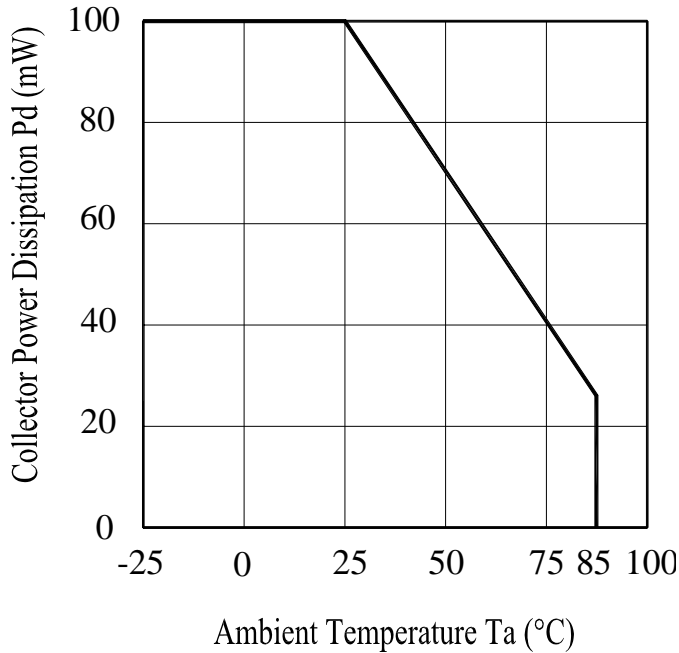

Fig.2 Collector Dark Current vs Ambient Temperature

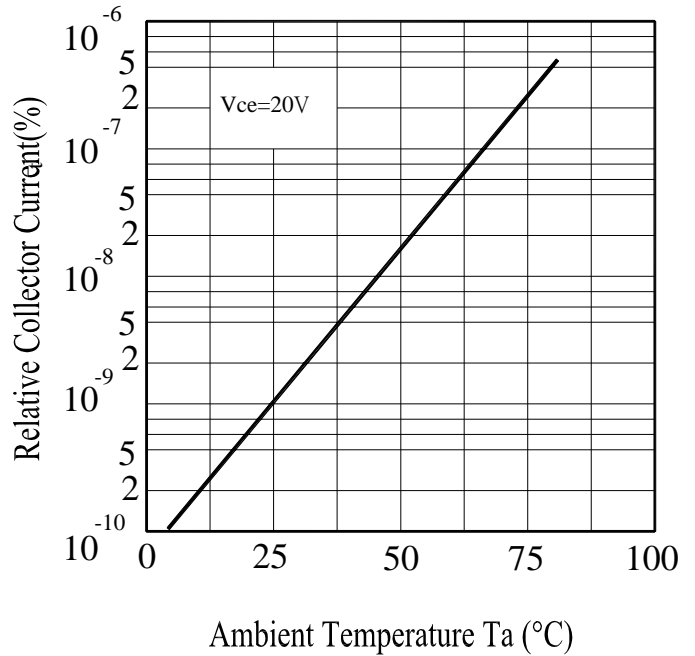

Fig.3 Relative Collector Current vs Ambient Temperature

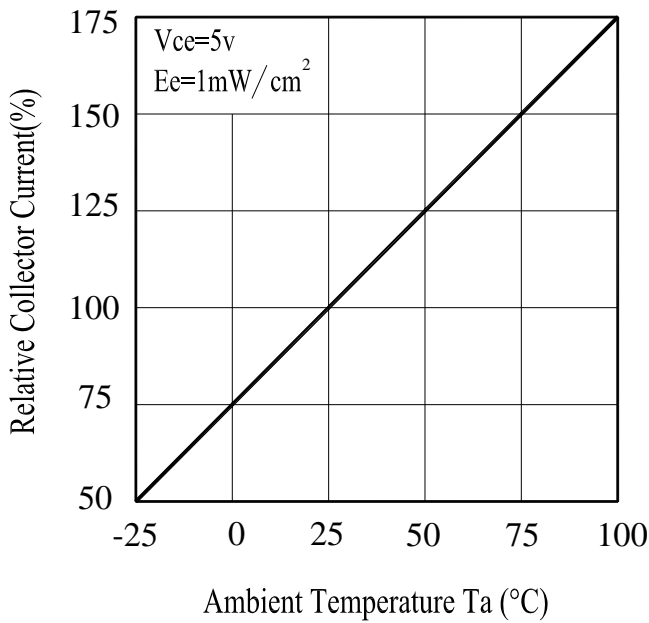
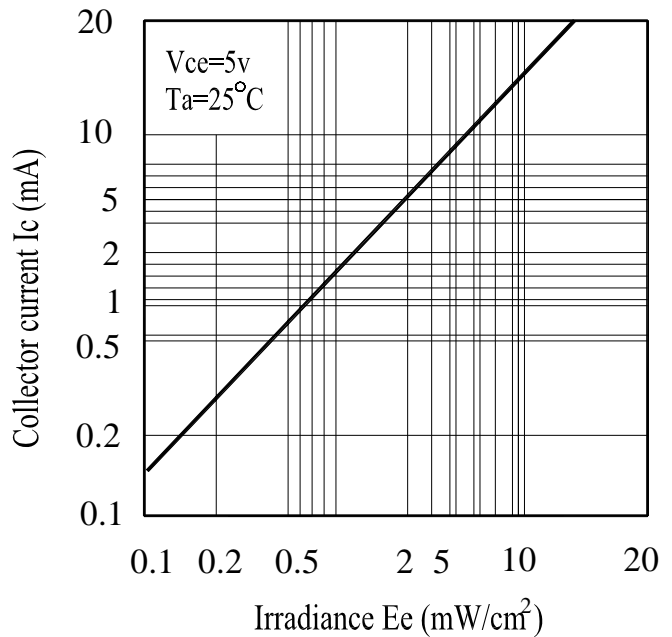

Fig.4 Collector Current vs.Irradiance



OPTO INTERRUPTER ITR

Fig.5 Spectral Sensitivity

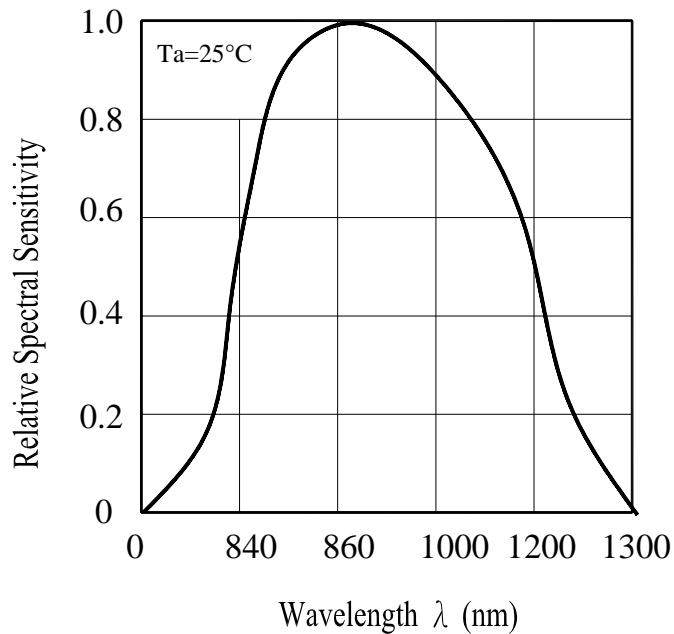
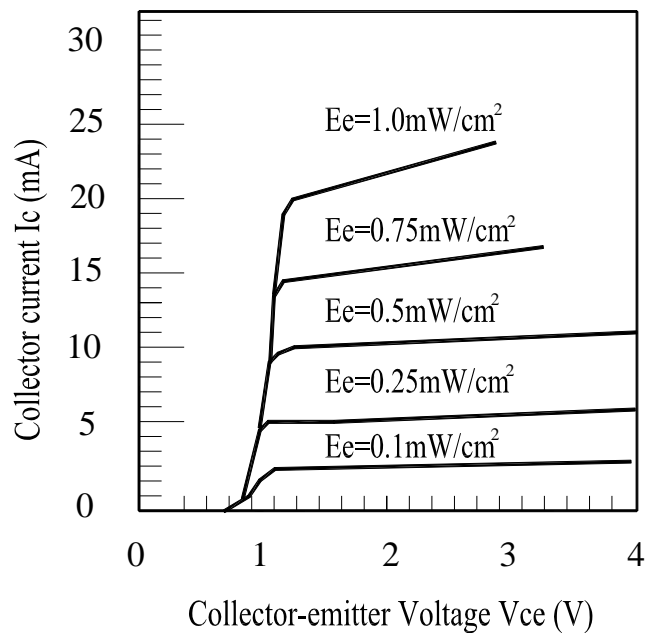

Fig.6 Collector Current vs **ITR8307**
Collector Current I_c (mA)



OPTO INTERRUPTER ITR

Typical Electrical/Optical/Characteristics Curves for ITR

ITR8307

Fig.1 Relative Collector Current vs. Distance .
Between Sensor and Al Evaporation

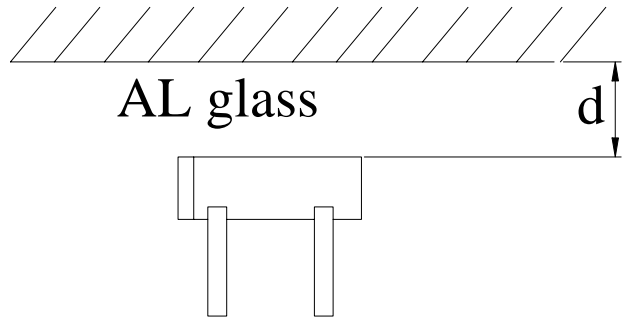
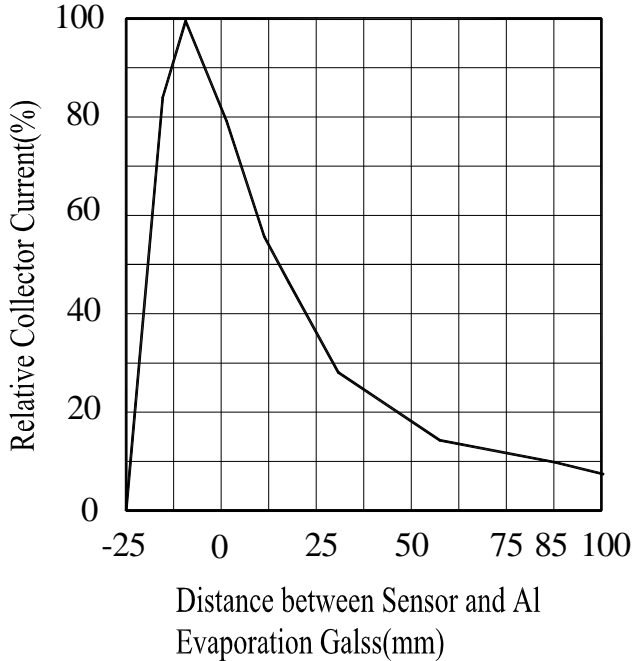
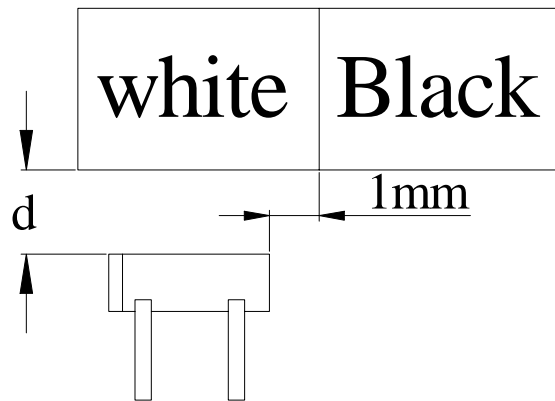
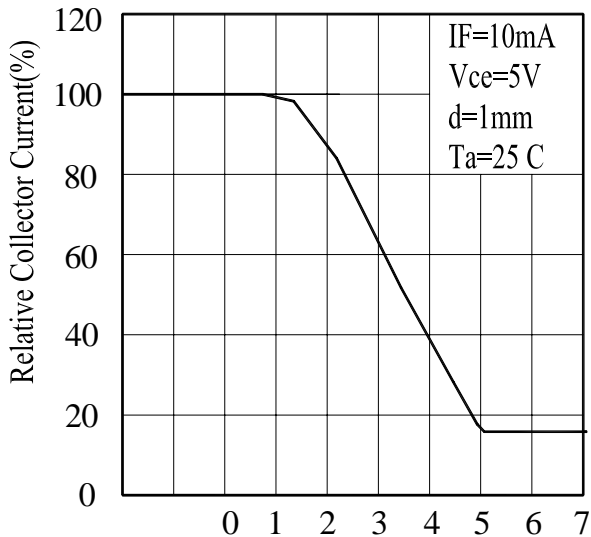

Fig.2 Relative Collector Current vs.
Card moving Distance d(mm)



OPTO INTERRUPTER ITR

Fig.3 Response Time vs. Load Resistance

ITR8307

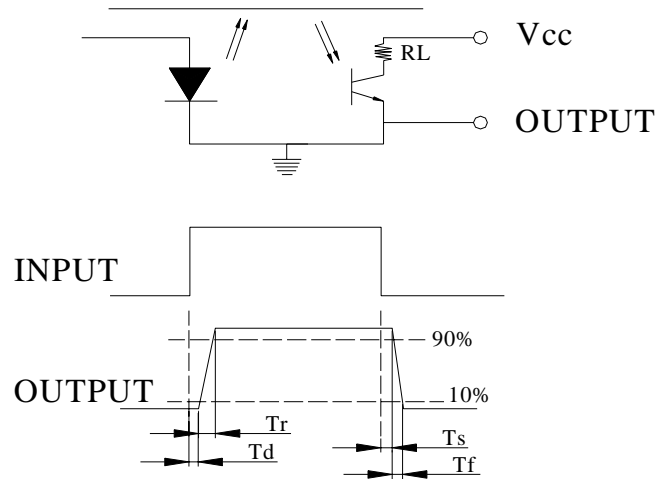
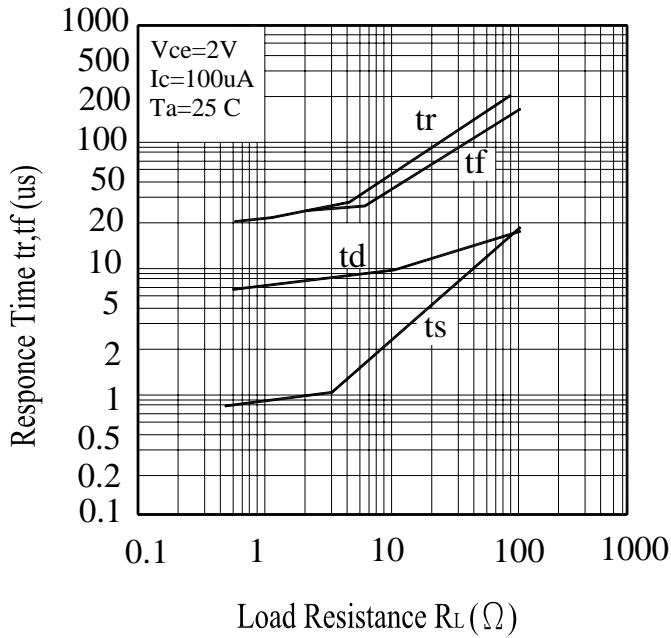

OPTO INTERRUPTER ITR

Reliability Test Item And Condition

ITR8307

The reliability of products shall be satisfied with items listed below.

Confidence level : 90%

LTPD : 10%

NO.	Item	Test Conditions	Test Hours/ Cycles	Sample Sizes	Failure Judgement Criteria	Ac/Re
1	Solder Heat	TEMP. : 260°C±5°C	10secs	22pcs		0/1
2	Temperature Cycle	H : +85°C 30mins ↑ 5mins ↓ L : -55°C 30mins	50Cycles	22pcs	$I_R \geq U \times 2$ $E_e \leq L \times 0.8$ $V_F \geq U \times 1.2$	0/1
3	Thermal Shock	H : +100°C 5mins ↑ 10secs ↓ L : -10°C 5mins	50Cycles	22pcs	U : Upper Specification	0/1
4	High Temperature Storage	TEMP. : +100°C	1000hrs	22pcs	Limit L : Lower	0/1
5	Low Temperature Storage	TEMP. : -55°C	1000hrs	22pcs	Specification Limit	0/1
6	DC Operating Life	$I_F = 20mA$	1000hrs	22pcs		0/1
7	High Temperature/ High Humidity	85°C / 85% R.H	1000hrs	22pcs		0/1

Packing Quantity

1. 1000Pcs/1Bag
2. 1Bag/1Carton

OPTO INTERRUPTER ITR**Recommended Method of Storage****ITR8307**

The following are general recommendations for moisture sensitive level (MSL) 4 storage and use:

- Shelf life in sealed bag: 12 months at < 40 °C and < 90% relative humidity (RH)
- After bag is opened, devices that will be subjected to reflow solder or other high temperature process must
 - a) Mounted within 72 hours of factory conditions < 30 °C/60%RH, or
 - b) Stored at <20% RH
 - Devices require bake, before mounting, if:
Humidity Indicator Card is > 20% when read at 23 ± 5 °C
- If baking is required, devices may be baked:
 - a) 192 hours at 40°C, and <5% RH(dry air/nitrogen) or
 - b) 96 hours at 60°C, and <5% RH for all device containers
 - c) 24 hours at 125 °C

EVERLIGHT ELECTRONICS CO., LTD.

Office: No 25, Lane 76, Sec 3, Chung Yang Rd,
Tucheng, Taipei 236, Taiwan, R.O.C

Tel: 886-2-2267-2000, 2267-9936

Fax: 886-2267-6244, 2267-6189, 2267-6306

<http://www.everlight.com>