

Part No./型号: **599PWC**



ATTENTION
OBSERVE PRECAUTIONS
FOR HANDLING
ELECTROSTATIC
DISCHARGE
SENSITIVE
DEVICES

Features/特性:

- Single color/单色光
- High bright output/高亮度输出
- Low power consumption/低功耗
- High reliability and long life
/可靠性高、寿命长

Descriptions/描述:

- Dice material/芯片材质: GaInN
- Emitting Color/发光颜色:
Super Bright White/高亮度白光
- Device Outline/产品外形:
φ 5mm Round Flat Type
/5mm 平头圆形
- Lens Type/胶体颜色:
Water Clear/无色透明

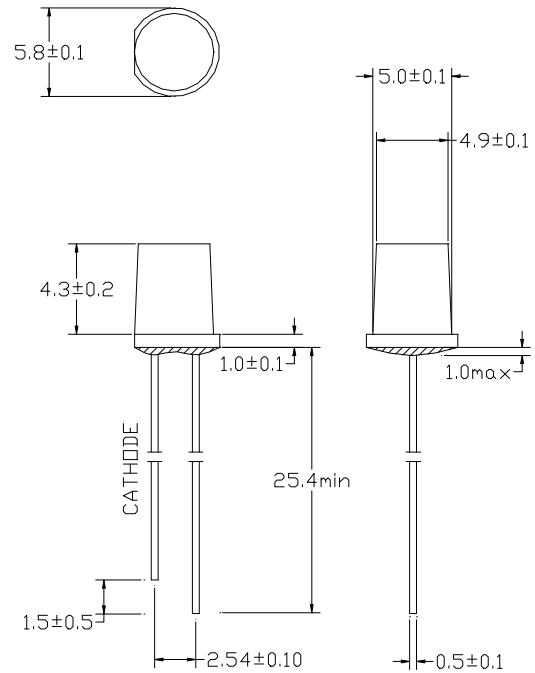

NOTE/注意:

- All dimensions are millimeters/所有尺寸单位: mm.
- Tolerance is $\pm 0.25 \text{ mm}$ unless otherwise noted/未标注的公差均为 $\pm 0.25 \text{ mm}$

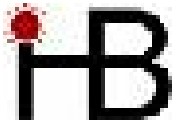

Part No./型号: 599PWC

Absolute maximum ratings/极限参数 (Ta = 25°C)

Parameter 参数	Symbol 符号	Test Condition 测试条件	Value 数值		Unit 单位
			Min.	Max.	
Reverse Voltage 反向电压	V _R	I _R = 30 μA	5	--	V
Forward Current 正向工作电流	I _F	----	----	25	mA
Power Dissipation 损耗功率	P _d	----	----	108	mW
Pulse Current 正向峰值电流	I _{peak}	Duty=0.1mS, 1kHz	----	100	mA
Operating Temperature 工作温度范围	T _{opr}	----	-20	+85	°C
Storage Temperature 储存温度范围	T _{str}	----	-25	+100	°C

Electrical and optical characteristics/光电参数 (Ta = 25°C)

Parameter 参数	Symbol 符号	Test Condition 测试条件	Value 数值			Unit 单位
			Min.	Typ.	Max.	
Forward Voltage 正向电压	V _F	I _F = 20mA	----	3.2	3.6	V
Reverse Current 反向电流	I _R	V _R = 5V	----	----	30	μA
Luminous Intensity 发光强度	I _v	I _F = 20mA	----	700	----	mcd
Viewing Angle 指向角度	2θ 1/2	I _F = 20mA	----	----	----	Deg.

Luminous Intensity Bins Chart/亮度等级 (Ta = 25°C)

Bin	N	P	Q	R	S	T
Min	200	300	400	600	800	1000
Max	300	400	600	800	1000	1500



Part No./型号: **599PWC**

Chromaticity Coordinates Ranks /色坐标等级 (IF=20mA Ta=25°C)

Wa1	X	0.243	0.215	0.230	0.263	Wa2	X	0.263	0.246	0.264	0.280
	Y	0.200	0.230	0.250	0.220		Y	0.220	0.236	0.267	0.248
Wa3	X	0.246	0.230	0.248	0.264	Wb1	X	0.280	0.264	0.283	0.296
	Y	0.236	0.250	0.286	0.267		Y	0.248	0.267	0.305	0.276
Wb2	X	0.264	0.248	0.275	0.283	Wc1	X	0.296	0.287	0.330	0.330
	Y	0.267	0.286	0.321	0.305		Y	0.276	0.295	0.339	0.318
Wc2	X	0.287	0.283	0.330	0.330	Wc3	X	0.283	0.275	0.298	0.306
	Y	0.295	0.305	0.360	0.339		Y	0.305	0.321	0.350	0.332
Wc4	X	0.306	0.298	0.321	0.330	Wd1	X	0.330	0.330	0.361	0.356
	Y	0.332	0.350	0.379	0.360		Y	0.318	0.360	0.385	0.351
Wd2	X	0.330	0.321	0.366	0.361	Wf	X	0.356	0.366	0.391	0.380
	Y	0.360	0.379	0.419	0.385		Y	0.351	0.419	0.436	0.381

CIE 1931 Chromaticity diagram/CIE1931 图

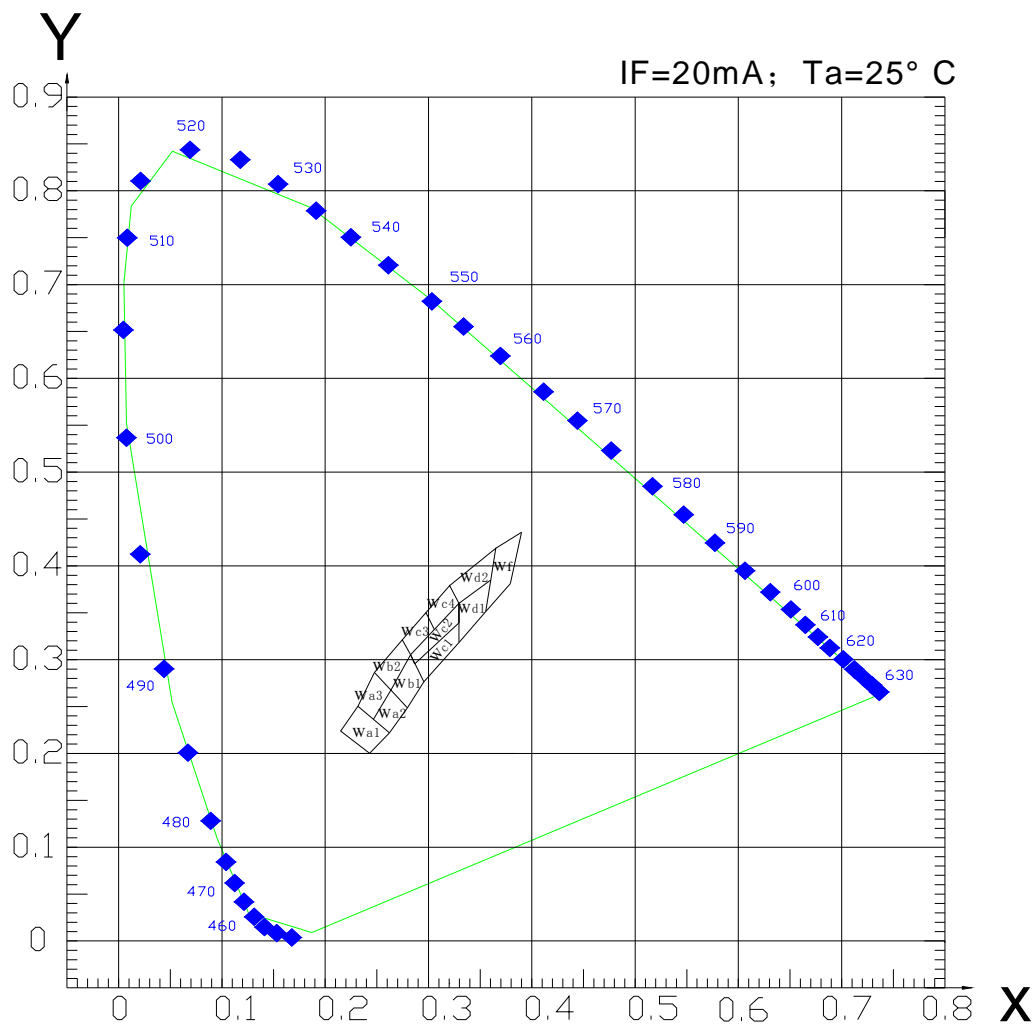



Part No./型号: 599PWC

Typical electrical/optical characteristic curves/光电特性曲线:

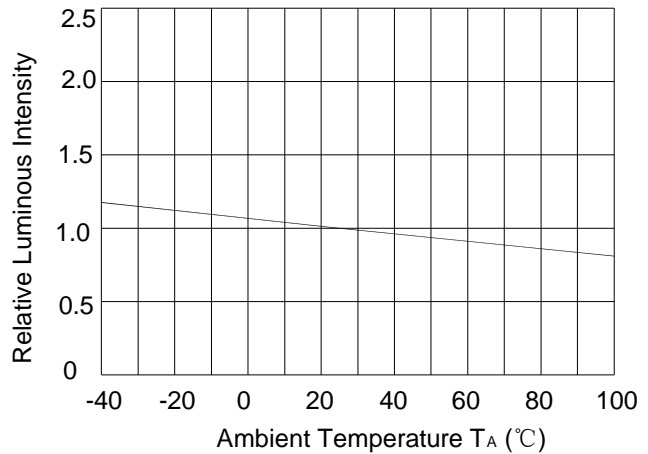
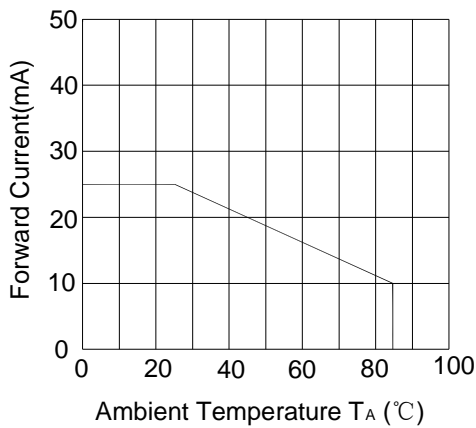
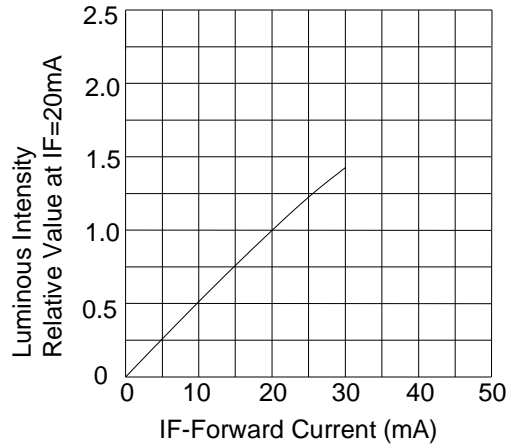
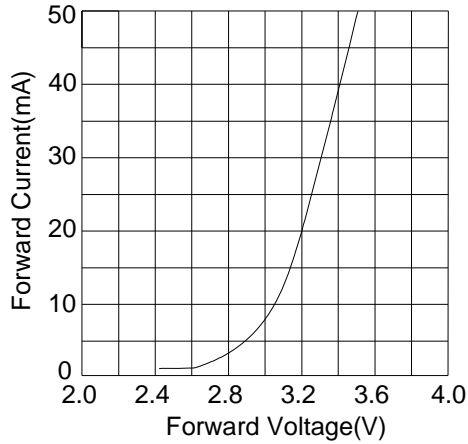
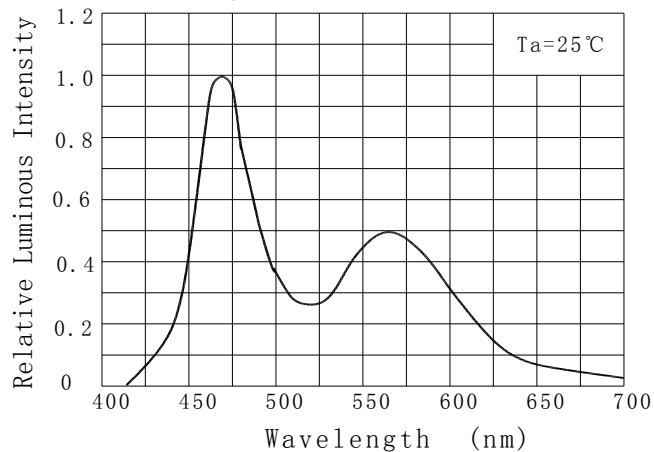
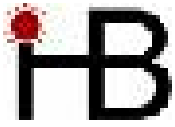

Fig.5 相对亮度 Vs 波长





Part No./型号: 599PWC

Life Test curves /寿命测试曲线

