

# DATA SHEET

**TX10/6/4**  
Ferrite toroids

Supersedes data of September 2004

2008 Sep 01

**RING CORES (TOROIDS)**

**Effective core parameters**

SYMBOL	PARAMETER	VALUE	UNIT
$\Sigma(l/A)$	core factor (C1)	3.07	mm <sup>-1</sup>
$V_e$	effective volume	188	mm <sup>3</sup>
$l_e$	effective length	24.1	mm
$A_e$	effective area	7.8	mm <sup>2</sup>
m	mass of core	≈ 0.95	g

**Coating**

The cores are coated with epoxy, flame retardant in accordance with "UL 94V-0"; UL file number E 228348. The colour is white.

Maximum operating temperature is 200 °C.

**Isolation voltage**

DC isolation voltage: 1000 V.

Contacts are applied on the edge of the ring core, which is also the critical point for the winding operation.

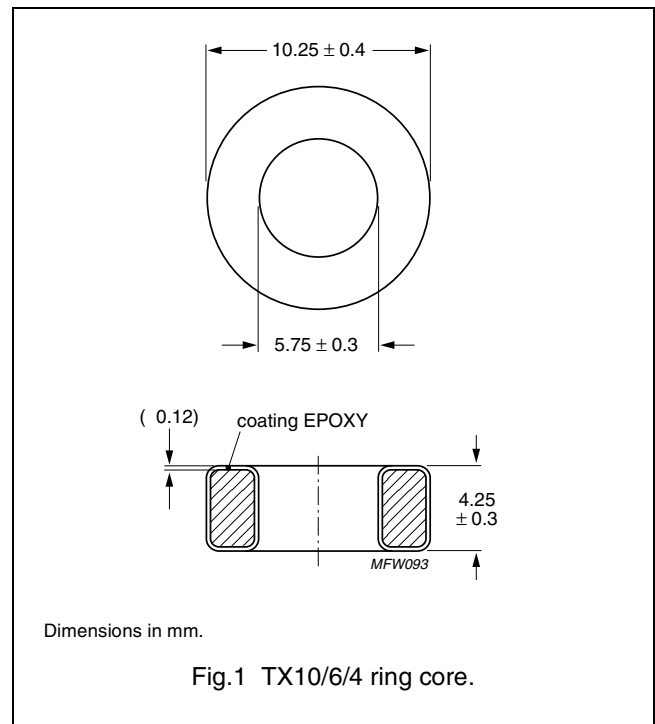

**Ring core data**

GRADE	$A_L$ (nH)	$\mu_i$	TYPE NUMBER
3E5	3470 ± 30%	≈ 8500	TX10/6/4-3E5
3E6 <span style="background-color: black; color: white; padding: 0 2px;">des</span>	4085 ± 30%	≈ 10000	TX10/6/4-3E6

**DATA SHEET STATUS DEFINITIONS**

DATA SHEET STATUS	PRODUCT STATUS	DEFINITIONS
Preliminary specification	Development	This data sheet contains preliminary data. Ferroxcube reserves the right to make changes at any time without notice in order to improve design and supply the best possible product.
Product specification	Production	This data sheet contains final specifications. Ferroxcube reserves the right to make changes at any time without notice in order to improve design and supply the best possible product.

**DISCLAIMER**

**Life support applications** — These products are not designed for use in life support appliances, devices, or systems where malfunction of these products can reasonably be expected to result in personal injury. Ferroxcube customers using or selling these products for use in such applications do so at their own risk and agree to fully indemnify Ferroxcube for any damages resulting from such application.

**PRODUCT STATUS DEFINITIONS**

STATUS	INDICATION	DEFINITION
<b>Prototype</b>		These are products that have been made as development samples for the purposes of technical evaluation only. The data for these types is provisional and is subject to change.
<b>Design-in</b>		These products are recommended for new designs.
<b>Preferred</b>		These products are recommended for use in current designs and are available via our sales channels.
<b>Support</b>		These products are <b>not</b> recommended for new designs and may not be available through all of our sales channels. Customers are advised to check for availability.