

# SD0103WS

## SILICON SCHOTTKY BARRIER DIODE

### Features

- Low forward voltage drop and suitable for high efficiency rectifying
- Ultra small resin package is suitable for high density surface mounting and high speed assembly

### PINNING

PIN	DESCRIPTION
1	Cathode
2	Anode

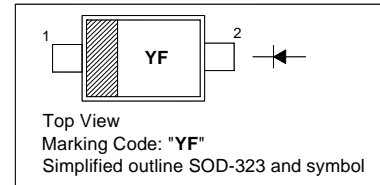

### Absolute Maximum Ratings ( $T_a = 25\text{ }^\circ\text{C}$ )

Parameter	Symbol	Value	Unit
Repetitive Peak Reverse Voltage	$V_{RRM}$	30	V
Mean Rectifying Current	$I_O$	100	mA
Non-Repetitive Peak Forward Surge Current (8.3 ms Single Half Sine Wave)	$I_{FSM}$	1	A
Junction Temperature	$T_j$	125	$^\circ\text{C}$
Storage Temperature Range	$T_s$	- 55 to + 125	$^\circ\text{C}$

### Characteristics at $T_a = 25\text{ }^\circ\text{C}$

Parameter	Symbol	Max.	Unit
Forward Voltage at $I_F = 100\text{ mA}$	$V_F$	0.44	V
Reverse Current at $V_R = 30\text{ V}$	$I_R$	50	$\mu\text{A}$

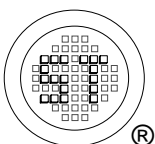

**SEMTECH ELECTRONICS LTD.**

(Subsidiary of Sino-Tech International Holdings Limited, a company  
listed on the Hong Kong Stock Exchange, Stock Code: 724)



Dated : 01/11/2007

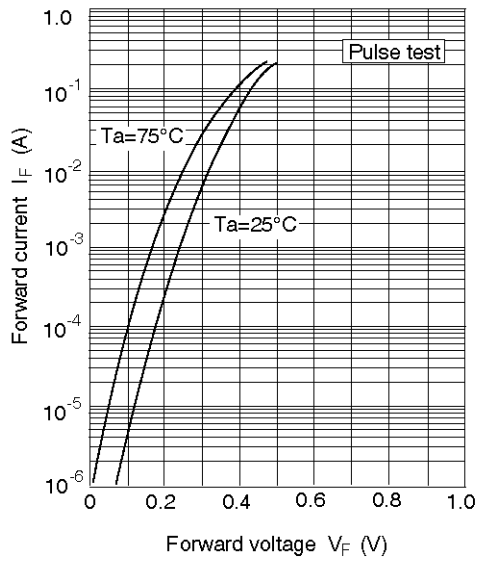

Fig.1 Forward current Vs. Forward voltage

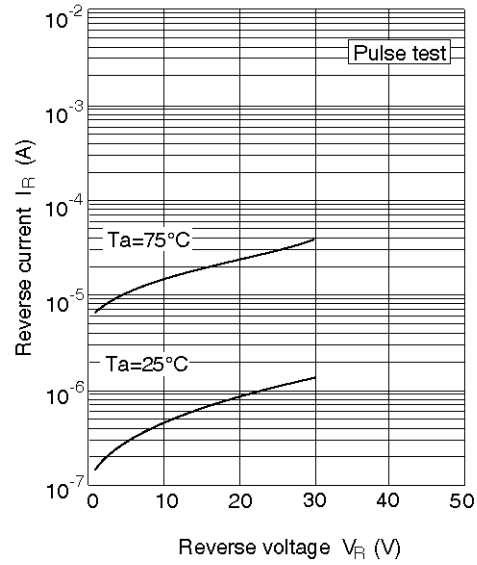

Fig.2 Reverse current Vs. Reverse voltage

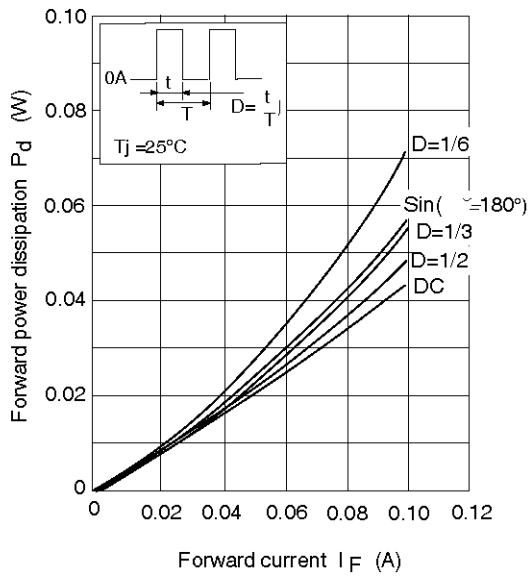

Fig.3 Forward power dissipation Vs. Forward current

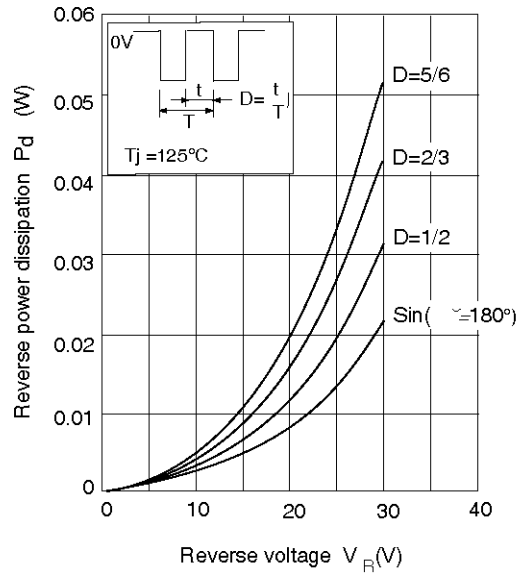
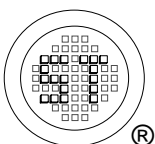

Fig.4 Reverse power dissipation Vs. Reverse voltage



**SEMTECH ELECTRONICS LTD.**  
 (Subsidiary of Sino-Tech International Holdings Limited, a company listed on the Hong Kong Stock Exchange, Stock Code: 724)



## PACKAGE OUTLINE

Plastic surface mounted package; 2 leads

SOD-323

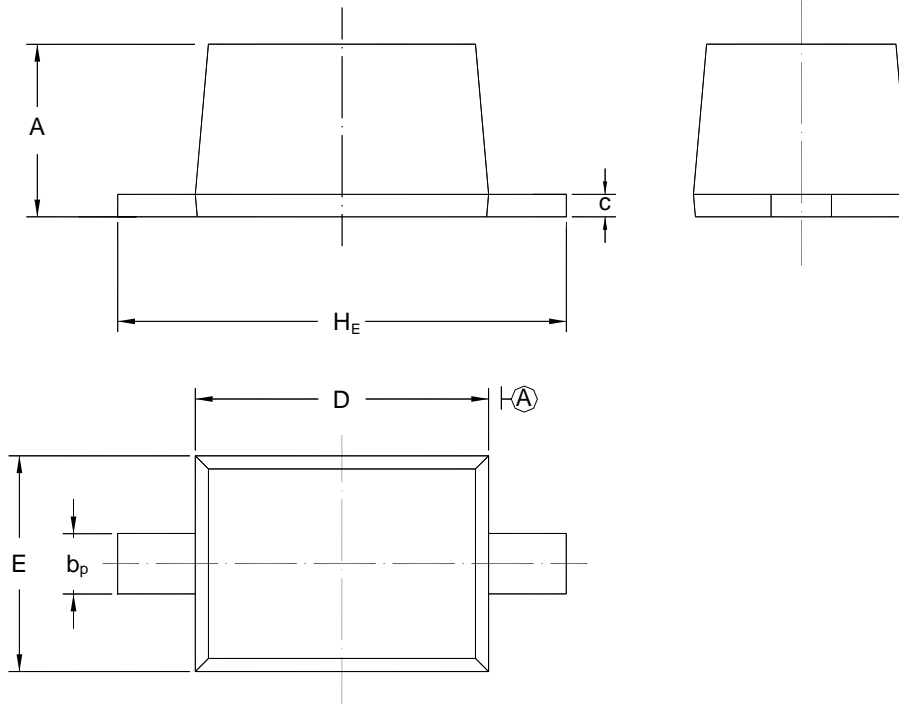

UNIT	A	b <sub>p</sub>	C	D	E	H <sub>E</sub>
mm	1.10 0.80	0.40 0.25	0.15 0.00	1.80 1.60	1.35 1.15	2.80 2.30

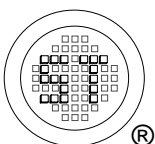

**SEMTECH ELECTRONICS LTD.**  
 (Subsidiary of Sino-Tech International Holdings Limited, a company  
 listed on the Hong Kong Stock Exchange, Stock Code: 724)



Dated : 01/11/2007