

Typical Units

High power density building blocks ideal for on-board power-distribution schemes in which isolated 12V buses deliver power to any number of non-isolated, step-down buck regulators.

FEATURES

- Step-down buck regulators for new distributed 12V power architectures
- 12V input (10-14V range)
- 0.75-5VOUT @ 10 Amps
- Non-isolated, fixed-frequency, synchronous-rectifier topology
- Outstanding performance:
 - Efficiencies to 96.5% @ 10 Amps
 - Low noise
 - Stable no-load operation
 - Adjustable output voltage
- Remote on/off control
- Sense pin on standard models
- Thermal shutdown
- No derating to +85°C with 100 lfm
- UL/IEC/EN60950 applied for
- EMC compliant
- Start up into pre-biased Load

PRODUCT OVERVIEW

LSN D12 DC/DC's accept a 12V input (10-14V input range) and convert it, with the highest efficiency in the smallest space, to a 0.75 to 5 Volt output fully rated at 10 Amps. The output is user-adjustable by trim resistor or adjustment voltage.

LSN D12's are ideal point-of-use/load power processors. They typically require no external components. Their vertical-mount packages occupy a mere 0.7 square inches (4.5 sq. cm), and reversed pin vertical mount allows mounting to meet competitor's keep out area. Horizontal-mount packages ("H" suffix) are only 0.35 inches (8.89mm) high.

The LSN's best-in-class power density is achieved with a fully synchronous, fixed-frequency, buck topology that also delivers: high efficiency (96.5%

for 5V_{OUT} models), low noise (35mVp-p typ.), tight line/load regulation, quick step response (50µsec), stable no-load operation, and no output reverse conduction.

The fully functional LSN's feature output overcurrent detection, continuous short-circuit protection, an output-voltage trim function, a remote on/off control pin, thermal shutdown and a sense pin. High efficiency enables, the LSN D12's to deliver rated output currents of 10 Amps at ambient temperatures to +85°C with natural convection.

If your new system boards call for three or more supply voltages, check out the economics of on-board 12V distributed power. If you don't need to pay for multiple isolation barriers, Datel non-isolated LSN D12 SIP's will save you money.

SIMPLIFIED SCHEMATIC

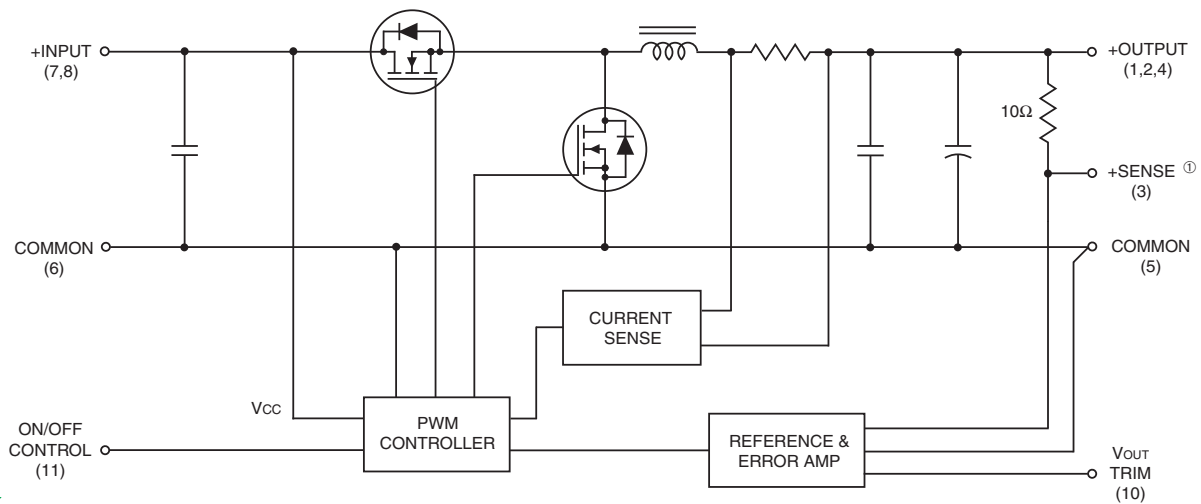

① For devices with the sense-pin removed ("B" suffix), the feedback path is through the +Output pin and not the +Sense pin.

Typical topology is shown



For full details go to www.murata-ps.com/rohs

PERFORMANCE SPECIFICATIONS AND ORDERING GUIDE ^①													
Model ^⑤	Output						Input			Efficiency			Package (Case/ Pinout)
	V _{OUT} (Volts)	I _{OUT} (Amps)	R/N (mVp-p) ^②		Regulation (Max.) ^③		V _{IN} Nom. (Volts)	Range (Volts)	I _{IN} ^④ (mA/A)	Full Load		V _{IN} =10V	
			Typ.	Max.	Line	Load				Min.	Typ.	Typ.	
LSN-T/10-D12	0.7525-5.5	10	35	55	±0.06%	±0.2%	12	10-14	80/4.32	95.5%	96.5%	97%	B5/B5x, P59

^① Typical at T_A = +25°C under nominal line voltage, V_{OUT} = 5V, and full-load conditions, unless otherwise noted. All models are tested and specified with external 22µF tantalum input and output capacitors. These capacitors are necessary to accommodate our test equipment and may not be required to achieve specified performance in your applications. See I/O Filtering and Noise Reduction.

^② Ripple/Noise (R/N) is tested/specified over a 20MHz bandwidth and may be reduced with external filtering. See I/O Filtering and Noise Reduction for details.

^③ These devices have no minimum-load requirements and will regulate under no-load conditions. Regulation specifications describe the output-voltage deviation as the line voltage or load is varied from its nominal/midpoint value to either extreme.

^④ Nominal line voltage, no-load/full-load conditions.

^⑤ This is not a complete model number. Please see the Part Number Structure when ordering.

PART NUMBER STRUCTURE

L SN - T / 10 - D12 N H J - C

Output Configuration:
L = Unipolar

Nominal Output Voltage:
T = 0.75 - 5.25

Maximum Rated Output Current in Amps

RoHS-6 Compliant

J Suffix:
Reversed Pin Vertical Mount

H Suffix:
Horizontal Mount

N Suffix:
On/Off Polarity:
Blank = Positive logic
N = Negative logic

Input Voltage Range:
D12 = 10-14 Volts (12V nominal)

Note:
Not all model number combinations are available. Contact Murata Power Solutions.

MECHANICAL SPECIFICATIONS - HORIZONTAL MOUNTING

Case B5A - Horizontal Mounting

RECOMMENDED COPPER PAD ON PCB (0.55 SQ. IN.)

LAYOUT PATTERN TOP VIEW

All dimension in Inches (mm)

MECHANICAL SPECIFICATIONS - VERTICAL MOUNTING

Case B5 - Vertical Mounting (Standard)

LAYOUT PATTERN TOP VIEW

Case B5B - Reverse Pin Vertical Mounting (Tyco-compatible package)

LAYOUT PATTERN TOP VIEW

All dimension in Inches (mm)

I/O Connections

Pin	Function P59	Pin	Function P59	Pin	Function P59
1	+Output	5	Common	9	No Pin
2	+Output	6	Common	10	V _{OUT} Trim
3	+Sense	7	+Input	11	On/Off Control
4	+Output	8	+Input		

Performance/Functional Specifications

Typical @ $T_A = +25^\circ\text{C}$ under nominal line voltage, $V_{\text{OUT}}=5\text{V}$, and full-load conditions unless noted. ^①

Input	
Input Voltage Range	10-14 Volts (12V nominal)
Input Current:	
Normal Operating Conditions	See Ordering Guide
Inrush Transient	0.02A ² sec
Standby/Off Mode	5mA
Output Short-Circuit Condition ^②	60mA average
Input Reflected Ripple Current ^②	30mA _{p-p}
Input Filter Type	Capacitive
Overvoltage Protection	None
Reverse-Polarity Protection	None
Start-up Voltage	9.2 Volts
Undervoltage Shutdown	8 Volts
On/Off Control ^{②③}	On = Pin open to + V_{IN} max. Off = Zero (ground) to +0.8V max. Negative Polarity On = Pin open or grounded to +0.3V Off = +2.5V to + V_{IN} max.
On/Off Current	0.5 mA maximum
Output	
Maximum Output Power ^⑤	51 Watts
V_{OUT} Accuracy (50% load)	±2%
Minimum Loading ^①	No minimum load
Maximum Capacitive Load	2,000 μF (ESR < 0.02 Ohms) 10,000 μF (ESR > 0.02 Ohms)
V_{OUT} Trim Range ^{②⑤}	+0.7525 to +5.5 Volts (no load)
Ripple/Noise (20MHz BW) ^{①②④}	See Ordering Guide
Extreme Accuracy	3% max. over line/load/temperature
Efficiency ^②	See Ordering Guide
Pre-Bias Startup	Converter will start up if the external output voltage is less than V_{setpoint}
Overcurrent Detection and Short-Circuit Protection: ^②	
Current-Limit Inception	
Cold Condition	21 Amps
Short-Circuit Detection Point	98% of V_{OUT} set
SC Protection Technique	Hiccup with auto recovery
Short-Circuit Current	400mA average
Dynamic Characteristics	
Transient Response (50-100-50% load)	50 μsec to ±2% of final value
Start-Up Time: ^②	
V_{IN} to V_{OUT} and On/Off to V_{OUT}	8msec
Switching Frequency:	250 ±30 KHz
Environmental	
Calculated MTBF ^⑤	TBC
Operating Temperature: (Ambient) ^②	
Without Derating (Natural convection)	-40 to +85°C
With Derating	See Derating Curves
Storage Temperature	-40 to +125°C
Thermal Shutdown	+115°C
Physical	
Dimensions	See Mechanical Specifications
Pin Dimensions/Material	0.03" (0.76mm) dia. round copper with tin plate over nickel underplate. Length: 0.17" (4.32mm)
Weight	0.3 ounces (8.5g)
Flamability Rating	UL94V-0

Absolute Maximum Ratings

Input Voltage:	
Continuous or transient	14 Volts
On/Off Control (Pin 11)	+ V_{IN}
Input Reverse-Polarity Protection	None
Output Overvoltage Protection	None
Output Current	Current limited. Devices can withstand sustained output short circuits without damage.
Storage Temperature	-40 to +125°C
Lead Temperature (soldering, 10 sec.)	+280°C

These are stress ratings. Exposure of devices to any of these conditions may adversely affect long-term reliability. Proper operation under conditions other than those listed in the Performance/Functional Specifications Table is not implied.

- ^① All models are tested and specified with external 22 μF tantalum input and 10 || 1 μF output capacitors. These capacitors are necessary to accommodate our test equipment and may not be required to achieve specified performance in your applications. All models are stable and regulate within spec under no-load conditions.
- ^② See Technical Notes and Performance Curves for details.
- ^③ The On/Off Control (pin 11) is designed to be driven with open-collector logic or the application of appropriate voltages (referenced to Common, pins 5 and 6).
- ^④ Output noise may be further reduced with the installation of additional external output filtering. See I/O Filtering and Noise Reduction.
- ^⑤ MTBF's are calculated using Telcordia SR-332(Bellcore), ground fixed, $T_A = +25^\circ\text{C}$, full power, natural convection.
- ^⑥ Do not exceed maximum rated output power when adjusting the output voltage.

TECHNICAL NOTES

Return Current Paths

The LSN D12 SIP's are non-isolated DC/DC converters. Their two Common pins (pins 5 and 6) are connected to each other internally (see Figure 1). To the extent possible (with the intent of minimizing ground loops), input return current should be directed through pin 6 (also referred to as –Input or Input Return), and output return current should be directed through pin 5 (also referred to as –Output or Output Return). Any on/off control signals applied to pin 11 (On/Off Control) should be referenced to Common (specifically pin 6).

I/O Filtering and Noise Reduction

All models in the LSN D12 Series are tested and specified with external 22 μ F tantalum input and 10 || 1 μ F output capacitors. These capacitors are necessary to accommodate our test equipment and may not be required to achieve desired performance in your application. The LSN D12's are designed with high-quality, high-performance internal I/O caps, and will operate within spec in most applications with no additional external components.

In particular, the LSN D12's input capacitors are specified for low ESR and are fully rated to handle the units' input ripple currents. Similarly, the internal output capacitors are specified for low ESR and full-range frequency response.

In critical applications, input/output ripple/noise may be further reduced using filtering techniques, the simplest being the installation of external I/O caps.

External input capacitors serve primarily as energy-storage devices. They minimize high-frequency variations in input voltage (usually caused by IR drops in conductors leading to the DC/DC) as the switching converter draws pulses of current. Input capacitors should be selected for bulk capacitance (at appropriate frequencies), low ESR, and high rms-ripple-current ratings. The switching nature of modern DC/DC's requires that the dc input voltage source have low ac impedance at the frequencies of interest. Highly inductive source impedances can greatly affect system stability. Your specific system configuration may necessitate additional considerations.

Output ripple/noise (also referred to as periodic and random deviations or PARD) may be reduced below specified limits with the installation of additional external output capacitors. Output capacitors function as true filter elements and should be selected for bulk capacitance, low ESR, and appropriate frequency response. Any scope measurements of PARD should be made directly at the DC/DC output pins with scope probe ground less than 0.5" in length.

All external capacitors should have appropriate voltage ratings and be located as close to the converters as possible. Temperature variations for all relevant parameters should be taken into consideration.

The most effective combination of external I/O capacitors will be a function of your line voltage and source impedance, as well as your particular load and layout conditions. Our Applications Engineers can recommend potential solutions and discuss the possibility of our modifying a given device's internal filtering to meet your specific requirements. Contact our Applications Engineering Group for additional details.

Input Fusing

Most applications and or safety agencies require the installation of fuses at the inputs of power conversion components. LSN D12 Series DC/DC converters are not internally fused. Therefore, if input fusing is mandatory, either a normal-blow or a slow-blow fuse with a value no greater than 15 Amps

should be installed within the ungrounded input path to the converter.

As a rule of thumb however, we recommend to use a normal-blow or slow-blow fuse with a typical value of about twice the maximum input current, calculated at low line with the converters minimum efficiency.

Safety Considerations

LSN D12 SIP's are non-isolated DC/DC converters. In general, all DC/DC's must be installed, including considerations for I/O voltages and spacing/separation requirements, in compliance with relevant safety-agency specifications (usually UL/IEC/EN60950).

In particular, for a non-isolated converter's output voltage to meet SELV (safety extra low voltage) requirements, its input must be SELV compliant.

If the output needs to be ELV (extra low voltage), the input must be ELV.

Input Overvoltage and Reverse-Polarity Protection

LSN D12 SIP Series DC/DC's do not incorporate either input overvoltage or input reverse-polarity protection. Input voltages in excess of the specified absolute maximum ratings and input polarity reversals of longer than "instantaneous" duration can cause permanent damage to these devices.

Start-Up Time

The V_{IN} to V_{OUT} Start-Up Time is the interval between the time at which a ramping input voltage crosses the lower limit of the specified input voltage range and the fully loaded output voltage enters and remains within its specified accuracy band. Actual measured times will vary with input source impedance, external input capacitance, and the slew rate and final value of the input voltage as it appears to the converter.

The On/Off to V_{OUT} Start-Up Time assumes the converter is turned off via the On/Off Control with the nominal input voltage already applied to the converter. The specification defines the interval between the time at which the converter is turned on and the fully loaded output voltage enters and remains within its specified accuracy band. See Typical Performance Curves.

Installing the Converter

These converters may be installed into either commercial pin sockets on 0.1" centers (similar to those used with through-hole integrated circuits) or inserted into plated-through holes on the host printed circuit board. Pin sockets obviously facilitate repair and replacement whereas PCB mounting is mechanically and electrically more secure. Soldered-down PCB installation also conducts more heat away from the converter. Consider increasing the copper etch area near the output pins.

Do not use excessive force when installing these converters. If you are not inserting the converter into pin sockets, make sure the holes on the host printed circuit board are of adequate size and spaced properly. You may bend the pins slightly to line them up with the PCB holes. Using two needle nose pliers, securely hold the base of the pin with one plier (where it enters the converter's PCB or the lead frame) and apply a very small bend with the other plier part way down the pin length. The two-plier method avoids excessive force on the converter's PCB. If pins are bent too far or too great an insertion force is used during installation, this may cause hidden damage on the converter, possibly voiding the warranty.

Remote Sense

LSN D12 SIP Series DC/DC converters offer an output sense function on pin 3.

The sense function enables point-of-use regulation for overcoming moderate IR drops in conductors and/or cabling. Since these are non-isolated devices whose inputs and outputs usually share the same ground plane, sense is provided only for the +Output.

The remote sense line is part of the feedback control loop regulating the DC/DC converter's output. The sense line carries very little current and consequently requires a minimal cross-sectional-area conductor. As such, it is not a low-impedance point and must be treated with care in layout and cabling. Sense lines should be run adjacent to signals (preferably ground), and in cable and/or discrete-wiring applications, twisted-pair or similar techniques should be used. To prevent high frequency voltage differences between V_{OUT} and Sense, we recommend installation of a 1000pF capacitor close to the converter.

The sense function is capable of compensating for voltage drops between the +Output and +Sense pins that do not exceed 10% of V_{OUT} .

$$[V_{OUT(+)} - \text{Common}] - [\text{Sense}(+) - \text{Common}] \leq 10\%V_{OUT}$$

Power derating (output current limiting) is based upon maximum output current and voltage at the converter's output pins. Use of trim and sense functions can cause the output voltage to increase, thereby increasing output power beyond the LSN's specified rating. Therefore:

$$(V_{OUT} \text{ at pins}) \times (I_{OUT}) \leq \text{rated output power}$$

The internal 10Ω resistor between +Sense and +Output (see Figure 1) serves to protect the sense function by limiting the output current flowing through the sense line if the main output is disconnected. It also prevents output voltage runaway if the sense connection is disconnected.

Note: Connect the +Sense pin (pin 3) to +Output (pin 4) at the DC/DC converter pins, if the sense function is not used for remote regulation.

On/Off Control

The On/Off Control pin may be used for remote on/off operation. LSN-T/10-D12 SIP is designed so they are enabled when the control pin is left open (internal pull-down to Common) and disabled when the control pin is pulled high, as shown in Figure 2 and 2a.

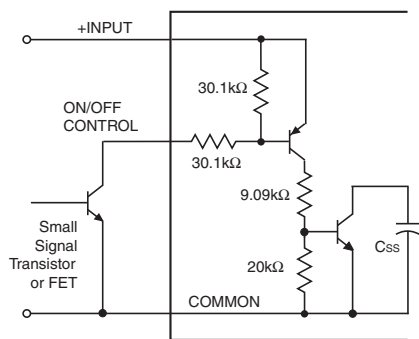

Figure 2. Driving the On/Off Control Pin with an Open-Collector Drive Circuit

Dynamic control of the on/off function is best accomplished with a mechanical relay or open-collector/open-drain drive circuit. The drive circuit should be able to sink appropriate current when activated and withstand appropriate voltage when deactivated. The on/off control function, however, can be externally inverted so that the converter will be disabled while the input voltage is ramping up and then "released" once the input has stabilized.

LSN D12 SIP Series DC/DC converters do not incorporate output overvoltage protection. In the extremely rare situation in which the device's feedback loop is broken, the output voltage may run to excessively high levels ($V_{OUT} = V_{IN}$). If it is absolutely imperative that you protect your load against any and all possible overvoltage situations, voltage limiting circuitry must be provided external to the power converter.

Output Overcurrent Detection

Overloading the output of a power converter for an extended period of time will invariably cause internal component temperatures to exceed their maximum ratings and eventually lead to component failure. High-current-carrying components such as inductors, FET's and diodes are at the highest risk. LSN D12 SIP Series DC/DC converters incorporate an output overcurrent detection and shutdown function that serves to protect both the power converter and its load.

If the output current exceeds its maximum rating by typically 70% or if the output voltage drops to less than 98% of its original value, the LSN D12's internal overcurrent-detection circuitry immediately turns off the converter, which then goes into a "hiccup" mode. While hiccupping, the converter will continuously attempt to restart itself, go into overcurrent, and then shut down. Under these conditions, the average output current will be approximately 400mA. Once the output short is removed, the converter will automatically restart itself.

Thermal Performance

The typical output-current thermal-derating curves shown below enable designers to determine how much current they can reliably derive from each model of the LSN D12 SIP's under known ambient-temperature and air-flow conditions. Similarly, the curves indicate how much air flow is required to reliably deliver a specific output current at known temperatures.

The highest temperatures in LSN D12 SIP's occur at their output inductor, whose heat is generated primarily by I^2R losses. The derating curves were developed using thermocouples to monitor the inductor temperature and varying the load to keep that temperature below +110°C under the assorted conditions of air flow and air temperature. Once the temperature exceeds +115°C (approx.), the thermal protection will disable the converter. Automatic restart occurs after the temperature has dropped below +110°C.

Lastly, when LSN D12 SIP's are installed in system boards, they are obviously subject to numerous factors and tolerances not taken into account here. If you are attempting to extract the most current out of these units under demanding temperature conditions, we advise you to monitor the output-inductor temperature to ensure it remains below +110°C at all times.

Thermal Performance for "H" Models

Enhanced thermal performance can be achieved when LSN D12 SIP's are mounted horizontally ("H" models) and the output inductor (with its electrically isolating, thermally conductive pad installed) is thermally coupled to a copper plane/pad (at least 0.55 square inches in area) on the system board. Your conditions may vary, however our tests indicate this configuration delivers a 16°C to 22°C improvement in ambient operating temperatures.

Pre-Biased Startup

Newer systems with multiple power voltages have an additional problem besides startup sequencing. Some sections have power already partially applied (possibly because of earlier power sequencing) or have leakage power present so that the DC/DC converter must power up into an existing voltage. This power may either be stored in an external bypass capacitor or supplied by an active source.

This “pre-biased” condition can also occur with some types of programmable logic or because of blocking diode leakage or small currents passed through forward biased ESD diodes. Conventional DC/DC’s may fail to start up correctly if there is output voltage already present. And some external circuits are adversely affected when the low side MOSFET in a synchronous rectifier converter sinks current at start up.

The LSN2 series includes a pre-bias startup mode to prevent these initialization problems. Essentially, the converter acts as a simple buck converter until the output reaches its set point voltage at which time it converts to a synchronous rectifier design. This feature is variously called “monotonic” because the voltage does not decay (from low side MOSFET shorting) or produce a negative transient once the input power is applied and the startup sequence begins.

Output Adjustments

The LSN-T/10-D12J includes an output adjustment and trimming function which is fully compatible with competitive units. The output voltage may be varied using a single trim resistor from the Trim input to Power Common or an external DC trim voltage applied between the Trim input and Power Common.

For resistor trim adjustments, be sure to use a precision low-tempco resistor (± 100 ppm/°C) mounted close to the converter with short leads. Since the output accuracy is $\pm 2\%$ (typical), you may need to vary this resistance slightly.

For adjustments using an external voltage reference, the equivalent input impedance looking in to the Trim input is approximately 5,000 Ohms. Therefore you may have to compensate for this in the source resistance of your external reference. Although filtered internally, the Trim input is sensitive and therefore susceptible to noise pickup with longer leads. Consider adding a small bypass capacitor, 0.1 μ F or larger mounted adjacent to the converter between the Trim and Power Common if there is noise in the application.

The Trim input voltage range is offset against the 0.7 Volt reference of the PWM. Also note that the Trim input is inverting (lower trim voltage produces higher output voltage and vice versa). Do not exceed the voltage range or maximum power rating.

D12 Models Resistor Trim Equation:

$$R_{TRIM} (\Omega) = \frac{10500}{V_o - 0.7525} - 1000$$

where V_o is the desired output voltage.

V _{OUT}	0.7525V	1.0V	1.2V	1.5V	1.8V	2V	2.5V	3.3V	5V
R _{TRIM} (k Ω)	Open	41.424	22.46	13.05	9.024	7.417	5.009	3.122	1.472

D12 Models Voltage Trim Equation:

$$V_{TRIM} \text{ (in Volts)} = 0.7 - (0.0667 \times (V_o - 0.7525))$$

where V_o is the desired output voltage.

The D12 fixed trim voltages to set the output voltage are:

V _{OUT}	0.7525V	1.0V	1.2V	1.5V	1.8V	2V	2.5V	3.3V	5V
V _{TRIM} (V)	Open	0.6835	0.670	0.650	0.630	0.617	0.583	0.530	0.4166

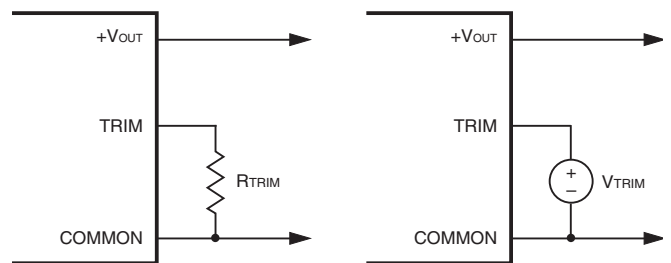

Trim Connections

TYPICAL PERFORMANCE CURVES FOR LSN D12 SIP SERIES

LSN-T/10-D12
Efficiency vs. Line Voltage and Load Current @ 25°C, V_{out} = 0.75V

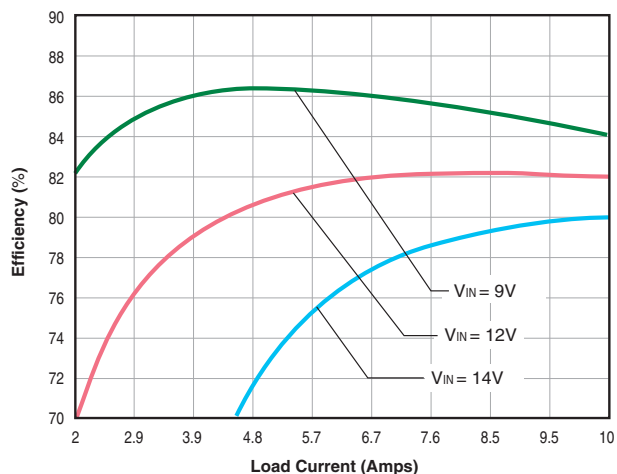

LSN-T/10-D12
Efficiency vs. Line Voltage and Load Current @ 25°C, V_{out} = 1.5V

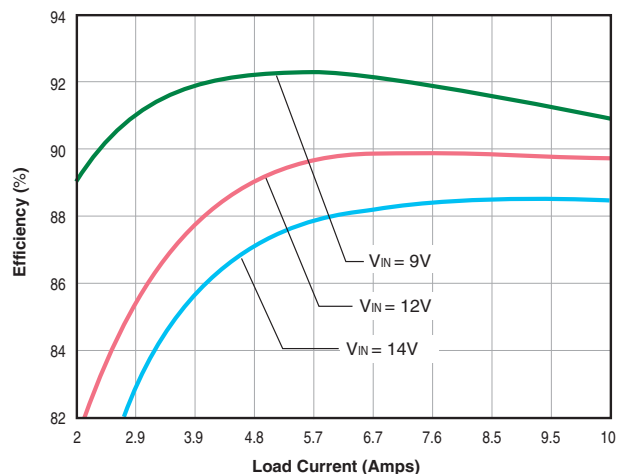

LSN-T/10-D12
Efficiency vs. Line Voltage and Load Current @ 25°C, V_{out} = 1V

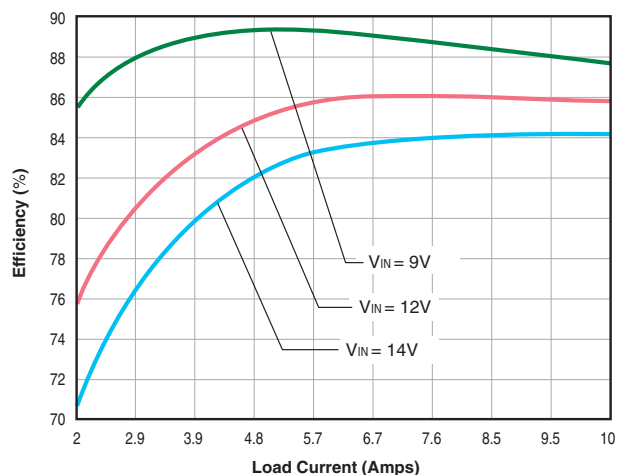

LSN-T/10-D12
Efficiency vs. Line Voltage and Load Current @ 25°C, V_{out} = 1.8V

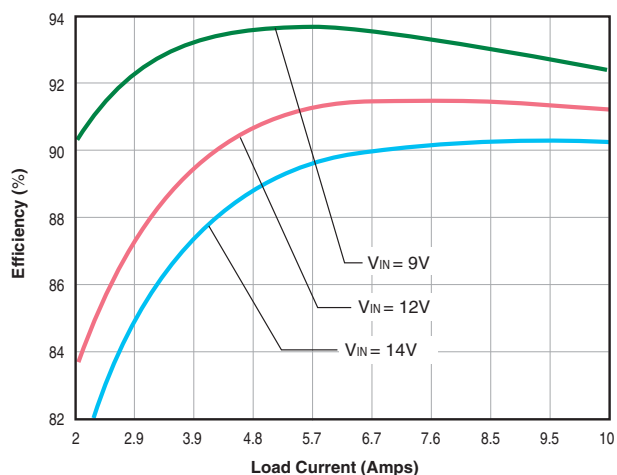

LSN-T/10-D12
Efficiency vs. Line Voltage and Load Current @ 25°C, V_{out} = 1.2V

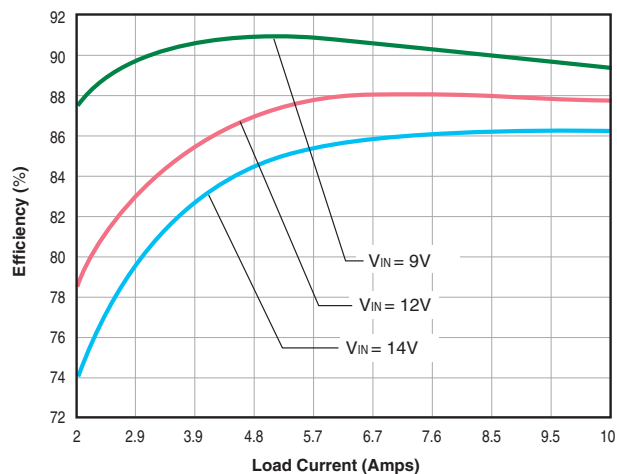

LSN-T/10-D12
Efficiency vs. Line Voltage and Load Current @ 25°C, V_{out} = 2.5V

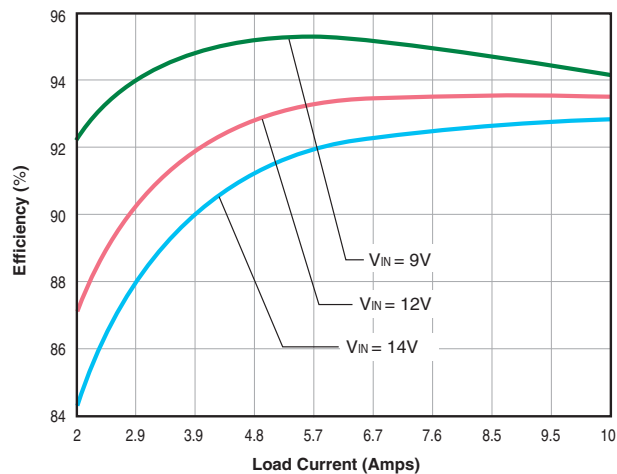

TYPICAL PERFORMANCE CURVES FOR LSN D12 SIP SERIES

LSN-T/10-D12
Efficiency vs. Line Voltage and Load Current @ 25°C, V_{out} = 3.3V

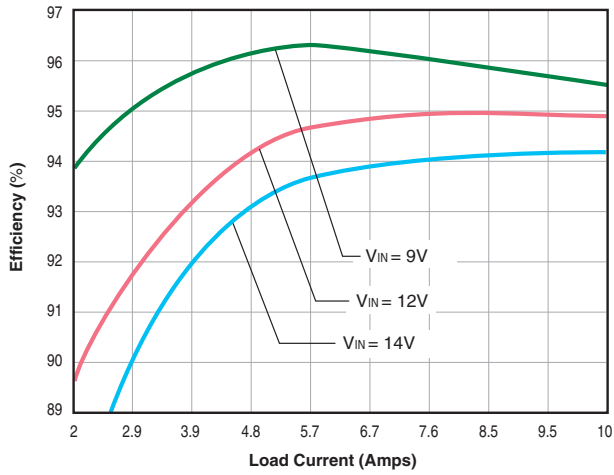

LSN-T/10-D12
Efficiency vs. Line Voltage and Load Current @ 25°C, V_{out} = 5V

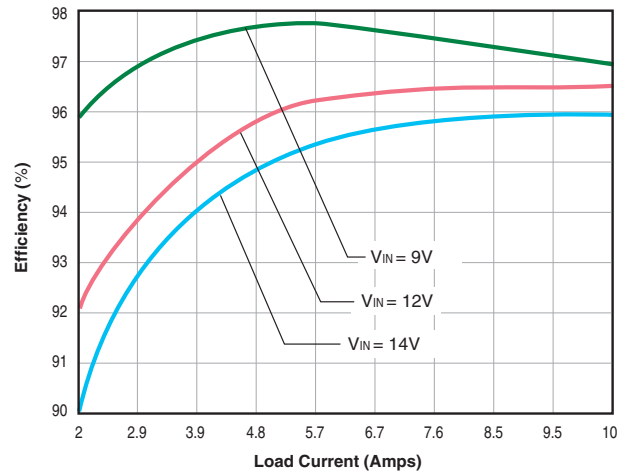

TYPICAL PERFORMANCE CURVES FOR LSN D12 SIP SERIES

LSN-T/10-D12 Output Current vs. Ambient Temperature
Vertical mount, $V_{OUT} = 0.75V$ to $1.5V$, air flow direction is longitudinal

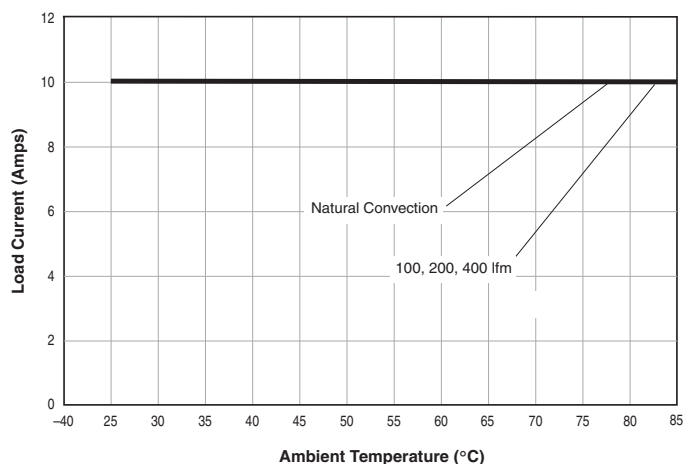

LSN-T/10-D12 Output Current vs. Ambient Temperature
Vertical mount, $V_{OUT} = 3.3V$, air flow direction is longitudinal

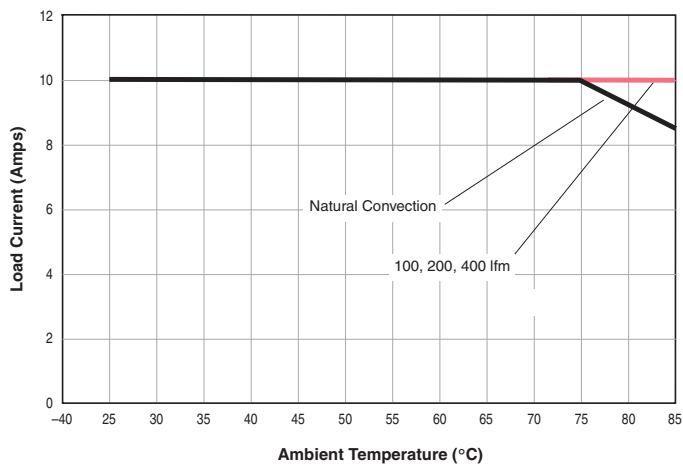

LSN-T/10-D12 Output Current vs. Ambient Temperature
Vertical mount, $V_{OUT} = 1.8V$, air flow direction is longitudinal

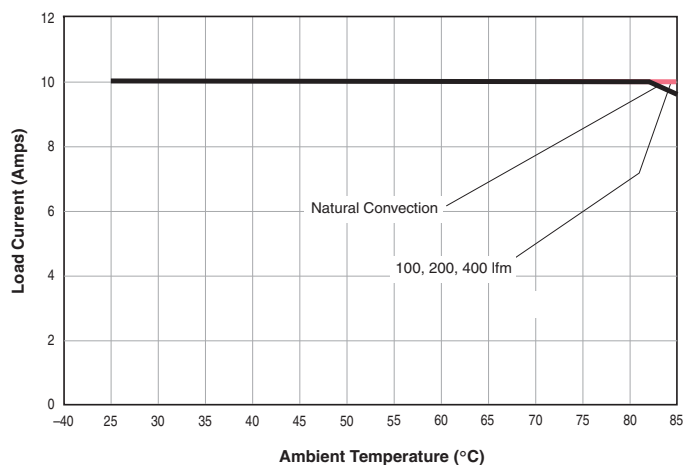

LSN-T/10-D12J Input Current vs. Ambient Temperature
Vertical mount, $V_{OUT} = 5V$, air flow direction is longitudinal

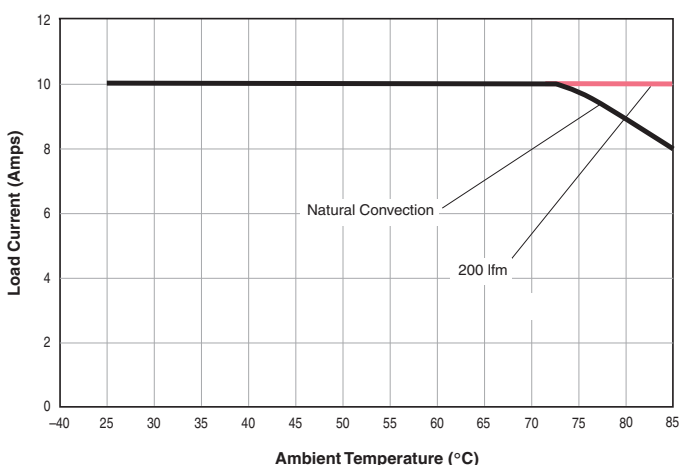

LSN-T/10-D12 Output Current vs. Ambient Temperature
Vertical mount, $V_{OUT} = 2.5V$, air flow direction is longitudinal

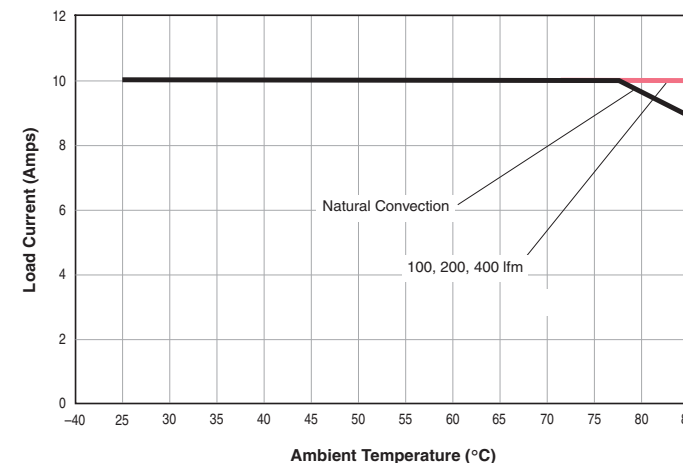

Note: For all derating curves, longitudinal airflow direction from pin 11 to pin 1.

TYPICAL PERFORMANCE CURVES FOR LSN D12 SIP SERIES

Power On From VIN
(VIN = 12V, VOUT = 5V, IOUT = 10A)

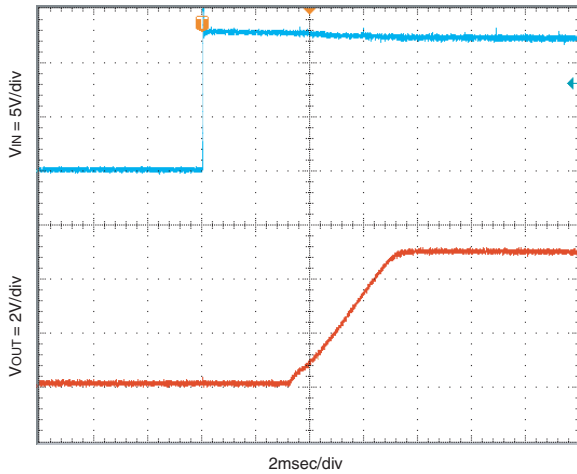

Power On From Enable
(VIN = 12V, VOUT = 5V, IOUT = 10A)

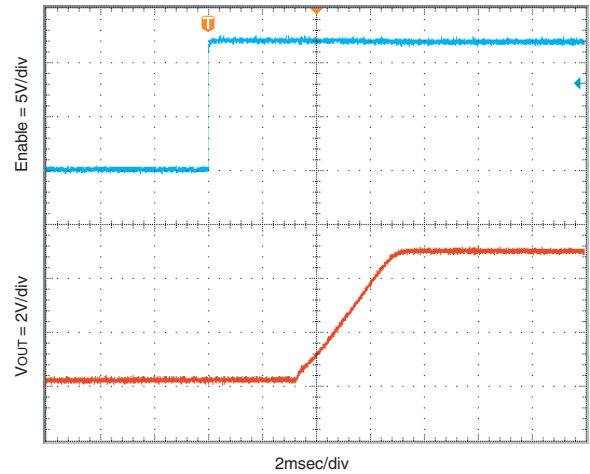

Power On From VIN With 13 x 470µF Poscap Loading
(VOUT = 5V, VIN = 12V, IOUT = 10A)

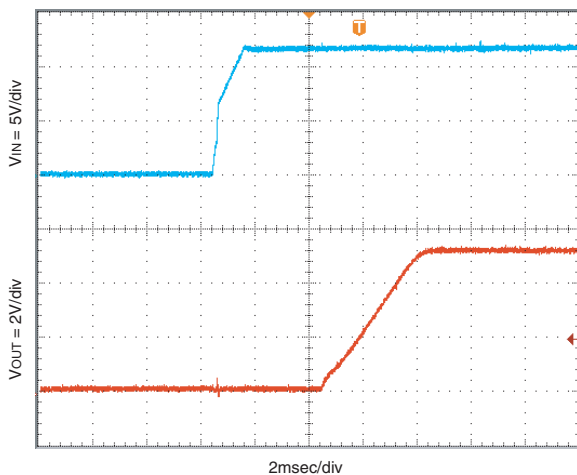

Pre-Bias Startup
(VOUT = 2.5V, Pre-Bias = 1.2V, IOUT = 1.5A)

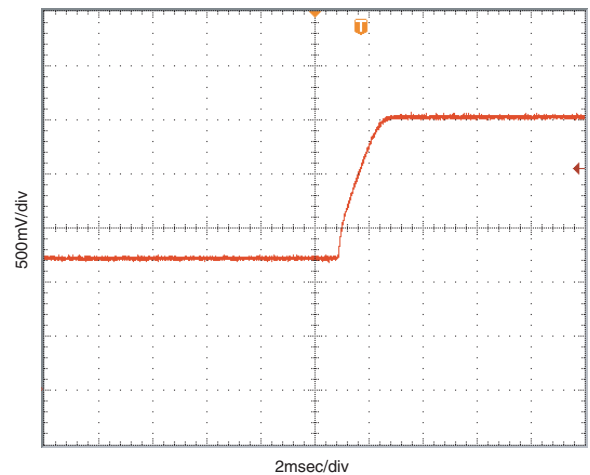

Output Ripple Noise
(VIN = 12V, VOUT = 2.5V, IOUT = 10A, COUT = 10µF Tantalum || 1µF ceramic)

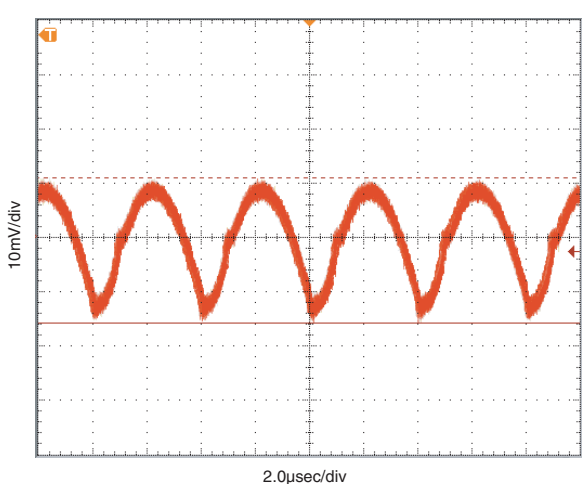

Output Ripple Noise
(VIN = 12V, VOUT = 5V, IOUT = 10A, COUT = 10µF Tantalum || 1µF ceramic)

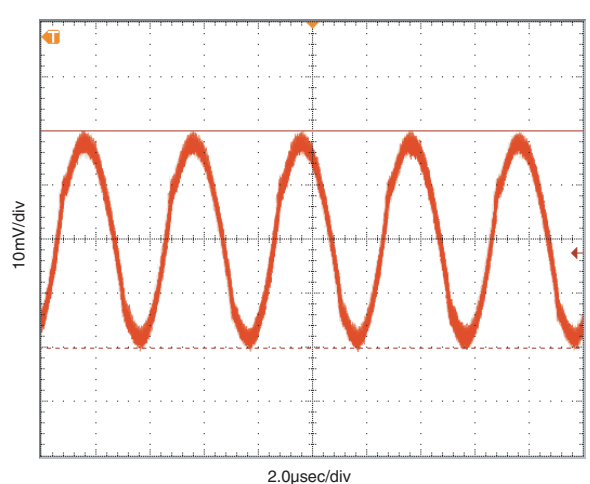

TYPICAL PERFORMANCE CURVES FOR LSN D12 SIP SERIES

Dynamic Load Response
(100-50% Load Step, $V_{IN} = 12V$, $V_{OUT} = 5V$)

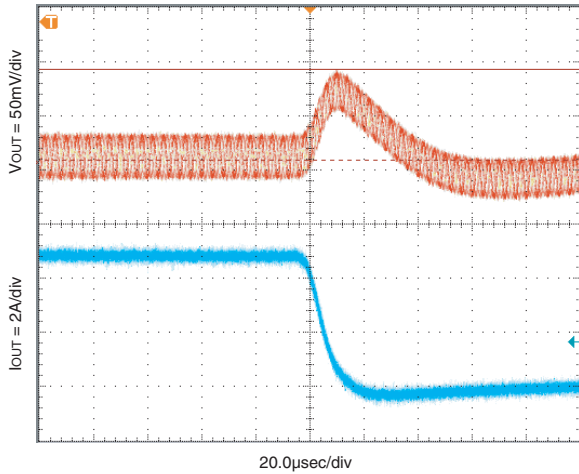

Dynamic Load Response
(50-100% Load Step, $V_{IN} = 12V$, $V_{OUT} = 5V$)

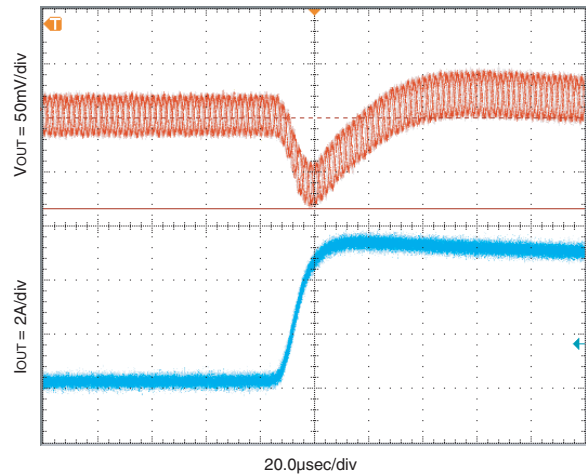

Dynamic Load Response
(100-50% Load Step, $V_{IN} = 12V$, $V_{OUT} = 5V$, $C_{OUT} = 2 @ 150\mu F$ polymer)

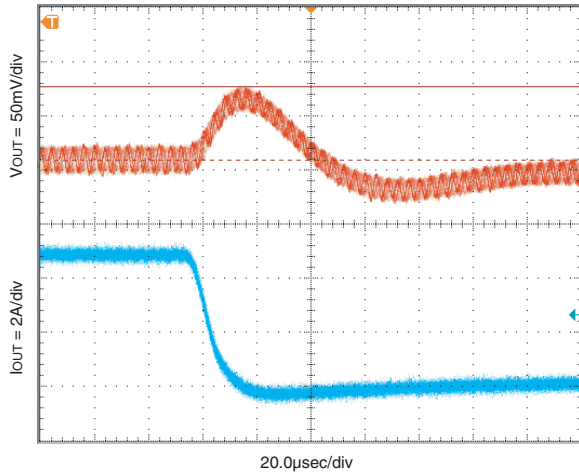

Dynamic Load Response
(50-100% Load Step, $V_{IN} = 12V$, $V_{OUT} = 5V$, $C_{OUT} = 2 @ 150\mu F$ polymer)

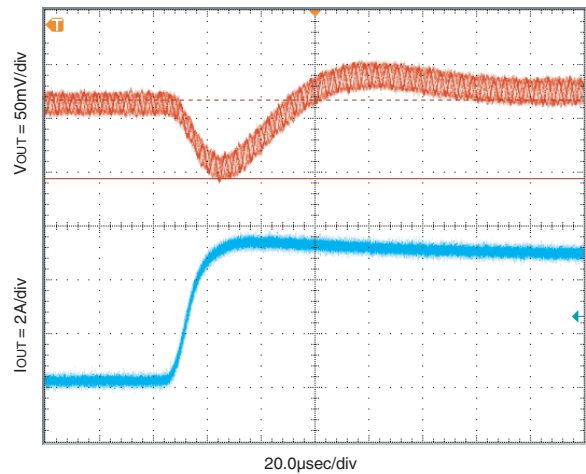

Short Circuit Current
($V_{IN} = 12V$, $V_{OUT} = 0.75V$)

