

**PLEASE CHECK WWW.MOLEX.COM FOR LATEST PART INFORMATION**

**Part Number:** [0512160500](#)  
**Status:** **Active**  
**Description:** 2.00mm (.079") Pitch Wire-to-Board and Wire-to-Wire Receptacle Housing, Positive Lock, 5 Circuits

**Documents:**

<a href="#">3D Model</a>	<a href="#">Product Specification PS-51216-006 (PDF)</a>
<a href="#">Drawing (PDF)</a>	<a href="#">Product Specification PS-51216-007 (PDF)</a>
<a href="#">Product Specification PS-51216-005 (PDF)</a>	<a href="#">RoHS Certificate of Compliance (PDF)</a>

**General**

Product Family	Crimp Housings
Series	<a href="#">51216</a>
Product Name	N/A

**Physical**

Circuits (maximum)	5
Color - Resin	Natural
Gender	Female
Glow-Wire Compliant	No
Material - Resin	Polyester
Number of Rows	1
Packaging Type	Bag
Panel Mount	No
Pitch - Mating Interface (in)	0.079 In
Pitch - Mating Interface (mm)	2.00 mm
Stackable	No
Temperature Range - Operating	-25°C to +85°C

**Material Info**

**Reference - Drawing Numbers**

Product Specification	PS-51216-005, PS-51216-006, PS-51216-007, RPS-51216-003, RPS-51216-004, RPS-51216-005, RPS-51216-006, RPS-51216-007, RPS-51216-008, RPS-51216-009, RPS-51216-010, RPS-51216-011, RPS-51216-012
Sales Drawing	SD-51216-004

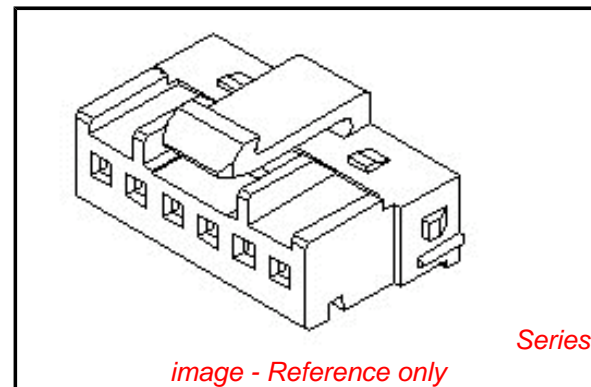

**EU RoHS**

**ELV and RoHS Compliant**  
**REACH SVHC**  
**Contains SVHC: No**  
**Halogen-Free**  
**Status**

**China RoHS**



**Not Halogen-Free**

**Need more information on product environmental compliance?**

Email [productcompliance@molex.com](mailto:productcompliance@molex.com)  
 For a multiple part number RoHS Certificate of Compliance, [click here](#)

Please visit the [Contact Us](#) section for any non-product compliance questions.

**Search Parts in this Series**

[51216Series](#)

**Mates With**

[51227](#)

**Use With**

[51217](#) , [59370](#)

**PLEASE CHECK WWW.MOLEX.COM FOR LATEST PART INFORMATION**

注記  
NOTES

- △1 適合ターミナル : 59370シリーズ  
APPLICABLE TERMINAL : 59370 SERIES
- △2 適合リテーナー : 51217シリーズ  
APPLICABLE RETAINER : 51217 SERIES
- 3. 嵌合相手 : 55487シリーズ  
MATE WITH : 55487 SERIES
- △4 偶数極に適用。  
APPLY EVEN CIRCUIT PRODUCTS.
- △5 4~15極に適用。  
APPLY 4-15 CIRCUITS.
- △6 5~15極に適用。  
APPLY 5-15 CIRCUITS.

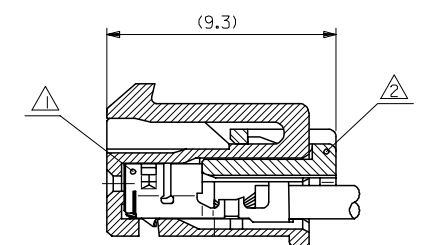

ターミナル及びリテーナー装着状態図  
TERMINAL & RETAINER ASSEMBLY DRAWING

30.9	29.3	7.4	3.7	28	31.8	51216-1500	15	
28.9	27.3			26	29.8	-1400	14	
26.9	25.3			24	27.8	-1300	13	
24.9	23.3			22	25.8	-1200	12	
22.9	21.3			20	23.8	-1100	11	
20.9	19.3			18	21.8	-1000	10	
18.9	17.3			16	19.8	-0900	9	
16.9	15.3			14	17.8	-0800	8	
14.9	13.3			12	15.8	-0700	7	
12.9	11.3			10	13.8	-0600	6	
10.9	9.3	7.4		8	11.8	-0500	5	
8.9	7.3			6	9.8	-0400	4	
6.9				3.7	4	7.8	-0300	3
4.9				2.2	2	5.8	51216-0200	2
F	E	D	C	B	A	MATERIAL NO.	CKT.	

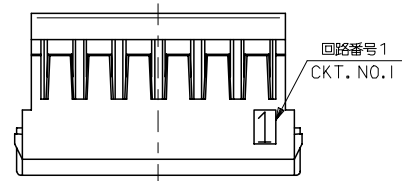

VIEW "H"

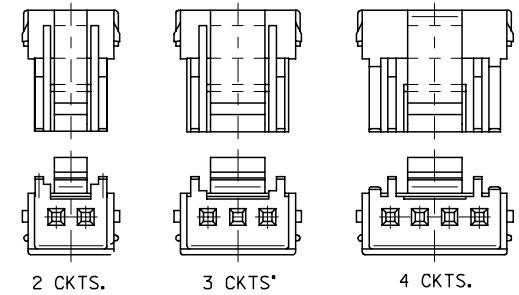
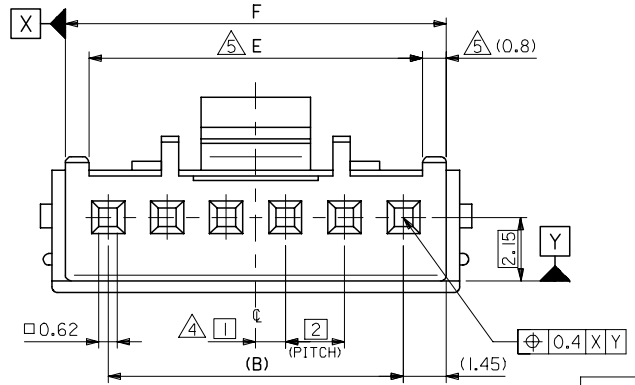
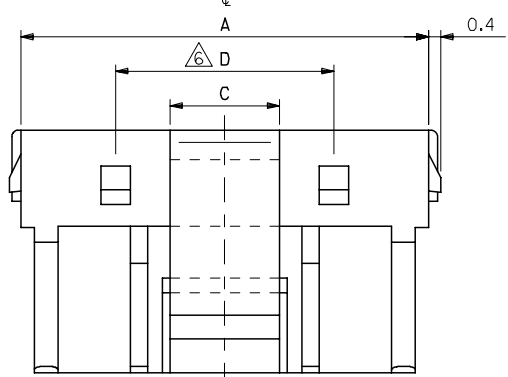
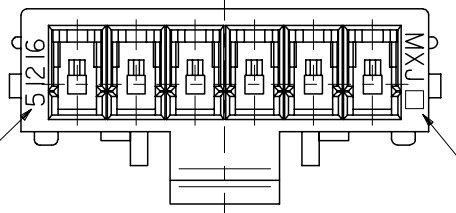
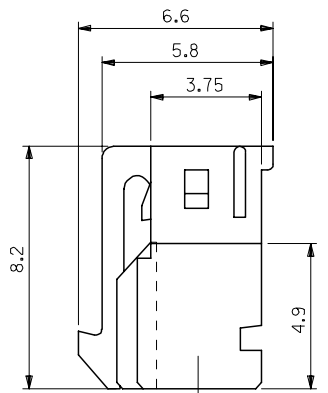

LAYOUT OF EACH CKTS.

GENERAL TOLERANCES (UNLESS SPECIFIED)

10 UNDER	±0.2
10 OVER 30 UNDER	±0.25
30 OVER	±0.3
ANGULAR	±3 °

DRAFT WHERE APPLICABLE MUST REMAIN WITHIN DIMENSIONS

DIMENSION STYLE MM ONLY	
DRAWN BY T. YASUI	DATE '00/2/22
CHECKED BY T. YAMAGUCHI	DATE '00/2/22
APPROVED BY M. FUKUSHIMA	DATE '00/2/22
MATERIAL NO.	

SCALE ---	DESIGN UNITS METRIC	THIRD ANGLE PROJECTION
TITLE 2.0MM WIRE TO BOARD RECEPTACLE HOUSING		
MOLEX MOLEX INCORPORATED		
ENTER PART SD-51216-004	DOCUMENT NO.	SHEET NO. 1 OF 1
SIZE A3 THIS DRAWING CONTAINS INFORMATION THAT IS PROPRIETARY TO MOLEX INCORPORATED AND SHOULD NOT BE USED WITHOUT WRITTEN PERMISSION		