

**PLEASE CHECK WWW.MOLEX.COM FOR LATEST PART INFORMATION**

**Part Number:** [0712510001](#)  
**Status:** **Active**  
**Description:** 1.27mm (.050") Pitch DIMM Socket, Vertical, Multiple Keys, Plastic Peg, 168 Circuits, 3.3V Standard DRAM

**Documents:**

[3D Model](#) [Product Specification PS-71243-9999 \(PDF\)](#)  
[Drawing \(PDF\)](#) [RoHS Certificate of Compliance \(PDF\)](#)

**Agency Certification**

CSA LR19980  
 UL E29179

**General**

Product Family Memory Module Sockets  
 Series [71251](#)  
 Comments Function Key Center, Voltage Key Center  
 Component Type Memory Module  
 JEDEC Outline MO-161  
 Product Name DIMM

**Physical**

Circuits (Loaded) 168  
 Circuits (maximum) 168  
 Color - Resin Black, Natural  
 Durability (mating cycles max) 25  
 Entry Angle Vertical (Top Entry)  
 Flammability 94V-0  
 Function Key Center  
 Keying to Mating Part Yes  
 Material - Metal Phosphor Bronze  
 Material - Plating Mating Gold  
 Material - Plating Termination Tin  
 Material - Resin High Temperature Thermoplastic  
 PC Tail Length (in) 0.127 In  
 PC Tail Length (mm) 3.23 mm  
 PCB Locator Yes  
 PCB Retention Yes  
 PCB Thickness Recommended (in) 0.062 In  
 PCB Thickness Recommended (mm) 1.57 mm  
 Packaging Type Tray  
 Pitch - Mating Interface (in) 0.050 In  
 Pitch - Mating Interface (mm) 1.27 mm  
 Pitch - Term. Interface (in) 0.050 In  
 Pitch - Term. Interface (mm) 1.27 mm  
 Plating min: Mating (µin) 2  
 Plating min: Mating (µm) 0.05  
 Plating min: Termination (µin) 150  
 Plating min: Termination (µm) 3.81  
 Temperature Range - Operating -40°C to +85°C  
 Termination Interface: Style Through Hole

**Electrical**

Current - Maximum per Contact 1A  
 Voltage - Maximum 100V AC (RMS)/DC  
 Voltage Key Center

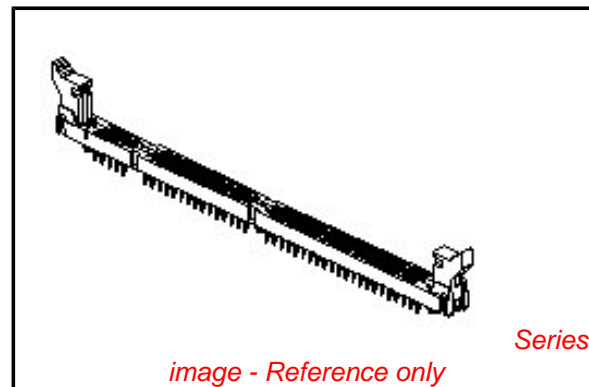

*image - Reference only*

**EU RoHS**

**ELV and RoHS  
 Compliant**  
**REACH SVHC  
 Contains SVHC: No  
 Halogen-Free  
 Status**

**China RoHS**



**Need more information on product  
 environmental compliance?**

Email [productcompliance@molex.com](mailto:productcompliance@molex.com)  
 For a multiple part number RoHS Certificate of  
 Compliance, [click here](#)

Please visit the [Contact Us](#) section for any  
 non-product compliance questions.

**Search Parts in this Series**

[71251Series](#)

**Mates With**

JEDEC MO-161 modules

**Solder Process Data**

Lead-free Process Capability

Wave Capable (TH only)

**Material Info****Reference - Drawing Numbers**

Product Specification

PS-71243-9999

Sales Drawing

SDA-71251-0\*\*\*

This document was generated on 04/13/2010

**PLEASE CHECK [WWW.MOLEX.COM](http://WWW.MOLEX.COM) FOR LATEST PART INFORMATION**

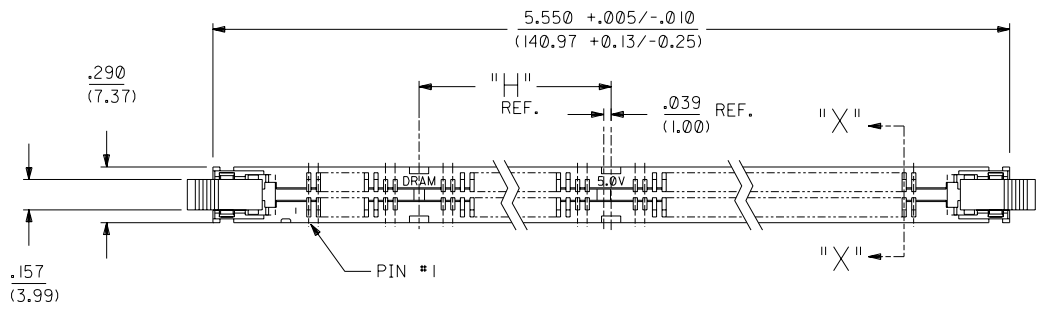

- NOTES:
- CARD SLOT ACCEPTS  $.050 \pm .004$  (1.27  $\pm 0.10$ ) MODULE THICKNESS. (MEASURED OVER P.C. PADS).
  - ALL PEGS ARE INTERFERENCE FITS TO PCB UNLESS NOTED ON THE DWG.
  - REFER TO PRODUCT SPEC PS-71243-9999 FOR PERFORMANCE SPECIFICATIONS.
  - PRODUCT IS PACKAGED IN TRAYS.
  - RECOMMENDED MODULE LAYOUT SHALL BE PER JEDEC MO-161.
  - RECOMMENDED PLATING ON MODULE PADS: 30 MICROINCH/(0.76 MICROMETER) MINIMUM HARD GOLD (Au) OVER 79 MICROINCH/(2.0 MICROMETER) MINIMUM NICKEL (Ni).
  - SEE CHART FOR HOLE SIZE AND PRESENCE AND PLATING OPTION.
  - PRODUCT WILL HAVE DATE CODE STAMPED ON SIDE OF HOUSING.

MATERIALS:  
 HOUSING - GLASS FILLED LIQUID CRYSTAL POLYMER (LCP), UL 94V-0, COLOR: BLACK.  
 TERMINAL - PHOSPHOR BRONZE  
 LATCHES - GLASS FILLED HIGH TEMPERATURE NYLON, UL 94V-0, COLOR: IVORY.

PLATING:  
 CONTACT AREA: OPTION A: GOLD (Au) FLASH; THICKNESS=2-10 MICROINCH/(0.05-0.25 (0.05-0.25 MICROMETER), OVER PALLADIUM-NICKEL (Pd-Ni); THICKNESS=30 MICROINCH/(0.76 MICROMETER) MINIMUM.  
 OPTION B: GOLD (Au) FLASH; THICKNESS=2-10 MICROINCH/(0.05-0.25 MICROMETER), OVER PALLADIUM-NICKEL (Pd-Ni); THICKNESS=20 MICROINCH/(0.51 MICROMETER) MINIMUM.

SOLDER TAILS: TIN (Sn); THICKNESS=150 MICROINCH/(3.81 MICROMETER) MINIMUM.  
 UNDERPLATE: NICKEL (Ni) OVER ENTIRE CONTACT.

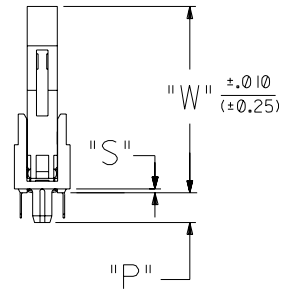

NOTE FOR LEAD FREE CONVERSION:  
 THE PRIMARY SHIPPING CARTON WILL BE LABELED "COMPLIANT TO RoHS DIRECTIVE 2002/95/EC AND ELV ANNEX II OF DIRECTIVE 2000/53/EC". CARTONS WITHOUT THIS LABEL MAY CONTAIN PRODUCT WITH LEAD.

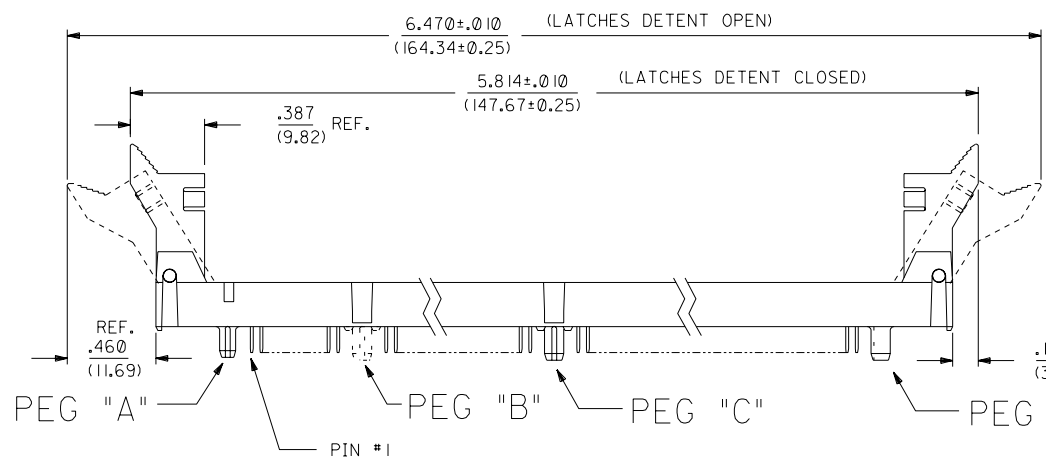

71251-0004 SHOWN

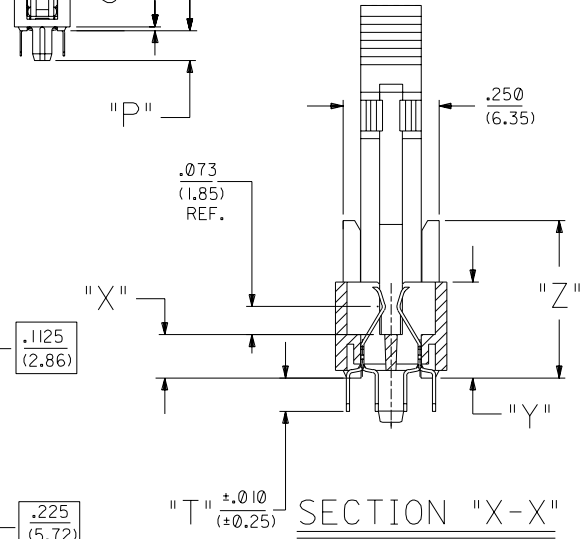

SCALE 4:1

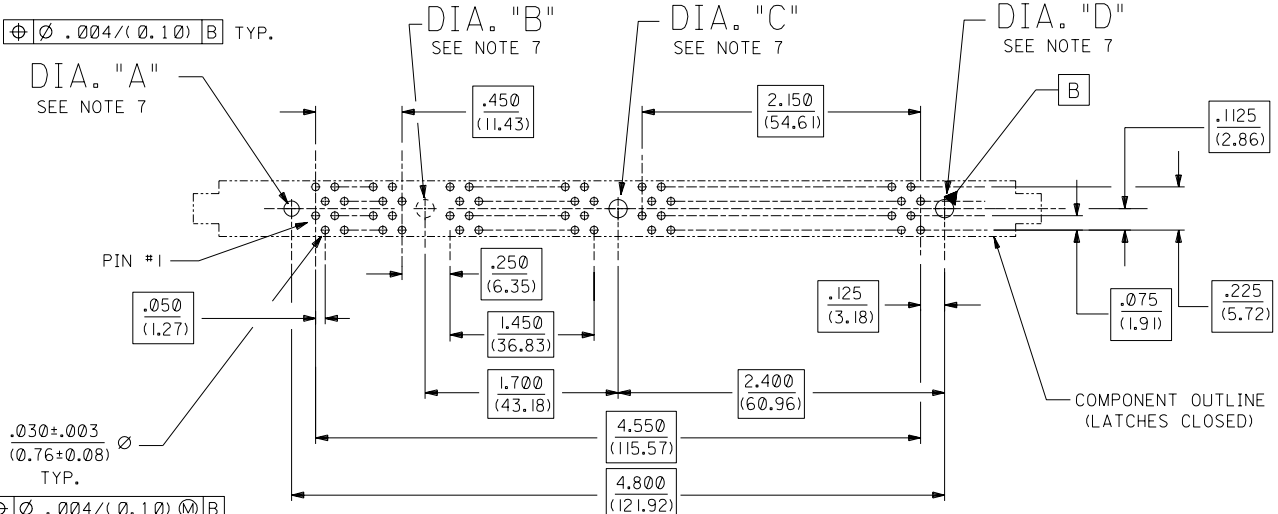

RECOMMENDED P.C. BOARD HOLE PATTERN (CONNECTOR SIDE)

H1	ADD LEAD FREE NOTE ECR# UC2004-1732 DMORGAN 04/03/09
H	RELEASE -0027 ECR# UD2000-1151 DMORGAN 00/05/19
H	RELEASE -0027 ECR# UD2000-1151 DMORGAN 00/05/19
G	CHG Sn-Pb THICKNESS ECR# UD1999-0454 DMORGAN 99/08/09
F3	REVISED PER ECR# U80435 97-8-8 LAURX
F2	REVISED PER ECR# U71162 97-4-15 LAURX
F1	REVISED PER ECR# U70361 96-10-9 LAURX
F	REVISED PER ECR# U61133 96-9-25 LAURX
E1	REVISED PER ECR# U60836 1-19-96 JCL
E	REVISED PER ECR# U60682 12-7-95 JCL
D2	REVISED PER ECR# U60452 10-10-95 JCL
D1	REVISED PER ECR# U60361 9-18-95 JCL
D	REVISED PER ECR# U51288 8-4-95 JCL

DIMENSIONS SHOWN (METRIC) INCH UNLESS OTHERWISE SPECIFIED TOLERANCES: ANGULAR $\pm 1/2^\circ$		REVISE ONLY ON CAD SYSTEM	
3 PLAGE $\pm .005$	INCH	TITLE	
2 PLAGE $\pm \dots \pm 0.13$	METRIC	.050/(1.27) PITCH MULTI-KEY	
1 PLAGE $\dots \pm 0.25$		168 CKT DIMM RAM ASSY	
DRAFT WHERE APPLICABLE MUST REMAIN WITHIN DIMENSIONS		17.8mm LATCH SALES DWG	
DRWG. BY DCB	CHK'D. BY DCB	FILE NAME	SHEET NO. DATE
APPR'D. BY DCB	SCALE 2:1	ST125101 DGN	MOLEX INCORPORATED U.S.A. 1 OF 3 10/10/94
PART NO. DRWG. NO.		SEE CHART SDA-71251-0***	
MFG, SH, REV. LTR. REVISIONS		THIS DRAWING CONTAINS INFORMATION THAT IS PROPRIETARY TO MOLEX INC. AND SHOULD NOT BE USED WITHOUT WRITTEN PERMISSION	

PART NUMBER	COLOR	DESCRIPTION	FUNCTION KEY	VOLTAGE KEY	DIA. "A"	DIA. "B"	DIA. "C"	DIA. "D"	DIM. "H"	DIM. "P"	DIM. "S"	DIM. "T"	DIM. "W"	DIM. "X"	DIM. "Y"	DIM. "Z"	CONTACT AREA PLATING
71251-0001	BLACK	3.3 VOLT STD DRAM	CENTER	CENTER	.080±.002 (2.03±0.05)	NONE	.093 +.003/-0.00 (2.36+0.08/-0.00)	.093 +.003/-0.00 (2.36+0.08/-0.00)	1.700 (43.18)	.155 (3.94)	.020 (0.51)	.127 (3.23)	.970 (24.64)	.113 (2.87)	.250 (6.35)	.410 (10.41)	OPTION A
71251-0004	BLACK	5.0 VOLT STD DRAM	CENTER	OFFSET LEFT	.080±.002 (2.03±0.05)	NONE	.093 +.003/-0.00 (2.36+0.08/-0.00)	.093 +.003/-0.00 (2.36+0.08/-0.00)	1.700 (43.18)	.155 (3.94)	.020 (0.51)	.127 (3.23)	.970 (24.64)	.113 (2.87)	.250 (6.35)	.410 (10.41)	OPTION A
71251-0012	BLACK	3.3 VOLT UNBUFFERED	OFFSET RIGHT	CENTER	.080±.002 (2.03±0.05)	NONE	.093 +.003/-0.00 (2.36+0.08/-0.00)	.093 +.003/-0.00 (2.36+0.08/-0.00)	1.661 (42.19)	.155 (3.94)	.020 (0.51)	.127 (3.23)	.970 (24.64)	.113 (2.87)	.250 (6.35)	.410 (10.41)	OPTION A
71251-0013	BLACK	5.0 VOLT UNBUFFERED	OFFSET RIGHT	OFFSET LEFT	.080±.002 (2.03±0.05)	NONE	.093 +.003/-0.00 (2.36+0.08/-0.00)	.093 +.003/-0.00 (2.36+0.08/-0.00)	1.661 (42.19)	.155 (3.94)	.020 (0.51)	.127 (3.23)	.970 (24.64)	.113 (2.87)	.250 (6.35)	.410 (10.41)	OPTION A
71251-0016	BLACK	3.3 VOLT SYNCHRONOUS	OFFSET LEFT	CENTER	.080±.002 (2.03±0.05)	NONE	.093 +.003/-0.00 (2.36+0.08/-0.00)	.093 +.003/-0.00 (2.36+0.08/-0.00)	1.739 (44.17)	.155 (3.94)	.020 (0.51)	.127 (3.23)	.970 (24.64)	.113 (2.87)	.250 (6.35)	.410 (10.41)	OPTION A
71251-0017	BLACK	5.0 VOLT SYNCHRONOUS	OFFSET LEFT	OFFSET LEFT	.080±.002 (2.03±0.05)	NONE	.093 +.003/-0.00 (2.36+0.08/-0.00)	.093 +.003/-0.00 (2.36+0.08/-0.00)	1.739 (44.17)	.155 (3.94)	.020 (0.51)	.127 (3.23)	.970 (24.64)	.113 (2.87)	.250 (6.35)	.410 (10.41)	OPTION A

NOTES:

1. STRAIGHTNESS OF MODULE APPLIES TO THE AREA FROM THE BOTTOM OF THE CARD UP .157/(4.00).
2. IF TIE BARS ARE ATTACHED TO PADS, THE TIE BAR SHOULD BE ON AN INTERNAL LAYER, SO THAT THE REMNANT CANNOT CAUSE DAMAGE TO THE CONTACTS.

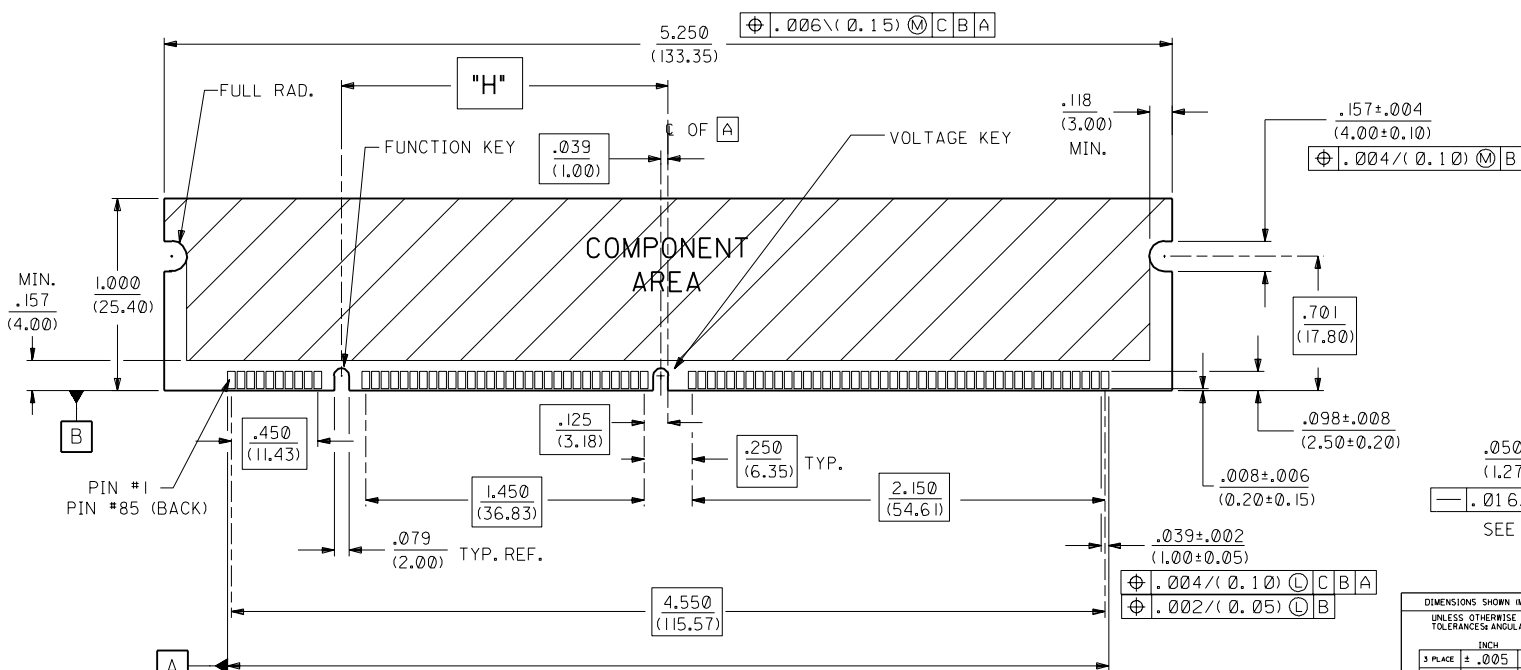
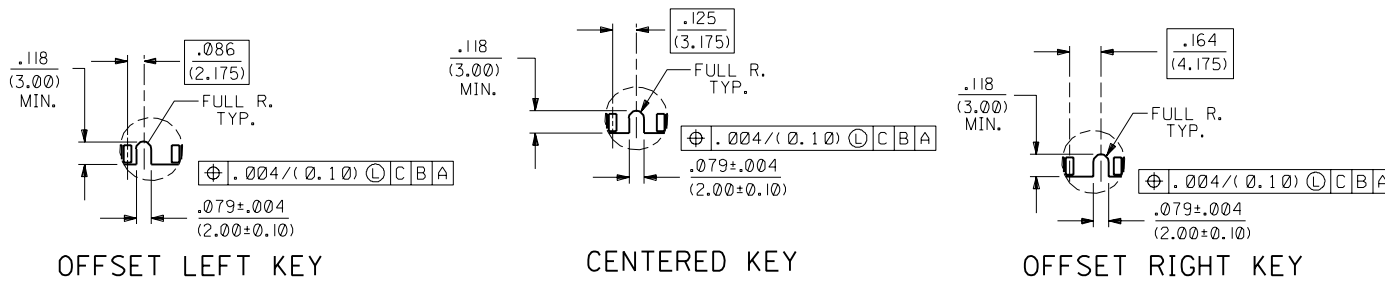

F3	SEE SHEET I
F2	SEE SHEET I
F1	SEE SHEET I
F	SEE SHEET I
E1	SEE SHEET I
E	SEE SHEET I
D2	SEE SHEET I
D1	SEE SHEET I
D	SEE SHEET I
C	SEE SHEET I
B1	SEE SHEET I
B	SEE SHEET I
A	SEE SHEET I

DIMENSIONS SHOWN (METRIC) INCH UNLESS OTHERWISE SPECIFIED TOLERANCES ANGULAR ± 1/2°		TITLE .050/(1.27) PITCH MULTI-KEY 168 CKT DIMM RAM ASSY 17.8mm LATCH SALES DWG.	
3 PLACE ± .005	INCH	DATE	10/10/94
2 PLACE ± .01	METRIC	SHEET NO.	2
1 PLACE --- ± 0.25		MOLEX INCORPORATED	
DRAFT WHERE APPLICABLE MUST REMAIN WITHIN DIMENSIONS		L1SLEJLL 60532 U.S.A.	
DRWG. NO.	DCB	CHK'D BY	DCB
FILE NAME	SEE CHART	APP'D BY	DCB
PART NO. SDA-71251-0...		SCALE 2: 1	
THIS DRAWING CONTAINS INFORMATION THAT IS PROPRIETARY TO MOLEX INC. AND SHOULD NOT BE USED WITHOUT WRITTEN PERMISSION.		DIV. CP	

RECOMMENDED MODULE LAYOUT  
168 CKT 5.0V DRAM SHOWN

13		12		11		10		9		8		7		6		71251		4		3		2		1	
PART NUMBER	COLOR	DESCRIPTION	FUNCTION KEY	VOLTAGE KEY	DIA. "A"	DIA. "B"	DIA. "C"	DIA. "D"	DIM. "H"	DIM. "P"	DIM. "S"	DIM. "T"	DIM. "W"	DIM. "X"	DIM. "Y"	DIM. "Z"	CONTACT AREA PLATING								
71251-0001	BLACK	3.3 VOLT STD DRAM	SEE SHEET 2																						OPTION A
71251-0002	BLACK	3.3 VOLT STD DRAM	CENTER	CENTER	NONE	$\frac{.093 + .003 / -.000}{(2.36 + 0.08 / -.000)}$	$\frac{.093 + .003 / -.000}{(2.36 + 0.08 / -.000)}$	NONE	1.700 (43.18)	.155 (3.94)	.020 (0.51)	.127 (3.23)	.970 (24.64)	.113 (2.87)	.250 (6.35)	.410 (10.41)									OPTION A
71251-0003	BLACK	5.0 VOLT STD DRAM	CENTER	OFFSET LEFT	NONE	$\frac{.093 + .003 / -.000}{(2.36 + 0.08 / -.000)}$	$\frac{.093 + .003 / -.000}{(2.36 + 0.08 / -.000)}$	NONE	1.700 (43.18)	.155 (3.94)	.020 (0.51)	.127 (3.23)	.970 (24.64)	.113 (2.87)	.250 (6.35)	.410 (10.41)									OPTION A
71251-0004	BLACK	5.0 VOLT STD DRAM	SEE SHEET 2																						OPTION A
71251-0005	BLACK	5.0 VOLT UNBUFFERED	OFFSET RIGHT	OFFSET LEFT	$\frac{.080 \pm .002}{(2.03 \pm 0.05)}$	NONE	NONE	$\frac{.080 \pm .002}{(2.03 \pm 0.05)}$	1.661 (42.19)	.125 (3.18)	.035 (0.89)	.102 (2.59)	.985 (25.02)	.128 (3.25)	.265 (6.73)	.425 (10.79)									OPTION A
71251-0006	BLACK	5.0 VOLT STD DRAM	CENTER	OFFSET LEFT	$\frac{.080 \pm .002}{(2.03 \pm 0.05)}$	NONE	$\frac{.093 + .003 / -.000}{(2.36 + 0.08 / -.000)}$	$\frac{.080 \pm .002}{(2.03 \pm 0.05)}$	1.700 (43.18)	.155 (3.94)	.020 (0.51)	.127 (3.23)	.970 (24.64)	.113 (2.87)	.250 (6.35)	.410 (10.41)									OPTION A
71251-0007	BLACK	3.3 VOLT STD DRAM	CENTER	CENTER	$\frac{.080 \pm .002}{(2.03 \pm 0.05)}$	NONE	$\frac{.080 \pm .002}{(2.03 \pm 0.05)}$	$\frac{.080 \pm .002}{(2.03 \pm 0.05)}$	1.700 (43.18)	.140 (3.56)	.020 (0.51)	.127 (3.23)	.970 (24.64)	.113 (2.87)	.250 (6.35)	.410 (10.41)									OPTION A
71251-0008	BLACK	5.0 VOLT STD DRAM	CENTER	OFFSET LEFT	NONE	$\frac{.093 + .003 / -.000}{(2.36 + 0.08 / -.000)}$	$\frac{.093 + .003 / -.000}{(2.36 + 0.08 / -.000)}$	$\frac{.093 + .003 / -.000}{(2.36 + 0.08 / -.000)}$	1.700 (43.18)	.155 (3.94)	.020 (0.51)	.127 (3.23)	.970 (24.64)	.113 (2.87)	.250 (6.35)	.410 (10.41)									OPTION A
71251-0009	BLACK	5.0 VOLT STD DRAM	CENTER	OFFSET LEFT	$\frac{.080 \pm .002}{(2.03 \pm 0.05)}$	NONE	NONE	$\frac{.080 \pm .002}{(2.03 \pm 0.05)}$	1.700 (43.18)	.125 (3.18)	.035 (0.89)	.102 (2.59)	.985 (25.02)	.128 (3.25)	.265 (6.73)	.425 (10.79)									OPTION A
71251-0010	BEIGE	3.3 VOLT STD DRAM	CENTER	CENTER	$\frac{.080 \pm .002}{(2.03 \pm 0.05)}$	NONE	NONE	$\frac{.080 \pm .002}{(2.03 \pm 0.05)}$	1.700 (43.18)	.125 (3.18)	.035 (0.89)	.112 (2.84)	.985 (25.02)	.128 (3.25)	.265 (6.73)	.425 (10.79)									OPTION A
71251-0011	BLACK	3.3 VOLT STD DRAM	CENTER	CENTER	$\frac{.093 + .003 / -.000}{(2.36 + 0.08 / -.000)}$	NONE	$\frac{.093 + .003 / -.000}{(2.36 + 0.08 / -.000)}$	$\frac{.093 + .003 / -.000}{(2.36 + 0.08 / -.000)}$	1.700 (43.18)	.155 (3.94)	.020 (0.51)	.127 (3.23)	.970 (24.64)	.113 (2.87)	.250 (6.35)	.410 (10.41)									OPTION A
71251-0012	BLACK	3.3 VOLT UNBUFFERED	SEE SHEET 2																						OPTION A
71251-0013	BLACK	5.0 VOLT UNBUFFERED	SEE SHEET 2																						OPTION A
71251-0014	BLACK	3.3 VOLT UNBUFFERED	OFFSET RIGHT	CENTER	$\frac{.080 \pm .002}{(2.03 \pm 0.05)}$	NONE	NONE	$\frac{.080 \pm .002}{(2.03 \pm 0.05)}$	1.661 (42.19)	.125 (3.18)	.035 (0.89)	.112 (2.84)	.985 (25.02)	.128 (3.25)	.265 (6.73)	.425 (10.79)									OPTION A
71251-0015	BLACK	3.3 VOLT STD DRAM	CENTER	CENTER	$\frac{.080 \pm .002}{(2.03 \pm 0.05)}$	NONE	$\frac{.093 + .003 / -.000}{(2.36 + 0.08 / -.000)}$	$\frac{.093 + .003 / -.000}{(2.36 + 0.08 / -.000)}$	1.700 (43.18)	.155 (3.94)	.020 (0.51)	.117 (2.97)	.970 (24.64)	.113 (2.87)	.250 (6.35)	.410 (10.41)									OPTION A
71251-0016	BLACK	3.3 VOLT SYNCHRONOUS	SEE SHEET 2																						OPTION A
71251-0017	BLACK	5.0 VOLT SYNCHRONOUS	SEE SHEET 2																						OPTION A
71251-0018	BLACK	3.3 VOLT UNBUFFERED	OFFSET RIGHT	CENTER	$\frac{.093 + .003 / -.000}{(2.36 + 0.08 / -.000)}$	NONE	$\frac{.093 + .003 / -.000}{(2.36 + 0.08 / -.000)}$	$\frac{.093 + .003 / -.000}{(2.36 + 0.08 / -.000)}$	1.661 (42.19)	.140 (3.56)	.035 (0.89)	.102 (2.59)	.985 (25.02)	.128 (3.25)	.265 (6.73)	.425 (10.79)									OPTION A
71251-0019	BLACK	5.0 VOLT STD DRAM	CENTER	OFFSET LEFT	NONE	$\frac{.093 + .003 / -.000}{(2.36 + 0.08 / -.000)}$	$\frac{.093 + .003 / -.000}{(2.36 + 0.08 / -.000)}$	NONE	1.700 (43.18)	.155 (3.94)	.020 (0.51)	.127 (3.23)	.970 (24.64)	.113 (2.87)	.250 (6.35)	.410 (10.41)									OPTION B
71251-0020	BLACK	3.3 VOLT STD DRAM	CENTER	CENTER	$\frac{.080 \pm .002}{(2.03 \pm 0.05)}$	NONE	$\frac{.080 \pm .002}{(2.03 \pm 0.05)}$	$\frac{.080 \pm .002}{(2.03 \pm 0.05)}$	1.700 (43.18)	.140 (3.56)	.020 (0.51)	.127 (3.23)	.970 (24.64)	.113 (2.87)	.250 (6.35)	.410 (10.41)									OPTION B
71251-0021	BLACK	3.3 VOLT STD DRAM	CENTER	CENTER	$\frac{.080 \pm .002}{(2.03 \pm 0.05)}$	NONE	$\frac{.093 + .003 / -.000}{(2.36 + 0.08 / -.000)}$	$\frac{.093 + .003 / -.000}{(2.36 + 0.08 / -.000)}$	1.700 (43.18)	.155 (3.94)	.020 (0.51)	.127 (3.23)	.970 (24.64)	.113 (2.87)	.250 (6.35)	.410 (10.41)									OPTION B
71251-0022	BLACK	3.3 VOLT UNBUFFERED	OFFSET RIGHT	CENTER	$\frac{.080 \pm .002}{(2.03 \pm 0.05)}$	NONE	$\frac{.093 + .003 / -.000}{(2.36 + 0.08 / -.000)}$	$\frac{.093 + .003 / -.000}{(2.36 + 0.08 / -.000)}$	1.661 (42.19)	.155 (3.94)	.020 (0.51)	.127 (3.23)	.970 (24.64)	.113 (2.87)	.250 (6.35)	.410 (10.41)									OPTION B
71251-0023	BLACK	3.3 VOLT UNBUFFERED	OFFSET RIGHT	CENTER	$\frac{.080 \pm .002}{(2.03 \pm 0.05)}$	NONE	NONE	$\frac{.080 \pm .002}{(2.03 \pm 0.05)}$	1.661 (42.19)	.125 (3.18)	.035 (0.89)	.102 (2.59)	.985 (25.02)	.128 (3.25)	.265 (6.73)	.425 (10.79)									OPTION A
71251-0024	BLACK	3.3 VOLT UNBUFFERED	OFFSET RIGHT	CENTER	$\frac{.080 \pm .002}{(2.03 \pm 0.05)}$	NONE	$\frac{.093 + .003 / -.000}{(2.36 + 0.08 / -.000)}$	$\frac{.093 + .003 / -.000}{(2.36 + 0.08 / -.000)}$	1.661 (42.19)	.155 (3.94)	.020 (0.51)	.105 (2.67)	.970 (24.64)	.113 (2.87)	.250 (6.35)	.410 (10.41)									OPTION A
71251-0026	BEIGE	3.3 VOLT STD DRAM	CENTER	CENTER	$\frac{.080 \pm .002}{(2.03 \pm 0.05)}$	NONE	NONE	$\frac{.080 \pm .002}{(2.03 \pm 0.05)}$	1.700 (43.18)	.125 (3.18)	.035 (0.89)	.090 (2.29)	.985 (25.02)	.128 (3.25)	.265 (6.73)	.425 (10.79)									OPTION A
71251-0027	BLACK	3.3 VOLT SYNCHRONOUS	OFFSET LEFT	CENTER	NONE	$\frac{.093 + .003 / -.000}{(2.36 + 0.08 / -.000)}$	$\frac{.093 + .003 / -.000}{(2.36 + 0.08 / -.000)}$	NONE	1.739 (44.17)	.155 (3.94)	.020 (0.51)	.127 (3.23)	.970 (24.64)	.113 (2.87)	.250 (6.35)	.410 (10.41)									OPTION A

DIMENSIONS SHOWN (METRIC) INCH UNLESS OTHERWISE SPECIFIED TOLERANCES ANGULAR ± 1/2°										REVISE ONLY ON CAD SYSTEM									
INCH METRIC										TITLE .050/(1.27) PITCH MULTI-KEY 168 CKT DIMM RAM ASSY 17.8mm LATCH SALES DWG.									
3 PLACE ± .005 ---										PART NO. 71251-0001									
2 PLACE ± .01 ± 0.13										MOLEX INCORPORATED SHEET NO. 3 DATE 12/07/95									
1 PLACE --- ± 0.25										DRAWN BY DCB									
DRAFT WHERE APPLICABLE MUST REMAIN WITHIN DIMENSIONS										SCALE 2:1									
H SEE SHEET 1										FILE NAME S7125103.DWG									
F3 SEE SHEET 1										DIV. CP									
LTR. REVISIONS										THIS DRAWING CONTAINS INFORMATION THAT IS PROPRIETARY TO MOLEX INC. AND SHOULD NOT BE USED WITHOUT WRITTEN PERMISSION									