

## Features

- 75  $\Omega$  Input / Output Match
- CTB: -80 dBc
- Noise Figure: 2.7 dB
- Gain: 14.8 dB
- Lead Free SOT-89 Package
- Halogen-Free “Green” Mold Compound
- 260°C Re-flow Compatible
- RoHS\* Compliant Version of MAAMSS0031

## Description

M/A-COM’s MAAMSS0041 CATV amplifier is a GaAs MMIC which exhibits low distortion in a lead-free surface mount plastic package. The MAAMSS0041 employs a monolithic single stage design featuring a convenient 75  $\Omega$  input/output impedance that minimizes the number of external components required.

The MAAMSS0041 provides low noise and high linearity. It is ideally suited for set top boxes, home gateways, and other broadband internet based appliances.

The MAAMSS0041 is fabricated using M/A-COM’s PHEMT process to realize low noise and low distortion. The process features full passivation for robust performance and reliability.

## Ordering Information<sup>1,2</sup>

Part Number	Package
MAAMSS0041	Lead Free SOT-89 Plastic Package
MAAMSS0041TR-3000	3000 Piece Tape and Reel
MAAMSS0041SMB	Sample Test Board

1. Reference Application Note M513 for reel size information.
2. All sample boards include 5 loose parts.

## Functional Schematic

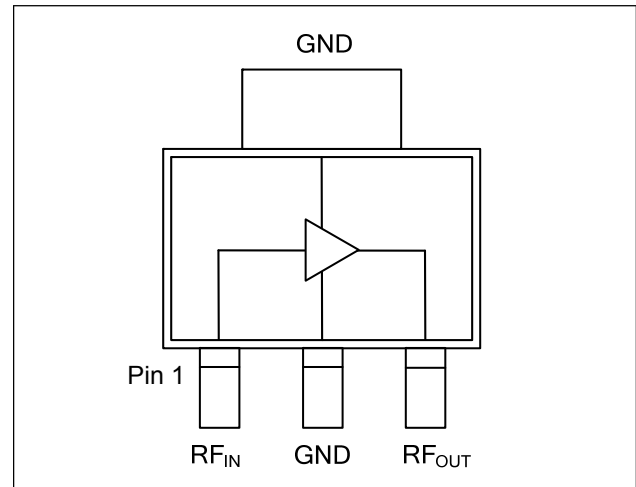

## Pin Configuration

Pin No.	Pin Name	Description
1	RF <sub>IN</sub>	RF Input
2	GND	Ground
3	RF <sub>OUT</sub>	RF Output / Drain Supply

## Absolute Maximum Ratings<sup>3,4,5</sup>

Parameter	Absolute Maximum
RF Input Power	15 dBm
Voltage	10.0 volts
Operating Temperature	-40°C to +85°C
Junction Temperature <sup>6</sup>	+150°C
Storage Temperature	-65°C to +150°C

3. Exceeding any one or combination of these limits may cause permanent damage to this device.
4. M/A-COM does not recommend sustained operation near these survivability limits.
5. These operating conditions will ensure MTTF > 1 x 10<sup>6</sup> hours.
6. Junction Temperature (T<sub>J</sub>) = T<sub>C</sub> +  $\Theta_{jc}$  \* (V \* I)  
Typical thermal resistance ( $\Theta_{jc}$ ) = 75° C/W.
  - a) For T<sub>C</sub> = 25°C,  
T<sub>J</sub> = 85°C @ 8 V, 100 mA
  - b) For T<sub>C</sub> = 85°C,  
T<sub>J</sub> = 139 °C @ 8 V, 90 mA

\* Restrictions on Hazardous Substances, European Union Directive 2002/95/EC.

**ADVANCED:** Data Sheets contain information regarding a product M/A-COM Technology Solutions is considering for development. Performance is based on target specifications, simulated results, and/or prototype measurements. Commitment to develop is not guaranteed.  
**PRELIMINARY:** Data Sheets contain information regarding a product M/A-COM Technology Solutions has under development. Performance is based on engineering tests. Specifications are typical. Mechanical outline has been fixed. Engineering samples and/or test data may be available. Commitment to produce in volume is not guaranteed.

• **North America** Tel: 800.366.2266 / Fax: 978.366.2266  
 • **Europe** Tel: 44.1908.574.200 / Fax: 44.1908.574.300  
 • **Asia/Pacific** Tel: 81.44.844.8296 / Fax: 81.44.844.8298  
 Visit [www.macomtech.com](http://www.macomtech.com) for additional data sheets and product information.

M/A-COM Technology Solutions Inc. and its affiliates reserve the right to make changes to the product(s) or information contained herein without notice.

**Electrical Specifications:  $T_A = 25^\circ\text{C}$ , Freq: 50 - 1000 MHz,  $V_{DD} = +8$  Volts,  $Z_0 = 75 \Omega$**

Parameter	Test Conditions	Units	Min.	Typ.	Max.
Gain		dB	14.0	14.8	16.0
Gain Flatness		dB	—	0.5	1.0
Noise Figure		dB	—	2.7	3.8
Input Return Loss		dB	—	20	—
Output Return Loss		dB	—	18	—
Output IP3	6 MHz Spacing, -10 dBm output per tone	dBm	—	36	—
Composite Triple Beat, CTB	132 channels, +23 dBmV/channel at the output.	dBc	—	-80	—
Composite Second Order, CSO	132 channels, +23 dBmV/channel at the output.	dBc	—	-70	—
P1dB		dBm	—	23	—
$I_{DD}$	+ 8 Volts	mA	—	100	130

### Schematic Including Off-Chip Components

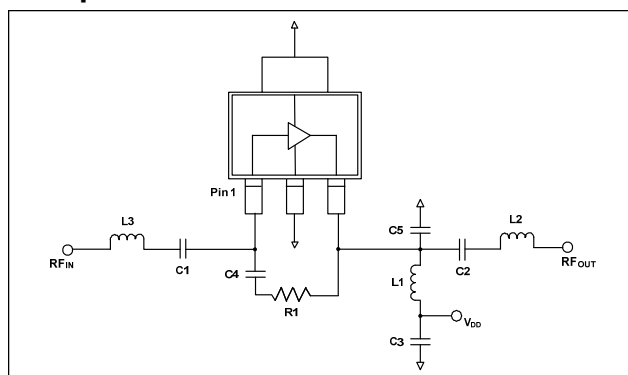

### Recommended Board Layout

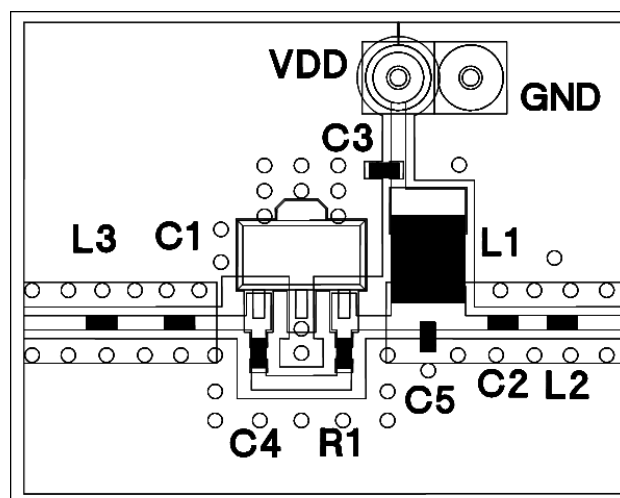

### Off-Chip Component Values

Component	Value	Package
C1 - C4	0.01 $\mu\text{F}$	0402
C5	0.5 pF	0402
L1 <sup>7</sup>	1000 nH	1210
L2	8.2 nH	0402
L3	5.6 nH	0402
R1	523 $\Omega$	0402

7. L1 supplied from EPCOS, part number B82422A1102K100.

## Typical Performance Curves

**Gain vs. Frequency over Temperature to 1 GHz**

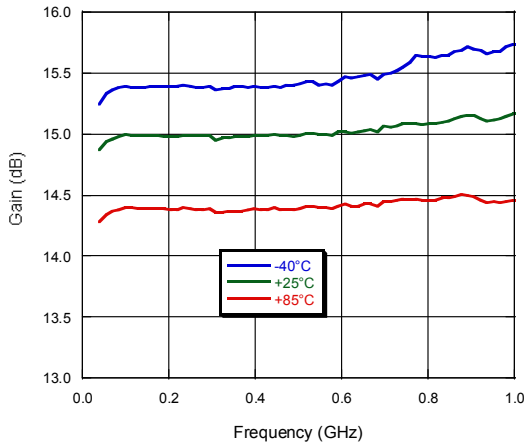

**Gain vs. Frequency over Temperature to 3 GHz**

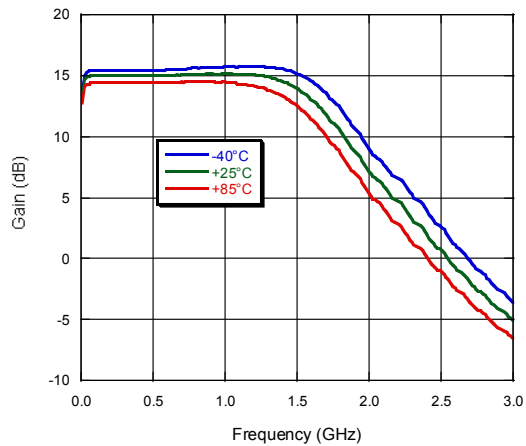

**Input Return Loss vs. Frequency over Temperature**

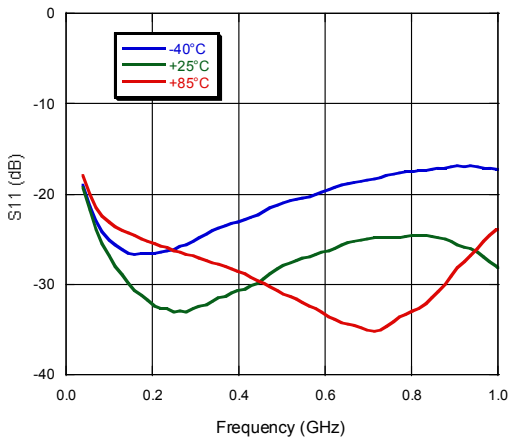

**Output Return Loss vs. Frequency over Temperature**

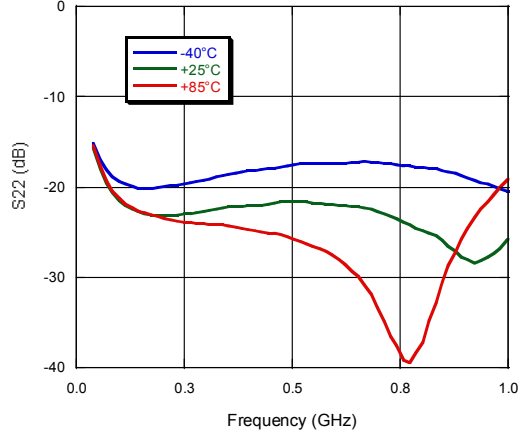

**Noise Figure vs. Frequency**

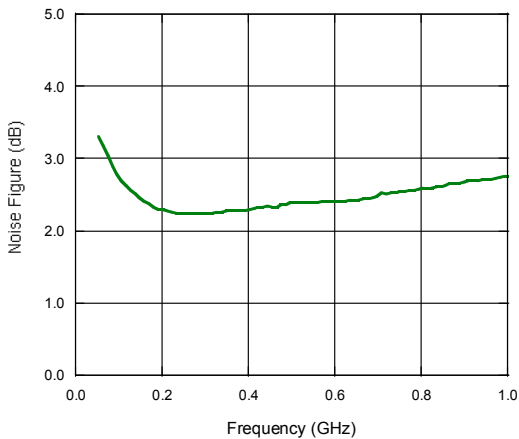

## Lead Free SOT-89 Plastic Package†

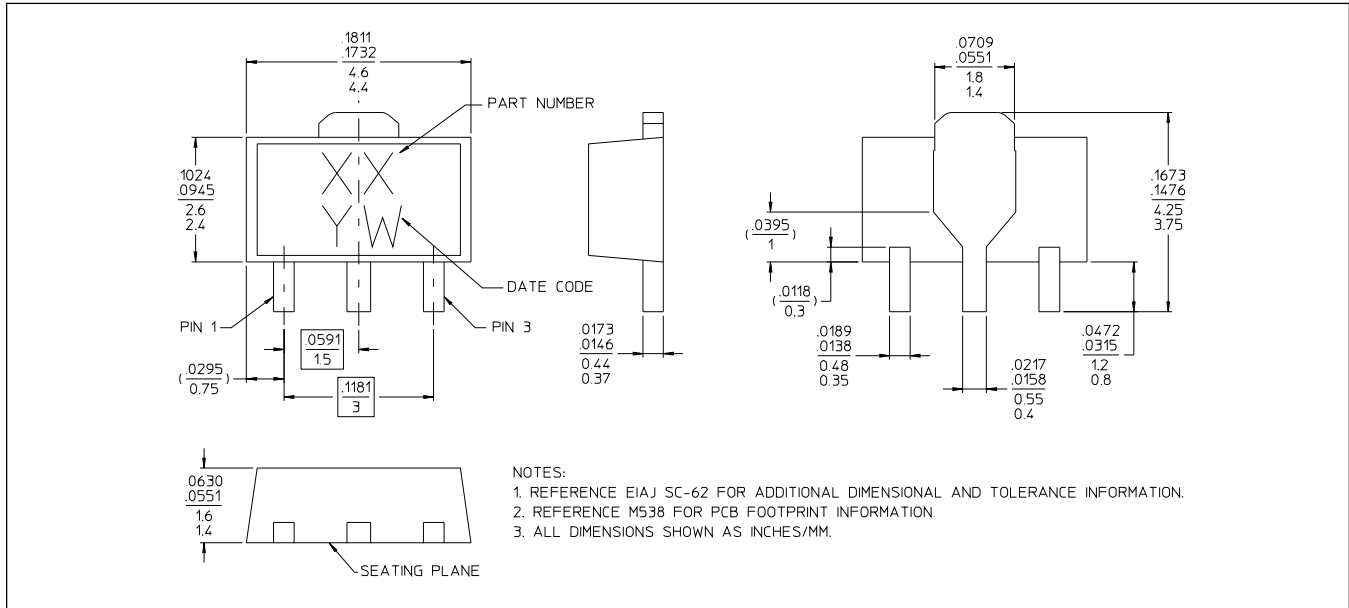

† Reference Application Note M538 for lead-free solder reflow recommendations.  
 Meets JEDEC moisture sensitivity level 1 requirements.  
 Plating is 100% matte tin over copper

## Handling Procedures

Please observe the following precautions to avoid damage:

## Static Sensitivity

Gallium Arsenide Integrated Circuits are sensitive to electrostatic discharge (ESD) and can be damaged by static electricity. Proper ESD control techniques should be used when handling these devices.