

# HS-2608

## ULV Intel® Celeron® Processor Embedded Engine Board

- CompactFlash • Mini PCI • SO-DIMM •
  - CRT/LVDS Panel • Dual LAN •
- Audio • ATA/33/66/100 • RS-232/422/485 •
  - 4 COM • USB • PC/104 • DOC •
  - WDT • Single +5V • H/W Monitor •
- Industrial Embedded Single Board computer •

## Copyright Disclaimers

The accuracy of contents in this manual has passed thorough checking and review before publishing. BOSER Technology Co., Ltd., the manufacturer and publisher, is not liable for any infringements of patents or other rights resulting from its use. The manufacturer will not be responsible for any direct, indirect, special, incidental or consequential damages arising from the use of this product or documentation, even if advised of the possibility of such damage(s).

This manual is copyrighted and BOSER Technology Co., Ltd. reserves all documentation rights. Unauthorized reproduction, transmission, translation, and storage of any form and means (i.e., electronic, mechanical, photocopying, recording) of this document, in whole or partly, is prohibited, unless granted permission by BOSER Technology Co., Ltd.

BOSER Technology Co., Ltd. reserves the right to change or improve the contents of this document without due notice. BOSER Technology Co., Ltd. assumes no responsibility for any errors or omissions that may appear in this manual, nor does it make any commitment to update the information contained herein.

## Trademarks

*BOSER is a registered trademark of BOSER Technology Co., Ltd.*

*ISB is a registered trademark of BOSER Technology Co., Ltd.*

*Intel is a registered trademark of Intel Corporation.*

*Award is a registered trademark of Award Software, Inc.*

*AMI is a registered trademark of AMI Software, Inc.*

*All other trademarks, products and or product names mentioned herein are mentioned for identification purposes only, and may be trademarks and/or registered trademarks of their respective companies or owners.*



**© Copyright 2006 BOSER Technology Co., Ltd.  
All Rights Reserved.  
Edition 2.3, November 16, 2006**

## Table of Contents

<b>Chapter 1</b>	<b>General Description.....</b>	<b>1</b>
1.1	Major Features .....	2
1.2	Specifications .....	3
1.3	Board Dimensions.....	4
<b>Chapter 2</b>	<b>Unpacking .....</b>	<b>5</b>
2.1	Opening the Delivery Package.....	5
2.2	Inspection.....	5
<b>Chapter 3</b>	<b>Hardware Installation .....</b>	<b>7</b>
3.1	Before Installation .....	7
3.2	Board Layout .....	8
3.3	Jumper List .....	9
3.4	Connector List .....	9
3.5	Configuring the CPU .....	10
3.6	System Memory .....	10
3.7	DiskOnChip™ Address Setting .....	10
3.8	VGA Controller .....	12
3.9	PCI E-IDE Drive Connector.....	14
3.10	Floppy Disk Drive Connector .....	15
3.11	Serial Port Connectors .....	16
3.12	Parallel Connector.....	19
3.13	Ethernet Connector .....	20
3.14	USB Connector.....	20
3.15	CMOS Data Clear.....	21
3.16	Power and Fan Connectors.....	21
3.17	Keyboard/Mouse Connectors .....	22
3.18	System Front Panel Connectors.....	22
3.19	Watchdog Timer .....	23
3.20	Mini PCI Connector .....	25
3.21	PC/104 Connectors .....	26
3.22	Audio Connectors .....	28
3.23	CompactFlash™ Connector.....	28
3.24	8-bit I/O Function.....	29

<b>Chapter 4</b>	<b>AMI BIOS Setup .....</b>	<b>33</b>
4.1	Starting Setup .....	33
4.2	Using Setup .....	34
4.3	Main Menu .....	35
4.4	Standard CMOS Setup .....	36
4.5	Advanced CMOS Setup .....	37
4.6	Advanced Chipset Setup .....	38
4.7	Power Management Setup .....	39
4.8	PCI / Plug and Play Setup .....	40
4.9	Peripheral Setup .....	41
4.10	Hardware Monitor Setup .....	42
4.11	Auto-Detect Hard Disks .....	42
4.12	Change Supervisor/User Password .....	43
4.13	Auto Configuration with Optimal Settings .....	44
4.14	Auto Configuration with Fail Safe Settings .....	45
4.15	Save Settings and Exit .....	46
4.16	Exit Without Saving .....	47
<b>Chapter 5</b>	<b>Software Utilities .....</b>	<b>49</b>
5.1	IDE Driver Installation .....	49
5.2	VGA Driver Installation .....	54
5.3	LAN Driver Installation .....	60
5.4	Audio Driver Installation .....	76

## Safety Instructions

Integrated circuits on computer boards are sensitive to static electricity. To avoid damaging chips from electrostatic discharge, observe the following precautions:

- Do not remove boards or integrated circuits from their anti-static packaging until you are ready to install them.
- Before handling a board or integrated circuit, touch an unpainted portion of the system unit chassis for a few seconds. This helps to discharge any static electricity on your body.
- Wear a wrist-grounding strap, available from most electronic component stores, when handling boards and components. Fasten the ALLIGATOR clip of the strap to the end of the shielded wire lead from a grounded object. Please wear and connect the strap before handle the HS-2608 to ensure harmlessly discharge any static electricity through the strap.
- Please use an anti-static pad when putting down any components or parts or tools outside the computer. You may also use an anti-static bag instead of the pad. Please inquire from your local supplier for additional assistance in finding the necessary anti-static gadgets.

**NOTE:** *DO NOT TOUCH THE BOARD OR ANY OTHER SENSITIVE COMPONENTS WITHOUT ALL NECESSARY ANTI-STATIC PROTECTIONS.*



# Chapter 1

## General Description

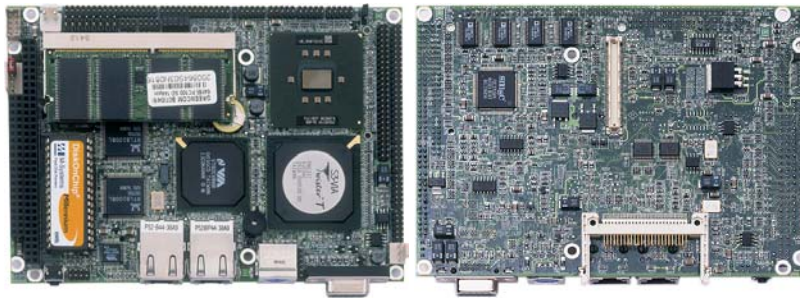

The HS-2608 v2.0 is a VIA VT8606 chipset-based board designed for Mini PCI Local Bus and use ULV Intel® Celeron® processor 400MHz/650MHz. These features combine and make the HS-2608 v2.0 an ideal all-in-one industrial single board computer. Additional features include an enhanced I/O with CF, CRT/LVDS, dual LAN, audio, 4 COM, and USB ports interfaces.

Its onboard ATA/33/66/100 to IDE drive interface architecture allows the HS-2608 v2.0 to support data transfers of 33, 66 or 100MB/sec. to one IDE drive connection. Designed with the VIA VT8606 core logic chipset, the board supports ULV Intel® Celeron® processor 400MHz/650MHz.

The VIA VT8606 with 32MB shared main memory supporting CRT/Panel displays up to 1280 x 1024 at 24bpp colors (CRT)/1024 x 768 at 18bpp colors (Panel). It also supports 18-bit dual channel LVDS interface.

System memory is also sufficient with the one SO-DIMM socket that can support up to 512MB.

Additional onboard connectors include an advanced USB port providing faster data transmission, a DOS-compatible DiskOnChip™ socket with a maximum capacity of 288MB. And two external RJ-45 connectors for 10/100 Based Ethernet use.

To ensure the reliability in an unmanned or standalone system, the Watchdog Timer (WDT) onboard HS-2608 v2.0 is designed with pure hardware that does not need the arithmetical functions of a real-time clock chip. If any program causes unexpected halts to the system, the onboard Watchdog Timer (WDT) will automatically reset the CPU or generate an interrupt to resolve such condition.

## 1.1 Major Features

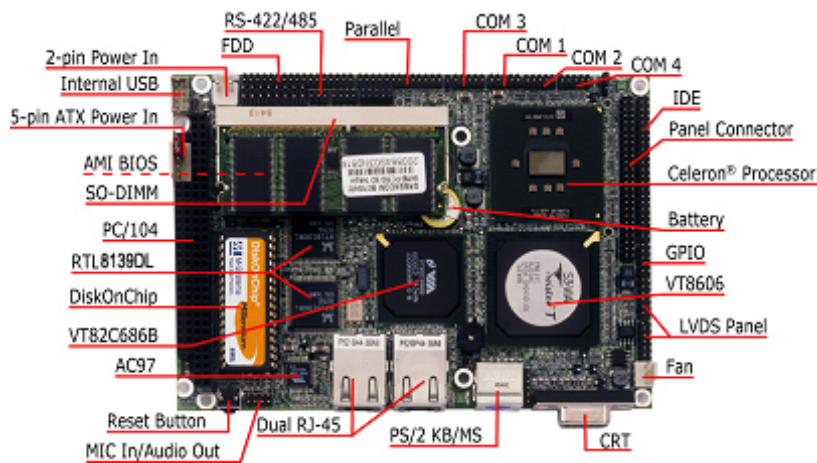

The HS-2608 v2.0 comes with the following features:

- ULV Intel® Celeron® processor 400MHz/650MHz
- One SO-DIMM socket with a max. capacity of 512MB
- VIA VT8606/VT82C686B system chipset
- VIA VT82C686B, SMC 37C669 super I/O chipset
- VIA VT8606 graphics controller
- 18-bit/36-bit LVDS Panel display interface
- Dual RealTek RTL8139DL LAN controller
- AC97 3D audio controller
- Fast PCI ATA/33/66/100 IDE controller
- CompactFlash card adapter, 4 COM, 2 USB, PC/104
- DOC socket supporting memory sizes of up to 288MB
- Single +5V power in
- Hardware Monitor function



## 1.2 Specifications

- **CPU:** ULV Intel® Celeron® M processor 400MHz/650MHz
- **Memory:** One SO-DIMM socket supporting up to 512MB
- **Chipset:** VIA VT8606/VT82C686B
- **I/O Chipset:** VIA VT82C686B, SMC 37C669
- **CompactFlash:** One, Type II IDE interface adapter
- **PCI Slot:** One, Type I mini PCI slot
- **8-bit I/O:** 8-bit input/output (parallel port)
- **VGA:** VIA VT8606 with 32MB shared main memory supporting CRT/Panel displays up to 1280 x 1024 at 24bpp colors (CRT)/1024 x 768 at 18bpp colors (Panel)
- **LVDS Panel:** Supports 18-bit single channel/36-bit dual channel LVDS interface
- **LAN:** Dual RealTek RTL8139DL 10/100 Based LAN
- **Audio:** AC97 3D audio controller
- **IDE:** One 2.0-pitch 44-pin IDE connector
- **FDD:** Supports up to two floppy disk drives
- **Parallel:** One enhanced bi-directional parallel port supporting SPP/ECP/EPP
- **Serial Port:** 16C550 UART-compatible RS-232/422/485 x 1 and RS-232 x 3 serial ports with 16-byte FIFO
- **USB:** 2 internal USB ports
- **PC/104:** PC/104 Bus connector for 16-bit ISA Bus
- **Keyboard/Mouse:** PS/2 6-pin Mini DIN or 6-pin header
- **DiskOnChip™:** DiskOnChip™ socket supporting memory sizes of up to 288MB
- **BIOS:** AMI PnP Flash BIOS
- **Watchdog Timer:** Sets 1/2/10/20/110/220 seconds activity trigger with Reset or NMI
- **CMOS:** Battery backup
- **Power In:** Single +5V power in
- **Temperature:** 0~+60°C (operating)
- **Hardware Monitor:** VIA VT82C686B
- **Board Size:** 14.5(L) x 10.2(W) cm

### 1.3 Board Dimensions

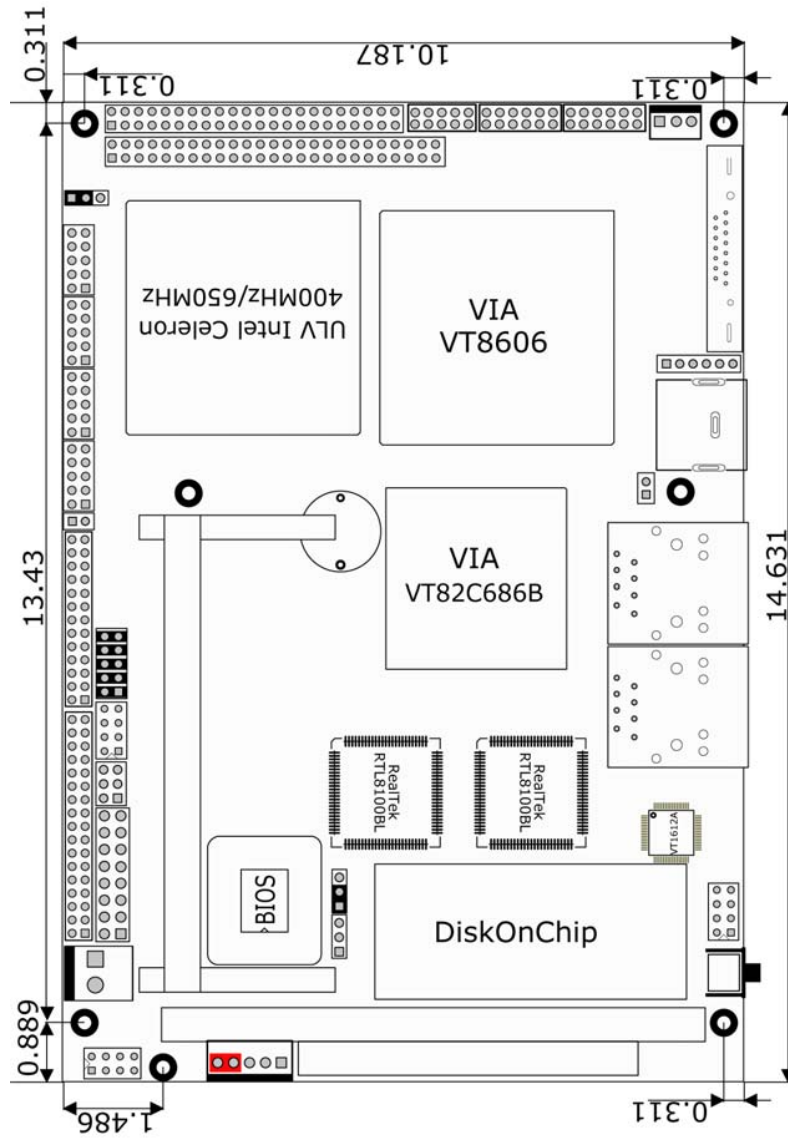

# Chapter 2

---

## Unpacking

### 2.1 Opening the Delivery Package

The HS-2608 v2.0 is packed in an anti-static bag. The board has components that are easily damaged by static electricity. Do not remove the anti-static wrapping until proper precautions have been taken. Safety Instructions in front of this manual describe anti-static precautions and procedures.

### 2.2 Inspection

After unpacking the board, place it on a raised surface and carefully inspect the board for any damage that might have occurred during shipment. Ground the board and exercise extreme care to prevent damage to the board from static electricity.

Integrated circuits will sometimes come out of their sockets during shipment. Examine all integrated circuits, particularly the BIOS, processor, memory modules, ROM-Disk, and keyboard controller chip to ensure that they are firmly seated. The HS-2608 v2.0 delivery package contains the following items:

- HS-2608 v2.0 Board x 1
- Utility CD Disk x 1
- Cables Package x 1
- Cooling Fan & Heat Sink x 1
- Jumper Bag x 1
- User's Manual



<b>Cables Package</b>	
<b>NO.</b>	<b>Description</b>
<b>1</b>	Keyboard/Mouse transfer cable x 1
<b>2</b>	One COM flat cable x 4
<b>3</b>	Parallel port flat cable x 1
<b>4</b>	ATA/100 IDE flat cable x 1
<b>5</b>	MIC/Audio flat cable x 1
<b>6</b>	Two USB flat cable with bracket x 1
<b>7</b>	Floppy flat cable x 1
<b>8</b>	Power In cable x 1

If you want to use ATA/66/100 IDE device, please purchase this cable separately.



<b>Optional Cable</b>	
<b>Part No.</b>	<b>Description</b>
<b>291-04010200G</b>	ATA/66/100 IDE cable for 2.0-pitch IDE connector

It is recommended that you keep all the parts of the delivery package intact and store them in a safe/dry place for any unforeseen event requiring the return shipment of the product. In case you discover any missing and/or damaged items from the list of items, please contact your dealer immediately.

# Chapter 3

---

## Hardware Installation

This chapter provides the information on how to install the hardware using the HS-2608 v2.0. This chapter also contains information related to jumper settings of switch, watchdog timer, and the DiskOnChip™ address selection etc.

### 3.1 Before Installation

After confirming your package contents, you are now ready to install your hardware. The following are important reminders and steps to take before you begin with your installation process.

1. Make sure that all jumper settings match their default settings and CMOS setup correctly. Refer to the sections on this chapter for the default settings of each jumper.
2. Go through the connections of all external devices and make sure that they are installed properly and configured correctly within the CMOS setup. Refer to the sections on this chapter for the detailed information on the connectors.
3. Keep the manual and diskette in good condition for future reference and use.

### 3.2 Board Layout

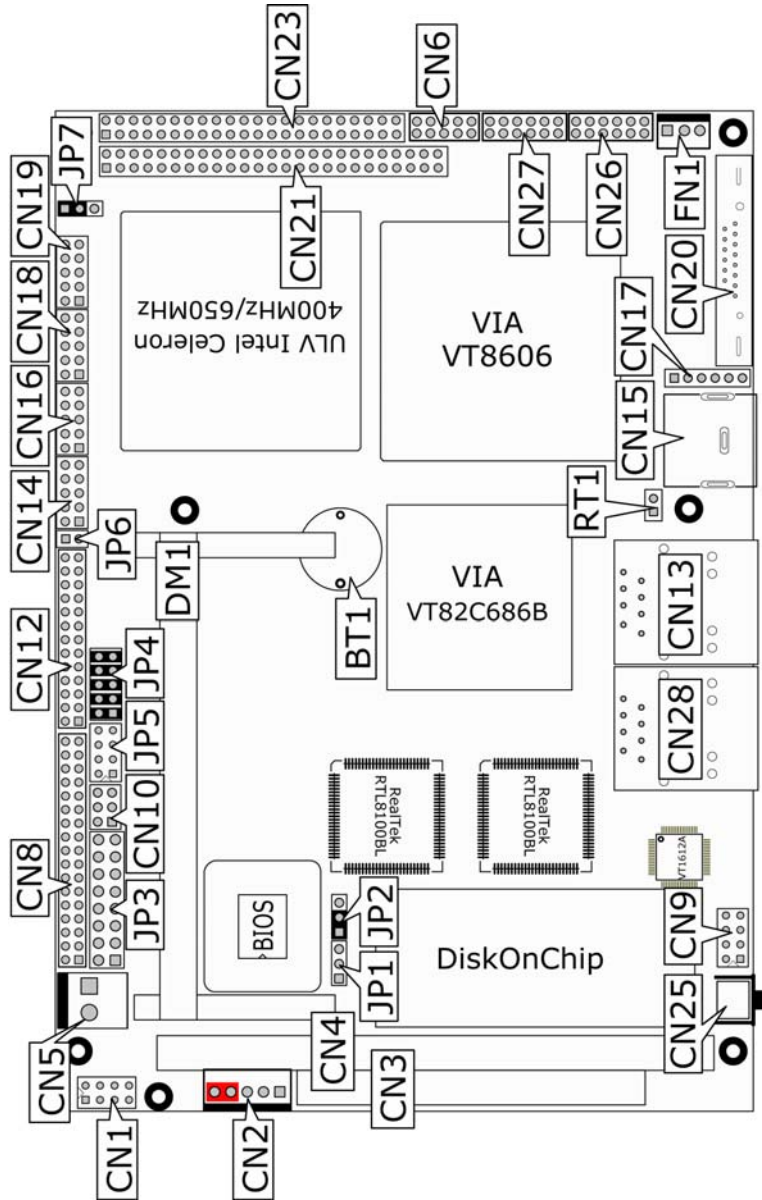

### 3.3 Jumper List

Jumper	Default Setting	Setting	Page
<b>JP1</b>	WDT Active Type Setting: <i>Disabled</i>	All Open	23
<b>JP2</b>	Clear CMOS: <i>Normal Operation</i>	Short 1-2	21
<b>JP4(1-4)</b>	DOC Address Select: <i>D000</i>	Short 1-2, 3-4	10
<b>JP4(5-10)</b>	WDT Timer Select: <i>1sec.</i>	Short 5-6, 7-8, 9-10	23
<b>JP5(7-8)</b>	RS-422/485 Receiver Enabled/Disabled Select: <i>Disabled</i>	Open	16
<b>JP6</b>	COM2 Use RS-232 or RS-422/485 Select: <i>RS-232</i>	Open	16
<b>JP7</b>	Panel Voltage Select: <i>+3.3V</i>	Short 1-2	12

### 3.4 Connector List

Connector	Definition	Page
<b>CN1</b>	Internal USB Connector	20
<b>CN2</b>	5-pin ATX Power In Connector	21
<b>CN3/CN4</b>	PC/104 40-pin/64-pin Connector	26
<b>CN5</b>	2-pin Power In Connector	21
<b>CN6</b>	8-bit I/O Connector	29
<b>CN8</b>	Floppy Connector	15
<b>CN9</b>	Line In/Audio Out Connector	28
<b>CN10</b>	RS-422/485 Connector (2x3 header)	16
<b>CN12</b>	Parallel Connector	19
<b>CN13/CN28</b>	RJ-45 Connector	20
<b>CN16/CN18/CN14/CN19</b>	COM 1~ COM 4 Connector (5x2 header)	16
<b>CN15</b>	PS/2 6-pin Mini DIN KB/MS Connector	22
<b>CN17</b>	6-pin KB/MS Connector	22
<b>CN20</b>	15-pin CRT Connector	12
<b>CN21</b>	50-pin Panel Connector	12
<b>CN23</b>	IDE Connector	14
<b>CN24</b>	CompactFlash Connector	28
<b>CN25</b>	External Reset Button	22
<b>CN26/CN27</b>	LVDS Panel Connector	12
<b>DM1</b>	SO-DIMM Socket	10
<b>FN1</b>	Fan Connector	21
<b>JP3</b>	System Front Panel Connector	22
<b>PC1</b>	Mini PCI Connector	25
<b>U1</b>	DiskOnChip™ Socket	10

### 3.5 Configuring the CPU

The HS-2608 v2.0 embedded with a ULV Intel® Celeron® processor 400MHz/650MHz. User don't need to adjust the frequently and check speed of Intel® processor.

### 3.6 System Memory

The HS-2608 v2.0 provides one SO-DIMM socket at locations *DM1*. The maximum capacity of the onboard memory is 512MB.

### 3.7 DiskOnChip™ Address Setting

The DiskOnChip™ function allows the system to boot or operate without a FDD or a HDD. DiskOnChip™ modules may be formatted as drive C or A. With DiskOnChip™, user may also execute DOS commands such as FORMAT, SYS, COPY, XCOPY, DISCOPY and DISKCOMP etc.

The U1 location on the HS-2608 v2.0 is the DiskOnChip™ module socket. Jumper *JP4(1-4)* assigns the starting memory address of the installed module. If you have another memory device that has a similar memory capacity with that of the DOC in your system, please set both at different memory address mapping to avoid the mapping area conflicts. Failing to do so will not make the HS-2608 v2.0 and the additional memory device function properly.

- **JP4(1-4): DiskOnChip™ Address Select**

Address	PINS 1-2	PINS 3-4
D000 (default)	Short	Short
D800	Open	Short
E000	Short	Open

#### 3.7.1 Installing DiskOnChip™ Modules

When installing a DiskOnChip™ module onto your board, please take note of the following:

1. Orient yourself properly with the location of the DiskOnChip™ socket. Try to locate the pin 1 location on your socket. Pin numbers are usually printed on either the component side or the solder side of your board.



2. Locate the Pin 1 location on your DiskOnChip™ module. More often than not, Pin 1 can be found on the lower left corner of the chip. Please refer to the diagram for the exact location.
3. Once you have figured out where the pin 1 locations are on both chip and socket, align the module's pins on an upright angle against the socket. Using both thumbs, gently press the module into the socket until all the pins are secured to their designations.

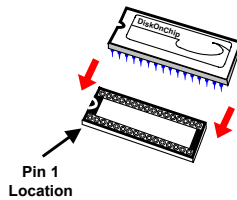

4. The installation is now complete and your module is now ready for use.

**NOTE:** *If you encounter difficulty installing your DiskOnChip™ module, please consult a qualified technician or engineer to perform the installation.*

### 3.7.2 Removing DiskOnChip™ Modules

When removing a DiskOnChip™ module from its socket, please take note of the following:

1. Loosen the contact of the module from its socket using a screwdriver.
2. Insert the screwdriver's flat head into a gap on either end of the socket. Do not insert the screwdriver head on either side where the pins are located. Doing so might damage the pins in the process.
3. Slowly lift the screwdriver handle upwards. This will disengage the module from its socket.

**NOTE:** *If you encounter difficulty removing your DiskOnChip™ module, please consult a qualified technician or engineer to remove it for you.*

### 3.8 VGA Controller

The HS-2608 v2.0 provides three connection methods of a VGA device. CN20 offers a single standard CRT connector while CN21 is the 50-pin panel connector and CN26/CN27 are the LVDS interface connectors onboard reserved for flat panel installation.

- **CN20: CRT Connector**

PIN	Description	PIN	Description
1	Red	2	Green
3	Blue	4	N/C
5	GND	6	GND
7	GND	8	GND
9	N/C	10	GND
11	N/C	12	SDA
13	HSYNC	14	VSYNC
15	SCL		

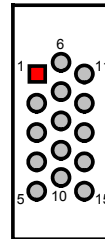

- **CN26/CN27: LVDS Interface Connector**

PIN	Description	PIN	Description
1	V <sub>LCD</sub>	2	V <sub>LCD</sub>
3	Y0M/Z0M	4	Y0P/Z0P
5	Y1M/Z1M	6	Y1P/Z1P
7	Y2M/Z2M	8	Y2P/Z2P
9	Y3M/Z3M	10	Y3P/Z3P
11	GND	12	GND

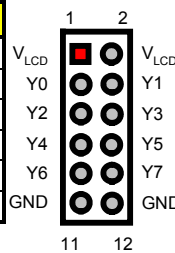

**NOTE:** LVDS cable should be produced very carefully. Y0 & Y1 have to be fabricated in twister pair (Y2 & Y3, Y4 & Y5, Y6 & Y7 and so on) otherwise the signal won't be stable. Please set the proper voltage of your panel using JP7 before proceeding on installing it.

● **CN21: 50-pin Panel Connector**

PIN.	Description	PIN	Description
1	N/C	2	N/C
3	GND	4	GND
5	V <sub>LCD</sub>	6	ENAVDD
7	ENAVEE	8	GND
9	PD0	10	PD1
11	PD2	12	PD3
13	PD4	14	PD5
15	PD6	16	PD7
17	PD8	18	PD9
19	PD10	20	PD11
21	PD12	22	PD13
23	PD14	24	PD15
25	PD16	26	PD17
27	PD18	28	PD19
29	PD20	30	PD21
31	PD22	32	PD23
33	PD24	34	PD25
35	SHFCLK	36	FLM
37	DE	38	LP
39	GND	40	ENABKL
41	P26	42	P27
43	P28	44	P29
45	P30	46	P31
47	P32	48	P33
49	P34	50	P35

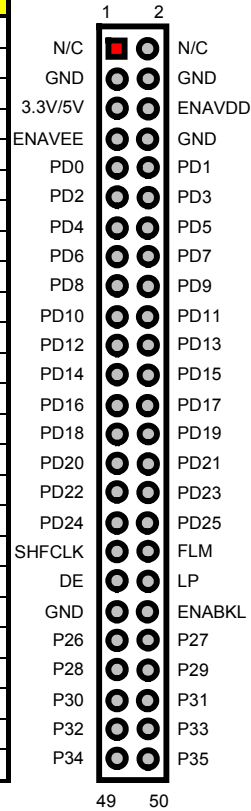

**NOTE:** Please set the proper voltage of your panel using JP7 before proceeding on installing it.

The HS-2608 v2.0 has an onboard jumper that selects the working voltage of the flat panel connected to the system. Jumper JP7 offers two voltage settings for the user.

● **JP7: Panel Voltage Select**

Options	Settings
<b>+3.3V (default)</b>	Short 1-2
<b>+5V</b>	Short 2-3

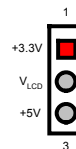

### 3.9 PCI E-IDE Drive Connector

CN23 is a standard 44-pin 2.0mm pitch connector daisy-chain driver connector serves the PCI E-IDE drive provisions onboard the HS-2608 v2.0. A maximum of two ATA/33/66/100 IDE drives can be connected to the HS-2608 v2.0 via CN23.

- **CN23: IDE Connector**

PIN	Description	PIN	Description
1	IDERST	2	GND
3	PDD7	4	PDD8
5	PDD6	6	PDD9
7	PDD5	8	PDD10
9	PDD4	10	PDD11
11	PDD3	12	PDD12
13	PDD2	14	PDD13
15	PDD1	16	PDD14
17	PDD0	18	PDD15
19	GND	20	N/C
21	PDDREQ	22	GND
23	IOW#	24	GND
25	IOR#	26	GND
27	PIORDY	28	470Ω with GND
29	PDDACK#	30	GND
31	IRQ14	32	N/C
33	PDA1	34	PD33/66
35	PDA0	36	PDA2
37	PDCS1#	38	PDCS3#
39	HDD Active	40	GND
41	VCC	42	VCC
43	GND	44	N/C

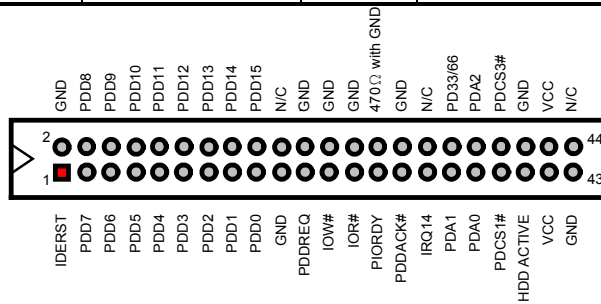

If you want to use ATA/66/100 IDE device, please purchase this cable separately.



Optional Cable	
Part No.	Description
<b>291-04010200G</b>	ATA/66/100 IDE cable for 2.0-pitch IDE connector

### 3.10 Floppy Disk Drive Connector

The HS-2608 v2.0 uses a standard 34-pin header connector, *CN8*, for floppy disk drive connection. A total of two FDD drives may be connected to *CN8* at any given time.

- **CN8: Floppy Connector**

PIN	Description	PIN	Description
<b>1</b>	GND	<b>2</b>	DRV DEN0
<b>3</b>	GND	<b>4</b>	N/C
<b>5</b>	GND	<b>6</b>	DRV DEN1
<b>7</b>	GND	<b>8</b>	INDEX#
<b>9</b>	GND	<b>10</b>	MTR0#
<b>11</b>	GND	<b>12</b>	DS1#
<b>13</b>	GND	<b>14</b>	DS0#
<b>15</b>	GND	<b>16</b>	MTR1#
<b>17</b>	GND	<b>18</b>	DIR#
<b>19</b>	GND	<b>20</b>	STEP#
<b>21</b>	GND	<b>22</b>	WDATA#
<b>23</b>	GND	<b>24</b>	WGATE#
<b>25</b>	GND	<b>26</b>	TRAK00#
<b>27</b>	GND	<b>28</b>	WRTPRT#
<b>29</b>	GND	<b>30</b>	RDATA#
<b>31</b>	GND	<b>32</b>	HDSEL#
<b>33</b>	GND	<b>34</b>	DSKCHG#

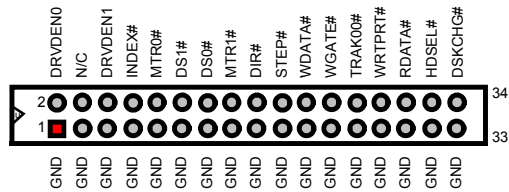

### 3.11 Serial Port Connectors

The HS-2608 v2.0 offers two NS16C550 compatible UARTs with Read/Receive 16-byte FIFO serial ports and four internal 10-pin headers and one RS-422/485 connector.

- CN16: COM1 Connector (5x2 Header)**

PIN	Description	PIN	Description
1	DCD1	2	DSR1
3	RXD1	4	RTS1
5	TXD1	6	CTS1
7	DTR1	8	RI1
9	GND	10	N/C

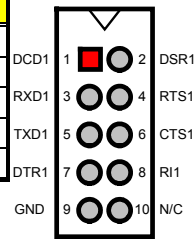

- CN18: COM2 Connector (5x2 Header)**

PIN	Description	PIN	Description
1	DCD2	2	DSR2
3	RXD2	4	RTS2
5	TXD2	6	CTS2
7	DTR2	8	RI2
9	GND	10	N/C

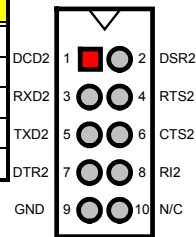

● **CN14: COM3 Connector (5x2 Header)**

PIN	Description	PIN	Description
1	DCD3	2	DSR3
3	RXD3	4	RTS3
5	TXD3	6	CTS3
7	DTR3	8	RI3
9	GND	10	N/C

● **CN19: COM4 Connector (5x2 Header)**

PIN	Description	PIN	Description
1	DCD4	2	DSR4
3	RXD4	4	RTS4
5	TXD4	6	CTS4
7	DTR4	8	RI4
9	GND	10	N/C

● **CN10: RS-422/485 Connector (5x2 Header, COM2)**

PIN	Description	PIN	Description
1	TX-	2	TX+
3	RX+	4	RX-
5	GND	6	RTS-

**NOTE:** The terminal resistance of RX & TX is set at 180 Ω.

● **JP5/JP6: RS-232/422/485 Function Enabled/Disabled Select**

Options	Settings	
	JP5 (7-8)	JP6
<b>RS-232 (default)</b>	Open	Open
<b>RS-485 by Auto</b>	1-2, 3-5, 6-8 Short	Short
<b>RS-485 by -RTS</b>	1-2, 5-7, 6-8 Short	Short
<b>RS-422 Full Duplex</b>	1-2, 4-6 Short	Short

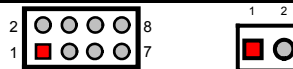

**NOTE:** RS-422/485 port uses COM2. RS-232 of COM2 cannot be used while RS-422/485 is selected.

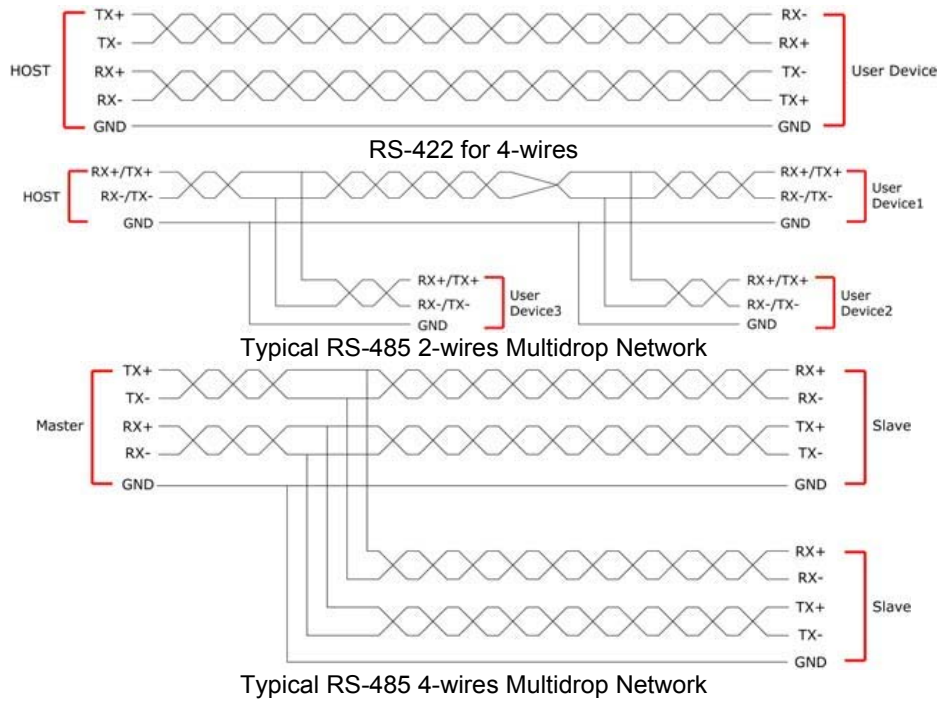



### 3.12 Parallel Connector

CN12 is a standard 26-pin flat cable connector deigned to accommodate parallel port connection on the HS-2608 v2.0.

- **CN12: Parallel Connector**

PIN	Description	PIN	Description
1	Strobe	14	Auto Form Feed
2	DATA 0	15	ERROR#
3	DATA 1	16	Initialize
4	DATA 2	17	Printer Select LN#
5	DATA 3	18	GND
6	DATA 4	19	GND
7	DATA 5	20	GND
8	DATA 6	21	GND
9	DATA 7	22	GND
10	Acknowledge	23	GND
11	Busy	24	GND
12	Paper Empty	25	GND
13	Printer Select	26	GND

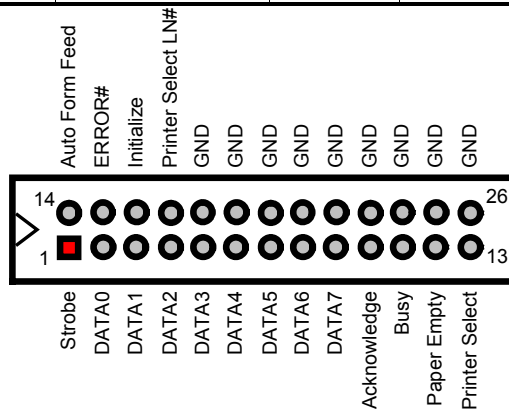

### 3.13 Ethernet Connector

The HS-2608 v2.0 provides two external RJ-45 interface connectors. Please refer to the following for its pin information.

- **CN13/CN28: RJ-45 Connector**

PIN	Description
1	TX+
2	TX-
3	RX+
4	R/C GND
5	R/C GND
6	RX-
7	R/C GND
8	R/C GND

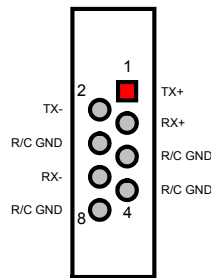

### 3.14 USB Connector

The HS-2608 v2.0 provides one 8-pin connectors, at location *CN1*, for two USB connections to the HS-2608 v2.0.

- **CN1: USB Connector**

PIN	Description	PIN	Description
1	VCC	2	VCC
3	USBD1-	4	USBD0-
5	USBD1+	6	USBD0+
7	GND	8	GND

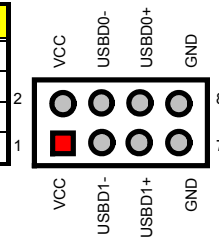

### 3.15 CMOS Data Clear

The HS-2608 v2.0 has a Clear CMOS jumper on JP2.

- **JP2: Clear CMOS**

Options	Settings
Normal Operation (default)	Short 1-2
Clear CMOS	Short 2-3

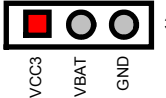

**IMPORTANT:** Before you turn on the power of your system, please set JP2 to Short 1-2 for normal operation.

### 3.16 Power and Fan Connectors

HS-2608 v2.0 provides one 5-pin power connectors at CN2. And one 2-pin power in at CN5.

- **CN2: 5-pin ATX Power In Connector**

PIN	Description	PIN	Description
1	GND	2	PS_ON
3	+12V	4	5VSB
5	VCC		

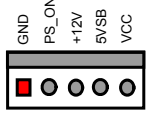

- **CN5: 2-pin Power In Connector**

PIN	Description
1	VCC
2	GND

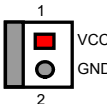

- **FN1: Fan Connector**

PIN	Description
1	CPU Fan1
2	+5V
3	GND

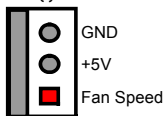

Connector FN1 onboard HS-2608 V2.0 is a 3-pin fan power output connector. And HS-2608 v2.0 supports +5V Fan only.

### 3.17 Keyboard/Mouse Connectors

The HS-2608 v2.0 offers two possibilities for keyboard/mouse connections. The connections are via *CN15* for an external PS/2 type keyboard/mouse or via *CN17* for an internal 6-pin cable converter to a keyboard/mouse.

- **CN15: PS/2 6-pin Mini DIN Keyboard/Mouse Connector**

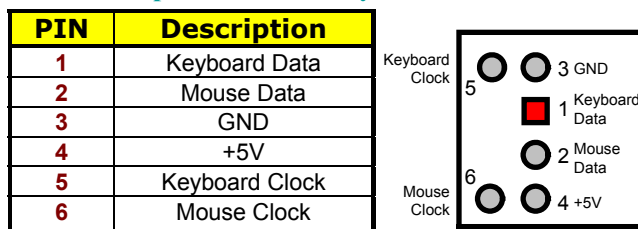

- **CN17: 6-pin Keyboard/Mouse Connector**

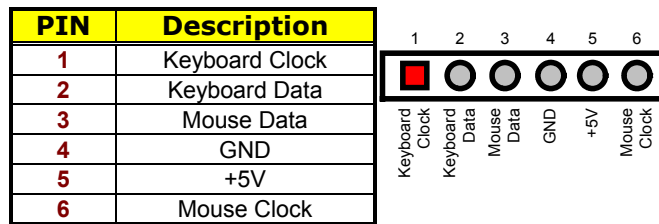

### 3.18 System Front Panel Connectors

The HS-2608 v2.0 has one LED at location *JP3* that indicates the power-on status. This visual feature of the IDE LED may also be connected to an external IDE LED, Speaker, Reset Switch, Power LED, EXT SMI, Power Button, and SLP Button via connector *JP3(13-15)*, *JP3(1-3-5-7)*, *JP3(9-11)*, *JP3(2-4)*, *JP3(6-8)*, *JP3(10-12)*, *JP3(14-16)*.

- **JP3: System Front Panel Connector**

PIN	Description	PIN	Description
1	330Ω Pull +5V	2	330Ω Pull +5V
3	GND	4	GND
5	+5V	6	EXT SMI
7	Speaker	8	GND
9	GND	10	PW Button
11	Reset Switch	12	GND
13	330Ω Pull +5V	14	SLP Button
15	HDD LED	16	GND

**Connector JP3 Orientation**

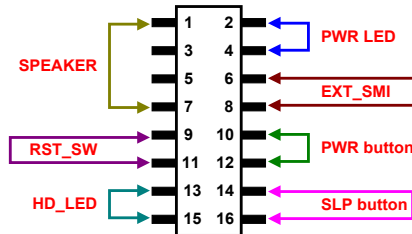

- **CN25: External Reset Button**

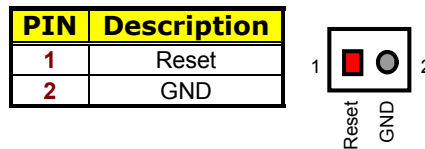

### 3.19 Watchdog Timer

There are three access cycles of Watch-Dog Timer as Enable, Refresh and Disable. The Enable cycle proceeds via READ PORT 443H whereas the Disable cycle proceeds via READ PORT 045H. A continued Enable cycle after a first Enable cycle means Refresh.

Once the Enable cycle is active, a Refresh cycle is requested before the time-out period. This restarts counting of the WDT period. When the time counting goes over the preset period of WDT, it will assume that the program operation is abnormal. A System Reset signal to re-start or a NMI cycle to the CPU transpires when such error happens. Jumper *JP1* is used to select the function of Watchdog Timer.

● **JP1: Watchdog Timer Active Type Setting**

Options	Settings
Active NMI	Short 1-2
System Reset	Short 2-3
Disabled WDT (default)	Open



● **JP4(5-10): WDT Timeout Period Select**

Period	PINS 5-6	PINS 7-8	PINS 9-10
1 sec (default)	Short	Short	Short
2 sec	Open	Short	Short
10 sec	Short	Open	Short
20 sec	Open	Open	Short
110 sec	Short	Short	Open
220 sec	Open	Short	Open

The Watchdog Timer is disabled after the system Power-On. It can be enabled via an Enable cycle and reading the control port (443H), or via a Refresh cycle and reading the control port (443H), or via a Disable cycle and reading the disable control port (045H).

After an Enable cycle of WDT, user must immediately execute a Refresh cycle to WDT before its period setting comes to an end every 1, 2, 10, 20, 110 or 220 seconds. If the Refresh cycle does not activate before WDT period cycle, the onboard WDT architecture will issue a Reset or NMI cycle to the system. There are three I/O ports that control the Watchdog Timer.

<b>443H</b>	I/O Read	The Enable cycle
<b>443H</b>	I/O Read	The Refresh cycle
<b>045H</b>	I/O Read	The Disable cycle

The following sample program shows how to Enable, Disable and Refresh the Watchdog Timer:

```

WDT_EN_RF    EQU    0443H
WDT_DIS      EQU    0045H

WT_Enable    PUSH    AX                ; keep AX DX
              PUSH    DX
              MOV     DX,WDT_EN_RF    ; enable the WDT
              IN     AL,DX
              POP     DX                ; get back AX, DX
              POP     AX
    
```

```

RET
WT_Refresh  PUSH  AX          ; keep AX, DX
            PUSH  DX
            MOV   DX,WDT_ET_RF ; refresh the WDT
            IN   AL,DX
            POP  DX          ; get back AX, DX
            POP  AX
            RET
WT_DISABLE  PUSH  AX
            PUSH  DX
            MOV   DX,WDT_DIS   ; disable the WDT
            IN   AL,DX
            POP  DX          ; get back AX, DX
            POP  AX
            RET

```

## 3.20 Mini PCI Connector

HS-2608 v2.0 supports a Mini PCI connector at *PC1*. The peripheral component with standard Type1 Mini PCI can be used. For particular requirement, please refer to “BOSER Mini PCI series product” on website or contact with us.

### 3.21 PC/104 Connectors

The PC/104 expansion bus offers provisions to connect all types of PC/104 modules. With the PC/104 bus being known as the new generation of industrial embedded 16-bit PC standard bus, thousands of PC/104 modules from multiple vendors can be easily installed onboard. The detailed pin assignment of the PC/104 expansion bus connectors CN3 and CN4 are listed on the following tables:

**NOTE :** *The PC/104 connector allows direct plugging or stack-through piling of PC/104 modules without requiring the PC/104 mounting kit.*

● **CN3: PC/104 40-pin Connector**

PIN	Description	PIN	Description
1	GND	21	GND
2	-MEMCS16	22	-SBHE
3	-IOSC16	23	SA23
4	IRQ10	24	SA22
5	IRQ11	25	SA21
6	IRQ12	26	SA20
7	IRQ15	27	SA19
8	IRQ14	28	SA18
9	-DACK0	29	SA17
10	DRQ0	30	-MEMR
11	-DACK5	31	-MEMW
12	DRQ5	32	SD8
13	-DACK6	33	SD9
14	DRQ6	34	SD10
15	-DACK7	35	SD11
16	DRQ7	36	SD12
17	+5V	37	SD13
18	-MASTER	38	SD14
19	GND	39	SD15
20	GND	40	N/C

Connector diagram rotated 90 degrees clockwise from original position

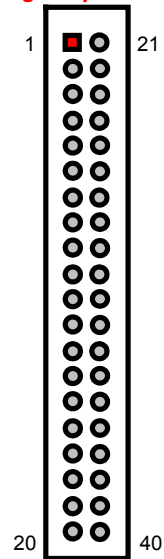



● CN4: PC/104 64-pin Connector

PIN	Description	PIN	Description
1	-IOCHECK	33	GND
2	SD7	34	RESETDRV
3	SD6	35	+5V
4	SD5	36	IRQ9
5	SD4	37	N/C
6	SD3	38	N/C
7	SD2	39	N/C
8	SD1	40	N/C
9	SD0	41	N/C
10	IOCHRDY	42	GND
11	AEN	43	-SMEMW
12	SA19	44	-SMEMR
13	SA18	45	-IOW
14	SA17	46	-IOR
15	SA16	47	-DACK3
16	SA15	48	DRQ3
17	SA14	49	-DACK1
18	SA13	50	DRQ1
19	SA12	51	-REFRESH
20	SA11	52	SYSCLK
21	SA10	53	IRQ7
22	SA9	54	IRQ6
23	SA8	55	IRQ5
24	SA7	56	IRQ4
25	SA6	57	IRQ3
26	SA5	58	-DACK2
27	SA4	59	TC
28	SA3	60	BALE
29	SA2	61	+5V
30	SA1	62	OSC
31	SA0	63	N/C
32	GND	64	GND

Connector diagram rotated 90 degrees clockwise from original position

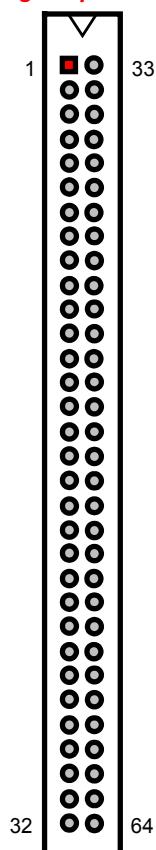

## 3.22 Audio Connectors

The HS-2608 v2.0 has an onboard AC97 3D audio interface. The following tables list the pin assignments of the Line In/Audio Out connector.

- **CN9: Line In/Audio Out Connector**

PIN	Description	PIN	Description
1	AOUTL	2	AOUTR
3	GND	4	GND
5	MIC IN	6	LIR
7	GND	8	LIL

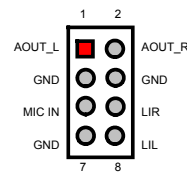

## 3.23 CompactFlash™ Connector

The HS-2608 v2.0 also offers an optional CompactFlash™ connector which is IDE interface located at the solder side of the board (beneath the SO-DIMM connector). The designated *CN24* connector, once soldered with an adapter, can hold CompactFlash™ cards of various sizes. Please turn off the power before inserting the CD card.

- **CN24: CompactFlash™ Connector**

PIN	Description	PIN	Description
1	GND	2	DATA 3
3	DATA 4	4	DATA 5
5	DATA 6	6	DATA 7
7	SDCS1#	8	GND
9	GND	10	GND
11	GND	12	GND
13	VCC (+5V)	14	GND
15	GND	16	GND
17	GND	18	SDA2
19	SDA1	20	SDA0
21	DATA 0	22	DATA 1
23	DATA 2	24	470Ω pull to GND
25	N/C	26	N/C
27	DATA 11	28	DATA 12
29	DATA 13	30	DATA 14
31	DATA 15	32	SDCS3#

... More on next page ...

PIN	Description	PIN	Description
33	N/C	34	IOR
35	IOW	36	EWE0
37	IRQ	38	VCC (+5V)
39	CS	40	N/C
41	Reset	42	IORDY
43	N/C	44	REQ 0
45	IDE LED	46	PDIAG
47	DATA 8	48	DATA 9
49	DATA 10	50	GND

Inserting a CompactFlash™ card into the adapter is not a difficult task. The socket and card are both keyed and there is only one direction for the card to be completely inserted. Refer to the diagram on the following page for the traditional way of inserting the card.

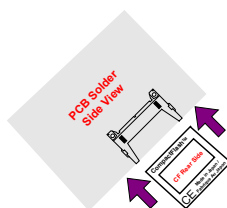

## 3.24 8-bit I/O Function

The HS-2608 v2.0 offers one 8-bit input/output port by parallel port.

- **CN6: 8-bit Input/Output**

PIN	Description	PIN	Description
1	VCC	2	GND
3	GD0	4	GD4
5	GD1	6	GD5
7	GD2	8	GD6
9	GD3	10	GD7



.286

```

.MODEL SMALL
.DATA
port equ 0378h ;this is data area
;print port can be change to 278h

.CODE

print macro buff
mov dx, offset buff;
mov ah,09h
int 21h

```

```

        endm

delay :
        push    cx
        mov     cx,0155h
@@:
        jmp     $+2
        push    cx
        mov     cx,0ffffh

wait1:  loop    wait1
        pop     cx
        loop   @b
        pop     cx
        ret

begin   proc    near
        mov     ax,@data
        mov     ds,ax

        Mov     dx, port
        Mov     al, 80h           out     dx, al

;;-----
;;ROR
        mov     cx, 08h
@@:
        ror     al, 1
        call   delay
        out     dx, al
        loop   @b
        pop     cx

;;ROL
        push    cx
        mov     cx, 08h
@@:
        rol     al, 1
        out     dx, al
        call   delay
        loop   @b
        pop     cx

;;-----
;;ROR
        mov     cx, 08h
@@:
        ror     al, 1
        call   delay
        out     dx, al
        loop   @b
        pop     cx

;;ROL
        push    cx
        mov     cx, 08h
@@:
        rol     al, 1
        out     dx, al
        call   delay
        loop   @b
        pop     cx

```

```

;;-----
;;-----
;;ROR
    mov     cx, 08h
@@:
    ror     al, 1
    call   delay
    out    dx, al
    loop   @b
    pop    cx
;;ROL
    push   cx
    mov    cx, 08h
@@:
    rol    al, 1
    out    dx, al
    call   delay
    loop   @b
    pop    cx
;;-----
;;-----
;;ROR
    mov     cx, 08h
@@:
    ror     al, 1
    call   delay
    out    dx, al
    loop   @b
    pop    cx
;;ROL
    push   cx
    mov    cx, 08h
@@:
    rol    al, 1
    out    dx, al
    call   delay
    loop   @b
    pop    cx
;;-----
;;-----
;;ROR
    mov     cx, 08h
@@:
    ror     al, 1
    call   delay
    out    dx, al
    loop   @b
    pop    cx
;;ROL
    push   cx
    mov    cx, 08h
@@:
    rol    al, 1
    out    dx, al
    call   delay
    loop   @b
    pop    cx
;;-----
;;-----
;;ROR
    mov     cx, 08h
@@:

```

```

        ror     al, 1
        call delay
        out    dx, al
        loop   @b
        pop    cx
;;ROL
        push   cx
        mov    cx, 08h
@@:
        rol    al, 1
        out    dx, al
        call delay
        loop   @b
        pop    cx
;;-----
;;
;;ROR
        mov    cx, 08h
@@:
        ror    al, 1
        call delay
        out    dx, al
        loop   @b
        pop    cx
;;ROL
        push   cx
        mov    cx, 08h
@@:
        rol    al, 1
        out    dx, al
        call delay
        loop   @b
        pop    cx
;;-----
;flash LED 3 time
        mov    cx, 01h
@@:
        mov    al, 0ffh
        out    dx, al
        call delay
        mov    al, 0h
        out    dx, al
        call delay
        loop   @b
ee:
        mov    ah, 4ch
        int    21h
        .stack
        begin  endp
                                ;go back to dos

                                end begin

```

# Chapter 4

---

## AMI BIOS Setup

The HS-2608 v2.0 uses AMI BIOS for the system configuration. The AMI BIOS setup program is designed to provide the maximum flexibility in configuring the system by offering various options that could be selected for end-user requirements. This chapter is written to assist you in the proper usage of these features.

### 4.1 Starting Setup

The AMI BIOS is immediately activated when you first power on the computer. The BIOS reads the system information contained in the CMOS and begins the process of checking out the system and configuring it. When it finishes, the BIOS will seek an operating system on one of the disks and then launch and turn control over to the operating system.

While the BIOS is in control, the Setup program can be activated in one of two ways:

1. By pressing <Del> immediately after switching the system on, or
2. By pressing the <Del> key when the following message appears briefly at the bottom of the screen during the POST (Power On Self Test).





**Press DEL to enter SETUP.**

If the message disappears before you respond and you still wish to enter Setup, restart the system to try again by turning it OFF then ON or pressing the "RESET" button on the system case. You may also restart by simultaneously pressing <Ctrl>, <Alt>, and <Delete> keys. If you do not press the keys at the correct time and the system does not boot, an error message will be displayed and you will be asked to...

**PRESS F1 TO CONTINUE, DEL TO ENTER SETUP**

## 4.2 Using Setup

In general, you use the arrow keys to highlight items, press <Enter> to select, use the <PageUp> and <PageDown> keys to change entries, and press <Esc> to quit. The following table provides more detail about how to navigate in the Setup program using the keyboard.

	Move to previous item
	Move to next item
	Move to previous item
	Move to previous item
<b>Esc key</b>	Main Menu -- Quit and not save changes into CMOS Status Page Setup Menu and Option Page Setup Menu -- Exit current page and return to Main Menu
<b>PgUp key</b>	Decrease the numeric value or make changes
<b>PgDn key</b>	Increase the numeric value or make changes
<b>+ key</b>	Increase the numeric value or make changes
<b>- key</b>	Decrease the numeric value or make changes
<b>F1 key</b>	Reserved
<b>F2 key</b>	Change color from total 8 colors. F2 to select color forward
<b>F3 key</b>	F2 to select color backward
<b>F4 key</b>	Reserved
<b>F5 key</b>	Reserved
<b>F6 key</b>	Reserved
<b>F7 key</b>	Reserved
<b>F8 key</b>	Reserved
<b>F9 key</b>	Reserved
<b>F10 key</b>	Save all the CMOS changes, only for Main Menu



## 4.3 Main Menu

Once you enter the AMI BIOS CMOS Setup Utility, the Main Menu will appear on the screen. The Main Menu allows you to select from several setup functions and two exit choices. Use the arrow keys to select among the items and press <Enter> to enter the sub-menu.

<b>AMIBIOS HIFLEX SETUP UTILITY – VERSION x.xx (C)2001 American Megatrends, Inc. All Rights Reserved</b>
Standard CMOS Setup Advanced CMOS Setup Advanced Chipset Setup Power Management Setup PCI / Plug and Play Setup Peripheral Setup Hardware Monitor Setup Auto-Detect Hard Disks Change User Password Change Supervisor Password Auto Configuration with Optimal Settings Auto Configuration with Fail Safe Settings Save Settings and Exit Exit Without Saving
Standard CMOS setup for changing time, date, hard disk type, etc. ESC:Exit ↑↓:Sel F2/F3: Color F10: Save & Exit

**NOTE:** *A brief description of the highlighted choice appears at the bottom of the screen.*

## 4.4 Standard CMOS Setup

The Standard Setup is used for the basic hardware system configuration. The main function is for Data/Time and Floppy/Hard Disk Drive settings. Please refer to the following screen for the setup. When the capacity of the IDE hard disk drive is larger than 528MB, you must set the HDD mode to **LBA** mode. Please use the IDE Setup Utility in BIOS SETUP to install the HDD correctly.

<b>AMIBIOS SETUP – STANDARD CMOS SETUP</b>										
<b>(C)2001 American Megatrends, Inc. All Rights Reserved</b>										
Date (mm/dd/yyyy) : Thu Apr 17, 2003					Base Memory :		639KB			
Time (hh/mm/ss) : 19:04:12					Extd Memory :		55MB			
Floppy Drive A: 1.44MB, 3 1/2										
Floppy Drive B: Not Installed										
							LBA	Blk	PIO	32Bit
	Type	Size	Cyln	Head	WPcom	Sec	Mode	Mode	Mode	Mode
Pri Master	:	Auto								ON
Pri Slave	:	Auto								ON
Sec Master	:	Auto								ON
Sec Slave	:	Auto								ON
Virus Protection : Disabled										
Language Setting : English										
Month:	Jan - Dec					ESC: Exit		↑↓: Sel		
Day:	01 - 31					PgUp/PgDn: Modify				
Year:	1980 - 2099					F2/F3: Color				

## 4.5 Advanced CMOS Setup

This section allows you to configure your system for the basic operation. You have the opportunity to select the system's default speed, boot-up sequence, keyboard operation, shadowing and security.

<b>AMIBIOS SETUP – ADVANCED CMOS SETUP</b> <b>(C)2001 American Megatrends, Inc. All Rights Reserved</b>		
Quick Boot	Enabled	▲ Available Options:
Pri Master ARMD Emulated as	Auto	▶ Disabled
Pri Slave ARMD Emulated as	Auto	Enabled
Sec Master ARMD Emulated as	Auto	
Sec Slave ARMD Emulated as	Auto	
USB ARMD Emulated as	Auto	
1st Boot Device	Floppy	
2nd Boot Device	IDE-0	
3rd Boot Device	CD-ROM	
Try Other Boot Devices	Yes	
Init Display Mode	Silent	
Display Mode at Add-on ROM Init	Force BIOS	
S.M.A.R.T. for Hard Disks	Disabled	
BootUp Num-Lock	On	
Floppy Drive Swap	Disabled	
Floppy Drive Seek	Disabled	
PS/2 Mouse Support	Enabled	
Primary Display	VGA/EGA	
Password Check	Setup	
Boot To OS/2	No	
Wait For 'F1' If Error	Enabled	
CPU MicroCode Updation	Enabled	
CPU Serial Number	Enabled	
L1 Cache	Enabled	
L2 Cache	Enabled	
System BIOS Cacheable	Enabled	
C000,32k Shadow	Cache	
C800,16k Shadow	Disabled	
CC00,16k Shadow	Disabled	
D000,16k Shadow	Disabled	
D400,16k Shadow	Disabled	
D800,16k Shadow	Disabled	
DC00,16k Shadow	Disabled	
		ESC: Exit    ↑↓: Sel
		PgUp/PgDn: Modify
		▼ F2/F3: Color

## 4.6 Advanced Chipset Setup

This section allows you to configure the system based on the specific features of the installed chipset. This chipset manages bus speeds and the access to the system memory resources, such as DRAM and the external cache. It also coordinates the communications between the conventional ISA and PCI buses. It must be stated that these items should never be altered. The default settings have been chosen because they provide the best operating conditions for your system. You might consider and make any changes only if you discover that the data has been lost while using your system.

<b>AMIBIOS SETUP – ADVANCED CHIPSET SETUP (C)2001 American Megatrends, Inc. All Rights Reserved</b>		
***** DRAM Timing *****		Available Options:
Configure SDRAM Timing by SPD	Disabled	▶ Disabled
DRAM Frequency	100Mhz	Enabled
SDRAM CAS# Latency	3	
DRAM Bank Interleave	Enabled	
Memory Hole	Disabled	
AGP Mode	4x	
AGP Fast Write	Disabled	
AGP Comp. Driving	Auto	
Manual AGP Comp. Driving	CB	
AGP Aperture Size	64MB	
AGP Master 1 W/S Write	Disabled	
AGP Master 1 W/S Read	Disabled	
Search for MDA Resources	Yes	
PCI Delay Transaction	Enabled	
ISA Bus Clock	PCI CLK/4	
USB Controller	All USB Port	
USB Device Legacy Support	Disabled	ESC: Exit    ↑↓: Sel
Port 64/60 Emulation	Disabled	PgUp/PgDn: Modify
ATX Power Supply	Disabled	F2/F3: Color

## 4.7 Power Management Setup

The Power Management Setup allows user to configure the system for saving energy in a most effective way while operating in a manner consistent with his own style of computer use.

<b>AMIBIOS SETUP – POWER MANAGEMENT SETUP</b> <b>(C)2001 American Megatrends, Inc. All Rights Reserved</b>		
ACPI Aware O/S	No	▲ Available Options:
ACPI Standby State	S1/POS	▶ No
Power Management / APM	Enabled	Yes
Video Power Down Mode	Disabled	
Hard Disk Power Down Mode	Disabled	
Standby Time Out (Minute)	Disabled	
Suspend Time Out (Minute)	Disabled	
Throttle Slow Clock Ratio	50%~56.25%	
Display Activity	Ignore	
IRQ3	Monitor	
IRQ4	Monitor	
IRQ5	Ignore	
IRQ7	Monitor	
IRQ9	Ignore	
IRQ10	Ignore	
IRQ11	Ignore	
IRQ12	Ignore	
IRQ13	Ignore	
IRQ14	Monitor	
IRQ15	Ignore	
System Thermal	Disabled	
Thermal Active Temperature	65°C / 149°F	
Thermal Slow Clock Ratio	50%~56.25%	
Power Button Function	On / Off	
Restore on AC / Power Loss	Last State	
Resume On Ring	Disabled	
Resume On LAN	Disabled	
Resume On PME#	Disabled	
Resume On KBC	Disabled	
Wake-Up Key	N/A	
Wake-Up Password	N/A	
Resume On PS/2 Mouse	Disabled	
Resume On RTC Alarm	Disabled	
RTC Alarm Date	15	
RTC Alarm Hour	12	ESC: Exit    ↑↓: Sel
RTC Alarm Minute	30	PgUp/PgDn: Modify
RTC Alarm Second	30	▼ F2/F3: Color

## 4.8 PCI / Plug and Play Setup

This section describes configuring the PCI bus system. PCI, or Personal Computer Interconnect, is a system that allows I/O devices to operate at speeds nearing the speed the CPU itself uses when communicating with its own special components. This section covers some very technical items and it is strongly recommended that only experienced users should make any changes to the default settings.

<b>AMIBIOS SETUP – PCI / PLUG AND PLAY SETUP</b> <b>(C)2001 American Megatrends, Inc. All Rights Reserved</b>		
Plug and Play Aware O/S	No	Available Options:
Clear NVRAM	No	▶ No
OnChip VGA Frame Buffer Size	8MB	Yes
PCI Latency Timer (PCI Clocks)	32	
Primary Graphics Adapter	PCI	
Boot Screen Select	Both CRT & LCD	
LCD Panel Type	0 640 x 480 TFT	
PCI IDE Bus Master	Enabled	
OffBoard PCI IDE Card	Auto	
OffBoard PCI IDE Primary IRQ	Disabled	
OffBoard PCI IDE Secondary IRQ	Disabled	
DMA Channel 0	PnP	
DMA Channel 1	PnP	
DMA Channel 3	PnP	
DMA Channel 5	PnP	
DMA Channel 6	PnP	
DMA Channel 7	PnP	
IRQ3	PCI/PnP	
IRQ4	PCI/PnP	
IRQ5	PCI/PnP	
IRQ7	PCI/PnP	
IRQ9	PCI/PnP	
IRQ10	PCI/PnP	
IRQ11	PCI/PnP	ESC: Exit    ↑↓: Sel
IRQ14	PCI/PnP	PgUp/PgDn: Modify
IRQ15	PCI/PnP	F2/F3: Color

## 4.9 Peripheral Setup

The IDE hard drive controllers can support up to two separate hard drives. These drives have a master/slave relationship that is determined by the cabling configuration used to attach them to the controller. Your system supports two IDE controllers--a primary and a secondary--so you can install up to four separate hard disks.

PIO means Programmed Input/Output. Rather than having the BIOS issue a series of commands to affect the transfer to or from the disk drive, PIO allows the BIOS to tell the controller what it wants and then let the controller and the CPU perform the complete task by them. This is much simpler and more efficient (also faster).

<b>AMIBIOS SETUP – PERIPHERAL SETUP</b> <b>(C)2001 American Megatrends, Inc. All Rights Reserved</b>		
OnBoard FDC	Enabled	Available Options:
OnBoard Serial Port 1	3F8/COM1	▶ Auto
OnBoard Serial Port 2	2F8/COM2	Disabled
Serial Port2 Mode	Normal	Enabled
Duplex Mode	N/A	
OnBoard Parallel Port	378	
Parallel Port Mode	ECP	
EPP Version	N/A	
Parallel Port DMA Channel	3	
Parallel Port IRQ	7	
EPP Version		
OnBoard Serial Port3	3E8/COM3	
Serial Port3 IRQ	10	
OnBoard Serial Port4	2E8/COM4	
Serial Port4 IRQ	11	
OnBoard IDE	Both	
OnBoard AC'97 Audio	Enabled	
OnBoard Legacy Audio	Enabled	
Sound Blaster	Disabled	
SB I/O Base Address	220h-22Fh	
SB IRQ Select	5	
SB DMA Select	1	ESC: Exit ↑↓: Sel
MPU-401	Disabled	PgUp/PgDn: Modify
MPU-401 I/O Address	330h-333h	F2/F3: Color

## 4.10 Hardware Monitor Setup

<b>AMIBIOS SETUP – HARDWARE MONITOR SETUP</b> <b>(C)2001 American Megatrends, Inc. All Rights Reserved</b>	
*** System Hardware Monitor *** CPU Temperature System Temperature CPU Fan Speed Vcore + 2.500V + 3.300V + 5.000V	Available Options: ▶ Disabled Enabled Reset  ESC: Exit    ↑↓: Sel PgUp/PgDn: Modify F2/F3: Color

## 4.11 Auto-Detect Hard Disks

This option detects the parameters of an IDE hard disk drive, and automatically enters them into the Standard CMOS Setup screen.

Up to four IDE drives can be detected, with parameters for each appearing in sequence inside a box. To accept the displayed entries, press the “Y” key; to skip to the next drive, press the “N” key. If you accept the values, the parameters will appear listed beside the drive letter on the screen.

<b>AMIBIOS HIFLEX SETUP UTILITY – VERSION x.xx</b> <b>(C)2001 American Megatrends, Inc. All Rights Reserved</b>
Standard CMOS Setup Advanced CMOS Setup Advanced Chipset Setup Power Management Setup PCI / Plug and Play Setup Peripheral Setup Hardware Monitor Setup <u>Auto-Detect Hard Disks</u> Change User Password Change Supervisor Password Auto Configuration with Optimal Settings Auto Configuration with Fail Safe Settings Save Settings and Exit Exit Without Saving
Auto-detect all hard disk parameters ESC: Exit    ↑↓: Sel    F2/F3: Color    F10: Save & Exit



## 4.12 Change Supervisor/User Password

<b>AMIBIOS HIFLEX SETUP UTILITY – VERSION x.xx</b> <b>(C)2001 American Megatrends, Inc. All Rights Reserved</b>
Standard CMOS Setup Advanced CMOS Setup Advanced Chipset Setup Power Management Setup
<b>Enter new supervisor password: _</b>
Change Supervisor Password Auto Configuration with Optimal Settings Auto Configuration with Fail Safe Settings Save Settings and Exit Exit Without Saving
Change the Supervisor Password ESC: Exit ↑↓:Sel F2/F3: Color F10: Save & Exit

You can set either supervisor or user password, or both of them. The differences are:

- **supervisor password:** can enter and change the options of the setup menus.
- **user password:** just can only enter but do not have the right to change the options of the setup menus.

When you select this function, the following message will appear at the center of the screen to assist you in creating a password.

### ENTER PASSWORD:

Type the password, up to eight characters in length, and press <Enter>. The password typed now will clear any previously entered password from CMOS memory. You will be asked to confirm the password. Type the password again and press <Enter>. You may also press <Esc> to abort the selection and not enter a password.

To disable a password, just press <Enter> when you are prompted to enter the password. A message will confirm the password will be disabled. Once the password is disabled, the system will boot and you can enter Setup freely.

## PASSWORD DISABLED.

When a password has been enabled, you will be prompted to enter it every time you try to enter Setup. This prevents an unauthorized person from changing any part of your system configuration.

Additionally, when a password is enabled, you can also require the BIOS to request a password every time your system is rebooted. This would prevent unauthorized use of your computer.

You determine when the password is required within the BIOS Features Setup Menu and its Security option (see Section 3). If the Security option is set to "System", the password will be required both at boot and at entry to Setup. If set to "Setup", prompting only occurs when trying to enter Setup.

### 4.13 Auto Configuration with Optimal Settings

When you press <Enter> on this item you will get a confirmation dialog box with a message shown below. This option allows you to load/restore the BIOS default values permanently stored in the BIOS ROM. Pressing 'Y' loads the BIOS default values for the most stable.

<p><b>AMIBIOS HIFLEX SETUP UTILITY – VERSION x.xx</b> <b>(C)2001 American Megatrends, Inc. All Rights Reserved</b></p>
<p>Standard CMOS Setup Advanced CMOS Setup Advanced Chipset Setup Power Management Setup</p>
<p><b>Load high performance settings (Y/N) ? <u>N</u></b></p>
<p>Change Supervisor Password Auto Configuration with Optimal Settings Auto Configuration with Fail Safe Settings Save Settings and Exit Exit Without Saving</p>
<p>Load configuration settings giving highest performance ESC:Exit ↑↓:Sel F2/F3: Color F10: Save &amp; Exit</p>

## 4.14 Auto Configuration with Fail Safe Settings

When you press <Enter> on this item you get a confirmation dialog box with a message similar to the figure below. This option allows you to load/restore the default values to your system configuration, optimizing and enabling all high performance features. Pressing 'Y' loads the default values that are factory settings for optimal performance system operations.

<b>AMIBIOS HIFLEX SETUP UTILITY – VERSION x.xx (C)2001 American Megatrends, Inc. All Rights Reserved</b>
Standard CMOS Setup Advanced CMOS Setup Advanced Chipset Setup Power Management Setup
<b>Load failsafe settings (Y/N) ? <u>N</u></b>
Change Supervisor Password Auto Configuration with Optimal Settings Auto Configuration with Fail Safe Settings Save Settings and Exit Exit Without Saving
Load failsafe configuration settings ESC:Exit ↑↓:Sel F2/F3: Color F10: Save & Exit

## 4.15 Save Settings and Exit

Pressing <Enter> on this item asks for confirmation:

<p><b>AMIBIOS HIFLEX SETUP UTILITY – VERSION x.xx</b> <b>(C)2001 American Megatrends, Inc. All Rights Reserved</b></p>
<p>Standard CMOS Setup Advanced CMOS Setup Advanced Chipset Setup Power Management Setup</p>
<p><b>Save current settings and exit (Y/N) ? <u>Y</u></b></p>
<p>Change Supervisor Password Auto Configuration with Optimal Settings Auto Configuration with Fail Safe Settings Save Settings and Exit Exit Without Saving</p>
<p>Write the current setting to CMOS and exit ESC:Exit ↑↓:Sel F2/F3: Color F10: Save &amp; Exit</p>

Pressing “Y” stores the selections made in the menus in CMOS – a special section of memory that stays on after you turn your system off. The next time you boot your computer, the BIOS configures your system according to the Setup selections stored in CMOS. After saving the values the system will be restarted again.

## 4.16 Exit Without Saving

Pressing <Enter> on this item asks for confirmation:

**Quit without saving (Y/N)? Y**

This allows you to exit Setup without storing in CMOS any change. The previous selections remain in effect. This exits the Setup utility and restarts your computer.

<b>AMIBIOS HIFLEX SETUP UTILITY – VERSION x.xx (C)2001 American Megatrends, Inc. All Rights Reserved</b>
Standard CMOS Setup Advanced CMOS Setup Advanced Chipset Setup Power Management Setup
<b>Quit without saving (Y/N) ? <u>N</u></b>
Change Supervisor Password Auto Configuration with Optimal Settings Auto Configuration with Fail Safe Settings Save Settings and Exit Exit Without Saving
Exit without saving the current setting ESC:Exit ↑↓:Sel F2/F3: Color F10: Save & Exit
Abandon all Data & Exit Setup

**This page is intentionally left blank.**

# Chapter 5

## Software Utilities

This chapter contains the detailed information of IDE, VGA and LAN driver installation procedures.

### 5.1 IDE Driver Installation

The utility disk that came with the delivery package contains an auto-run program that invokes the installation programs for the IDE, VGA and Audio drivers. The following describes the installation procedures of each driver.

1. Insert Utility CD Disk to your CD ROM. The main menu will pop up as shown below.

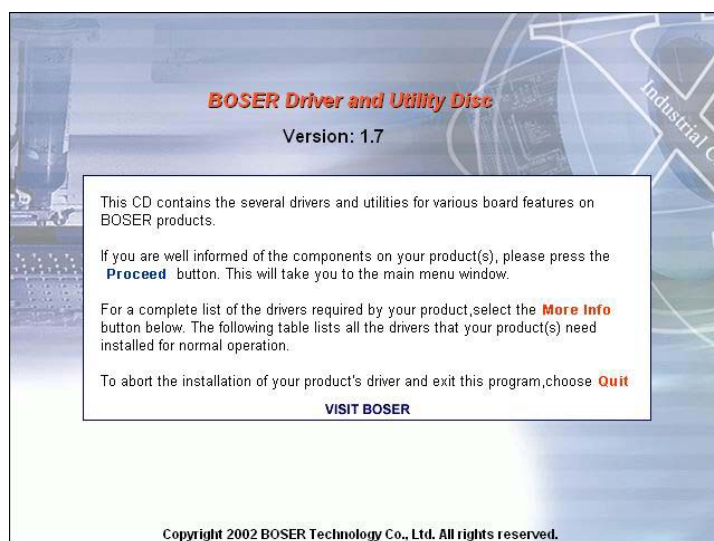

2. Press "VIA 4 IN 1" and to go Setup.

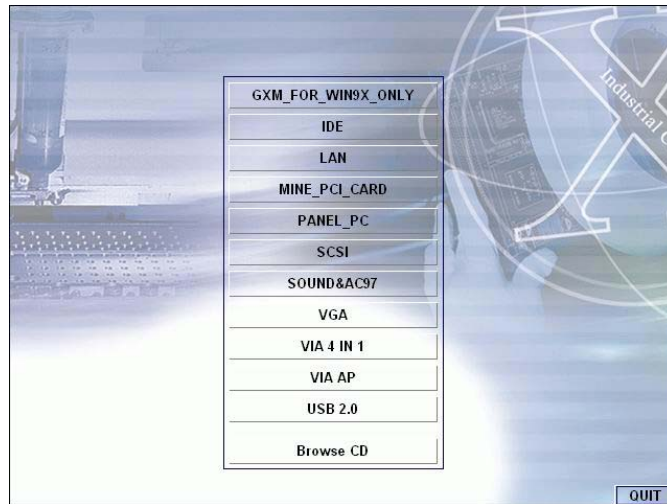

3. Once the Welcome screen appears on the screen, make sure to close any applications running and then click on the Next button.

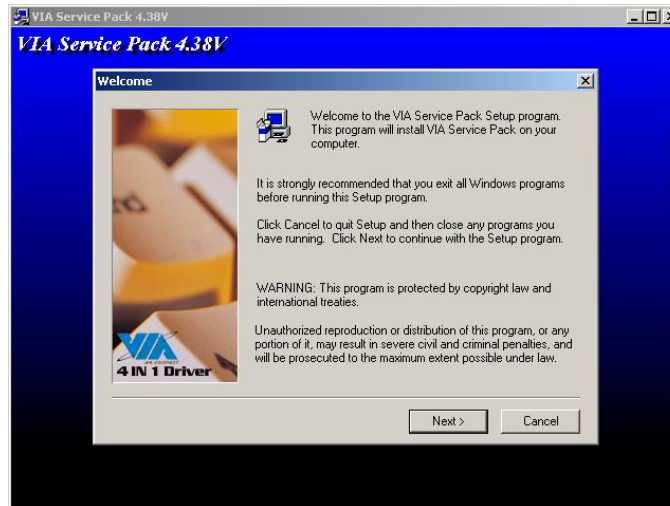



4. When the Readme window pops on the screen, you may read the whole document including the license agreement or just press Yes to skip through and continue installation.

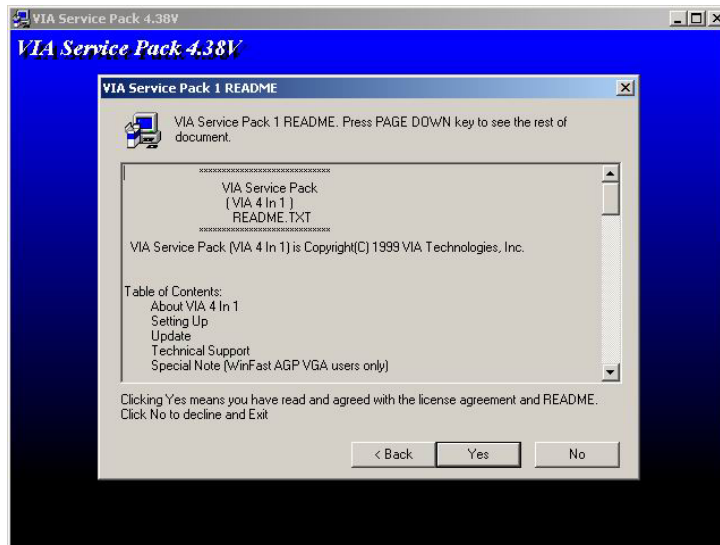

5. The 4 in 1 Setup dialog is now displayed. Select on Normally Install and then click on Next.

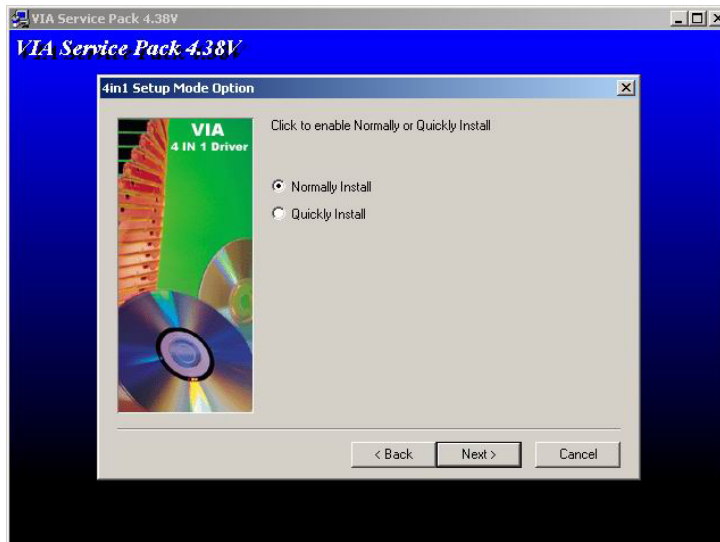

- The next window lists all components detected in your system and asks you to select the ones requiring drivers. Tick on all items then proceed by clicking on the Next button below the screen.

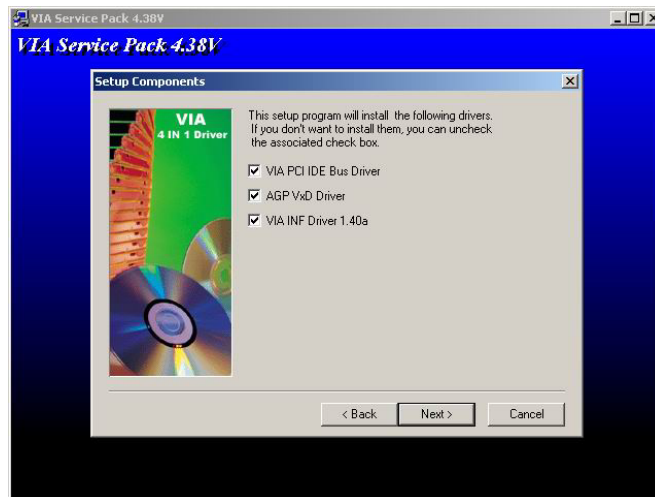

- The program starts to install the ATAPI driver when you click the Next button on the screen below.

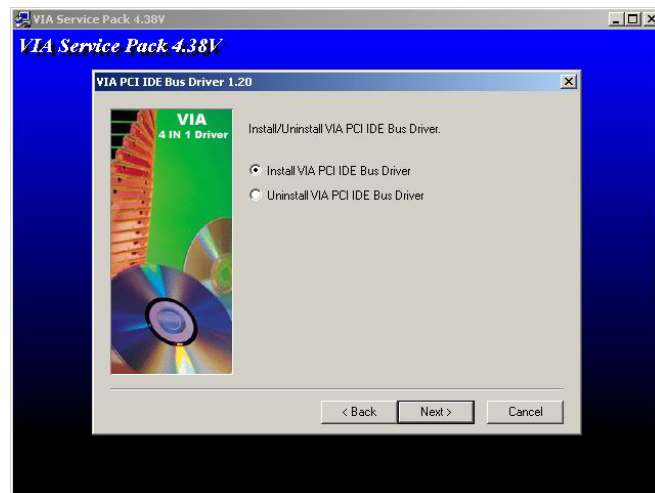

- When the ATAPI driver is completely installed. The utility then displays your DMA mode status and allows you to enable it. Tick on the box and press on the Next button to continue.

9. The following screen then gives you the choice of installing the AGP driver in standard or turbo mode. Select on the Standard Mode and then click on Next to proceed.

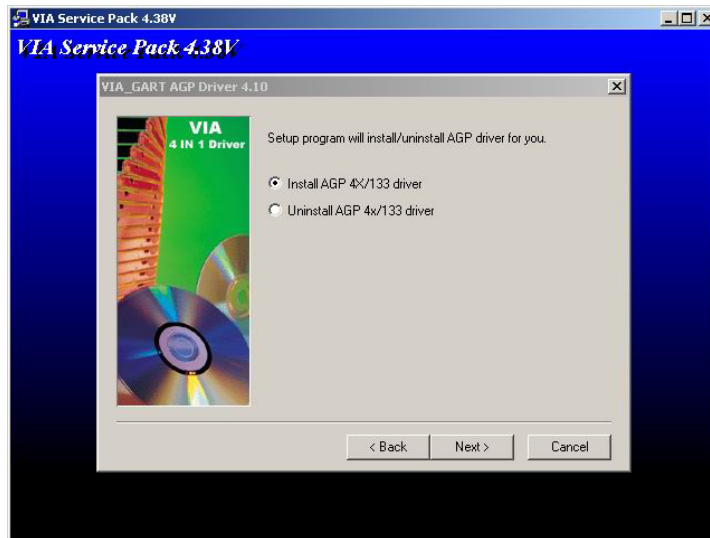

10. Installation of the AGP driver is now complete. Once the screen below appears, select on restarting your computer to activate all drivers/settings completed.

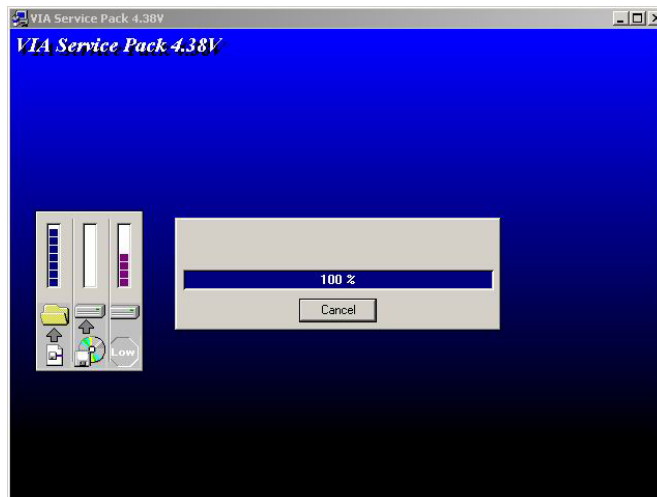

## 5.2 VGA Driver Installation

### 5.2.1 VGA Driver Installation for WIN95/98/2K

1. With the Utility CD Disk still in your CD ROM drive, open the File Manager and then select the CD-ROM drive. As soon as the system reads the disk, the VGA Menu screen below will appear on your display. Click on VIA\_8606 from the main menu.

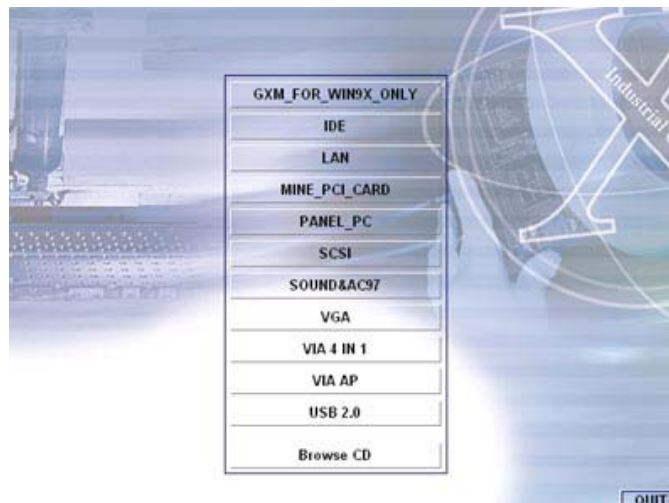
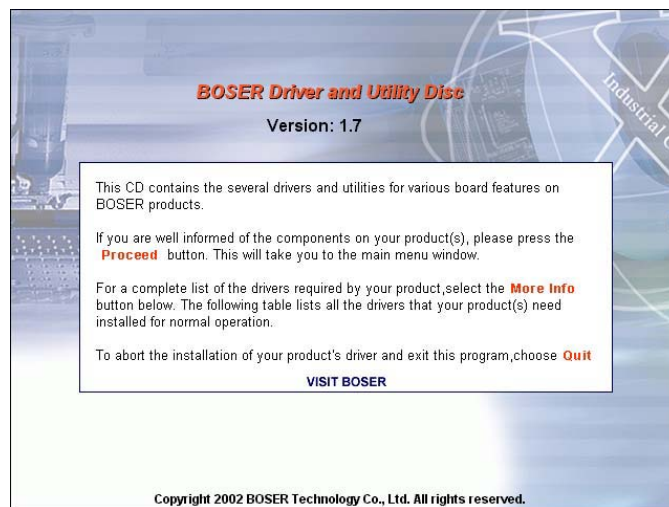



2. Select the operating system of your computer to proceed with the installation process.

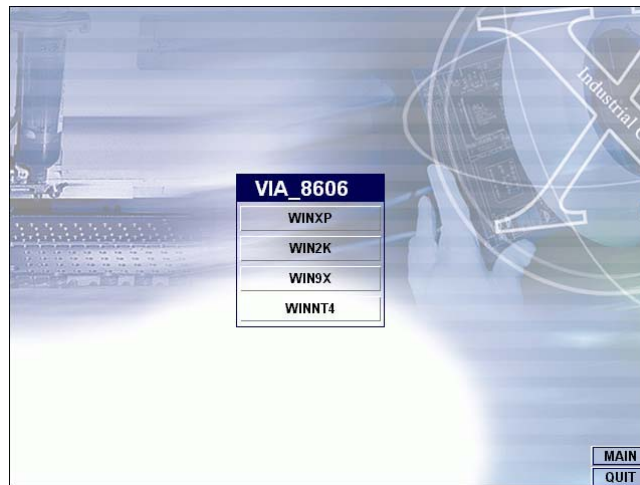

3. Once the Welcome screen appears on the screen, make sure to close applications that are running and then click the Next button.



4. When the display below appears on your screen, Setup is already ready to install and copy the related files onto your hard drive. Click on the Next button to proceed.

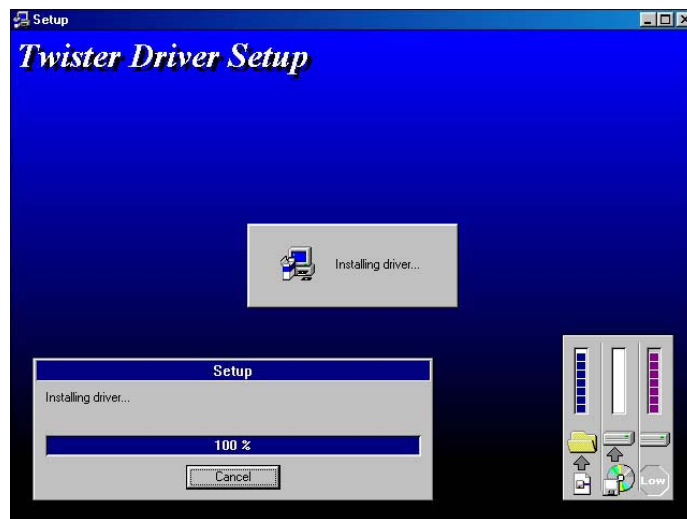

5. After the installation finishes, you will be prompted to restart your system. We recommend you to reboot your computer to allow the new settings to take effect. Click on the Finish button to reboot.

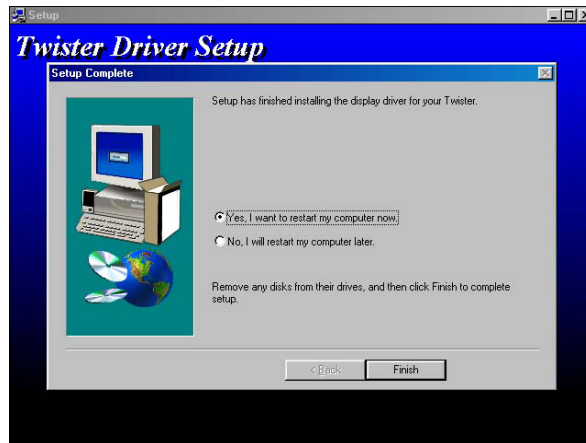

### 5.2.2 VGA Driver Installation for WIN NT4.0

1. Click the **Start** button on the lower left hand corner of your screen, then select **Setting**. Choose **Control Panel** and double-click on the **Display** icon to launch its **Display Properties** window. Click on the **Settings** tab, and then choose **Display Type**. In the **Change Display Type** window, click on **Have Disk**.

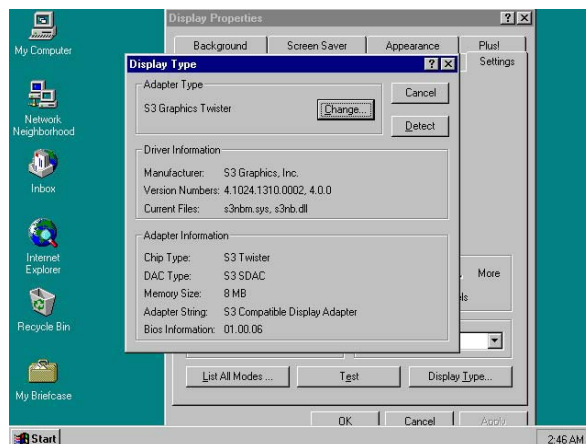

- Specify the path of the new driver and then press on **Enter**. (If in driver D:, type d:\Vga/Via\_8606/Nt40)

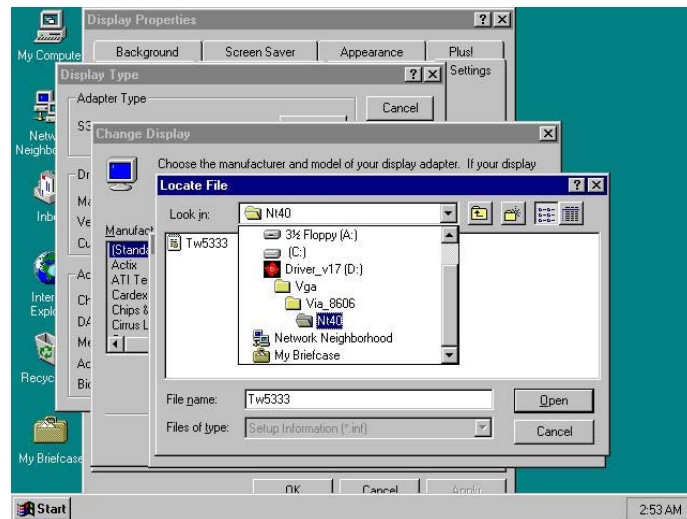

- Select

**S3 Graphics Twister**

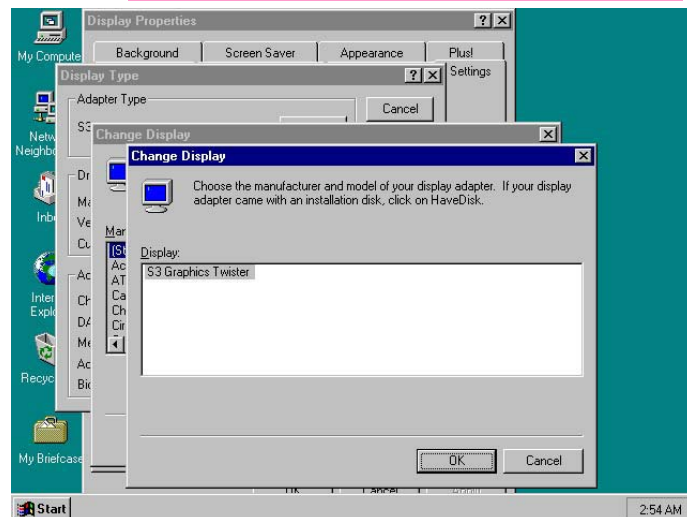

- Click **OK** or press **Enter**.



7. You will see warning panel about **Third Party Drivers**. Click on **Yes** to finish the installation.

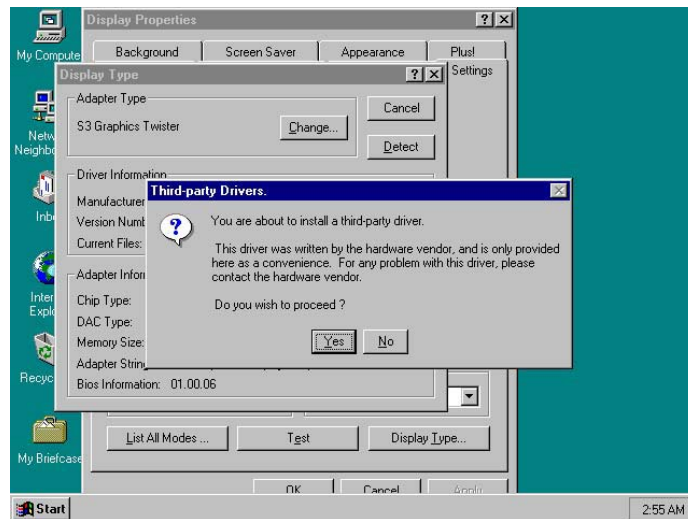

8. Once the installation is completed, you must shut down the system and restart for the new driver to take effect.

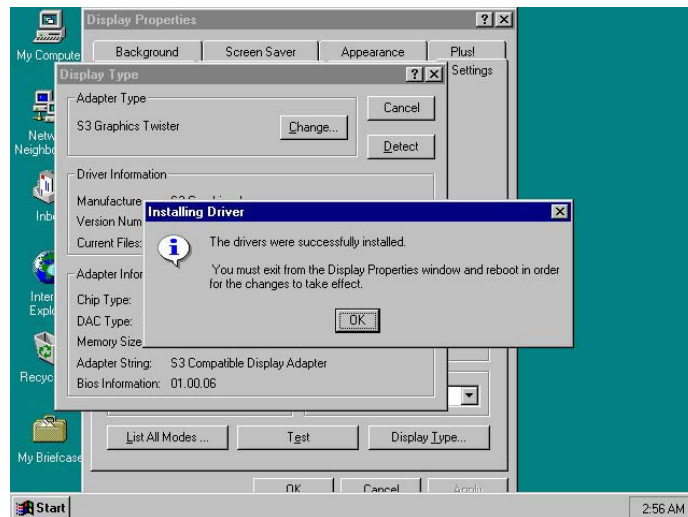

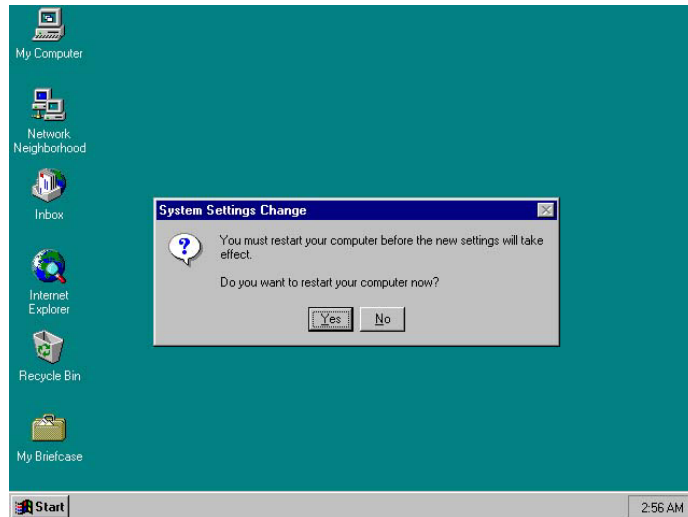

## 5.3 LAN Driver Installation

### 5.3.1 LAN Driver Installation for WIN95/98/2K

1. With the Utility CD Disk still in your CD ROM drive, right click on My Computer icon from the Windows menu. Select on System Properties and then proceed to the Device Manager from the main menu.



2. Select on Other Devices from the list of devices then double-click on PCI Ethernet Controller.

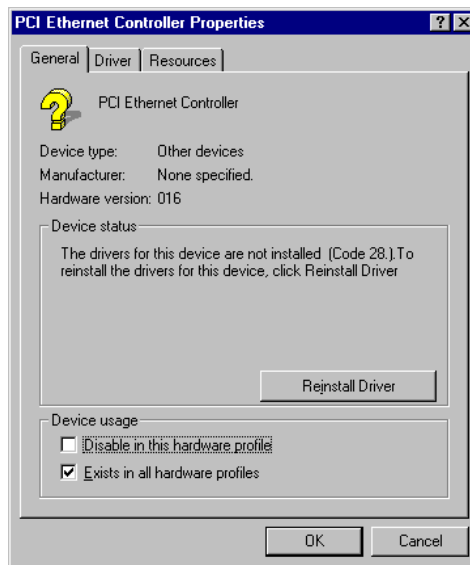
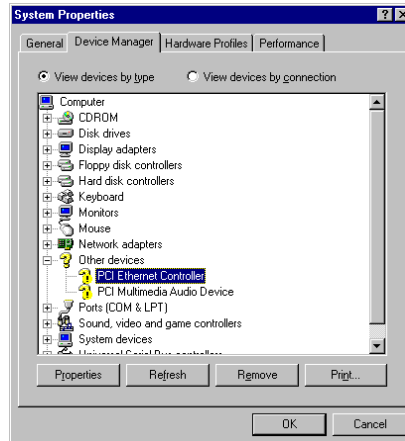

3. The PCI Ethernet Controller Properties screen then appears, allowing you to re-install the driver. Select Driver from the main menu to proceed.

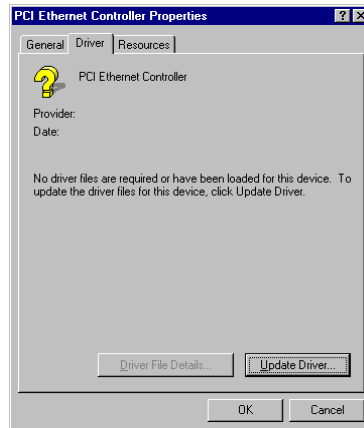

4. The window then displays the current status of your LAN driver. Press on Update Driver button to continue.
5. The program will then launch the Update Device Driver Wizard window that will install your device driver. Click on the Next button to proceed to the next step.



6. When the succeeding window asks you what you wish Windows to do, tick on the "Search for a better driver..." Click on the Next button to proceed.



7. The Update Device Driver Wizard will then ask you to specify, by ticking, the path of the new driver. Tick on the open boxes where you require the program to search for the device driver then click on the Browse button to manually specify the path.



8. Press on the OK button as soon as you have located the path of your driver.

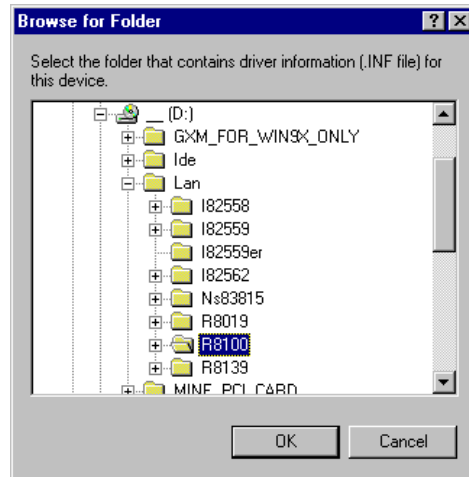

9. Once the program returns to the Add New Hardware Wizard screen, your specified location will appear. Press on the Next button to continue.



10. Once the program detects the device driver (\*.inf) file from your specified location, it will automatically copy the files into your hard drive.

11. When copying of driver files finishes, the program will then ask you to insert your Windows.



12. The program then copies the necessary files from your Windows installation disk to complete the driver setup process. Once the driver is completely installed, the following message appears on your display. Click on the Finish button to proceed.

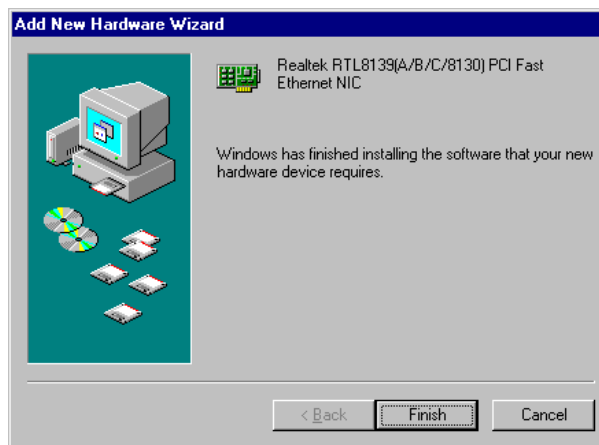

13. Restart your computer to make the new system settings take effect. Click on the Yes button when the screen below appears and your LAN Driver for Win95 and Win98 are now completely installed.



### 5.3.2 LAN Driver Installation for WIN NT4.0

1. With the Utility CD Disk still in your CD ROM drive, right click on Network Neighborhood icon from the Windows menu. Select on Properties.

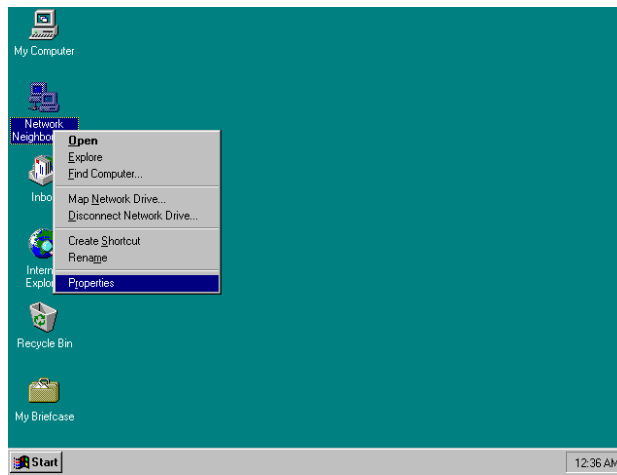

2. The system automatically detects the absence of Windows NT Networking. Click on the Yes button to start installation.

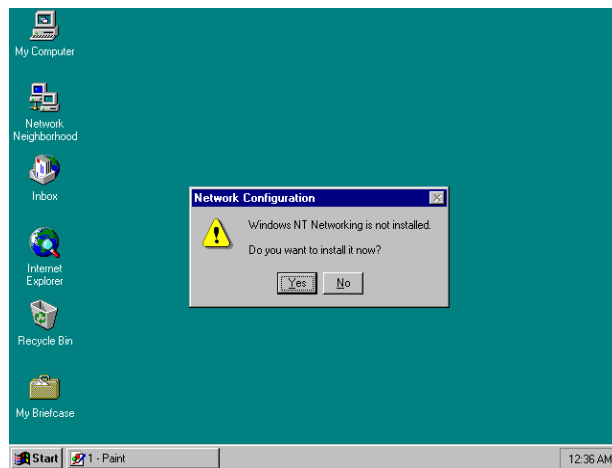



3. Tick on the "Wired to Network" once the following screen appears. Click on the Next to proceed.

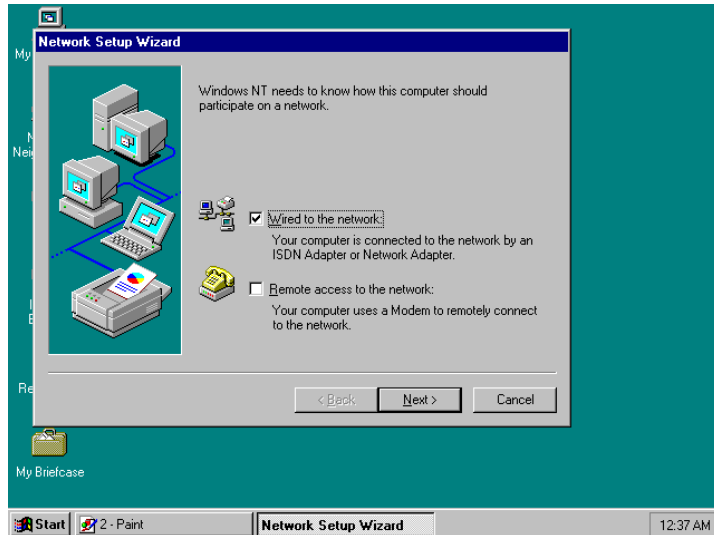

4. Click on the Start Search button for the program to locate the Network Adapter.

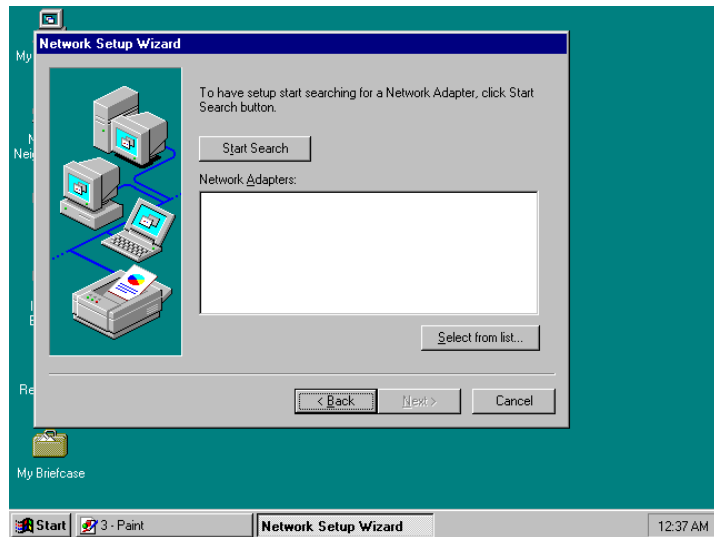

- Once setup finishes the search, it will list a number of adapters for you to choose from. Press on the Have Disk button to assign the driver path location.

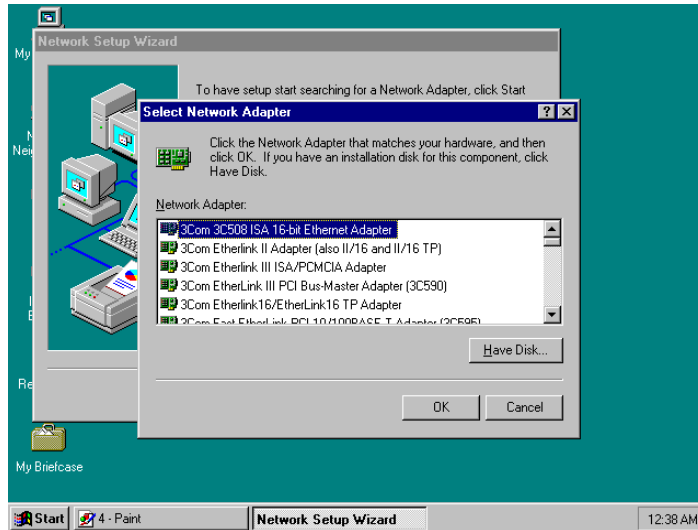

- Setup now asks you for the location of the driver. When you have entered the new driver path, press on the OK button to continue.

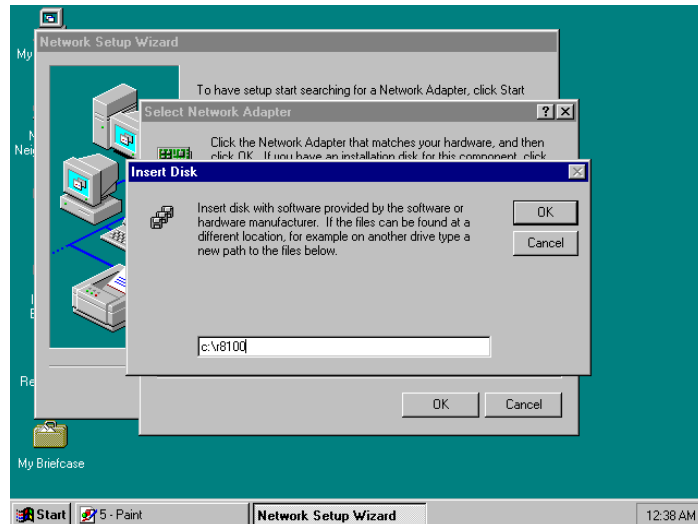

- When Setup finds the information it needs about the new driver, it will display the device it found on the following screen. Press on the OK button to accept and proceed.

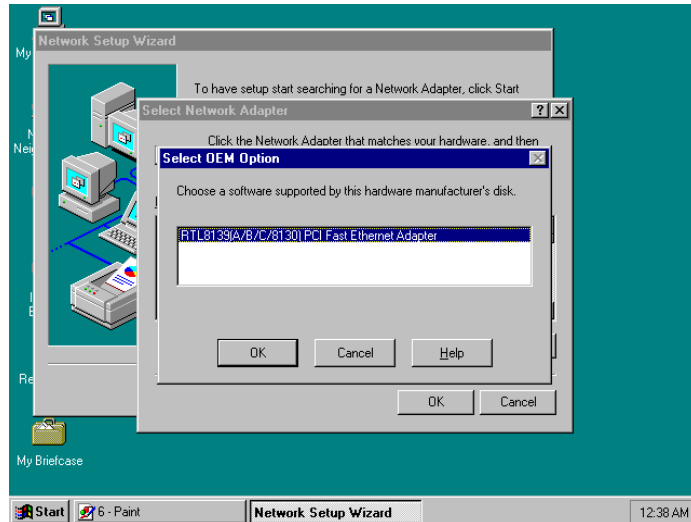

- Setup then returns to Network Setup Wizard screen and displays your new Network Adapter. Click on Next to continue.

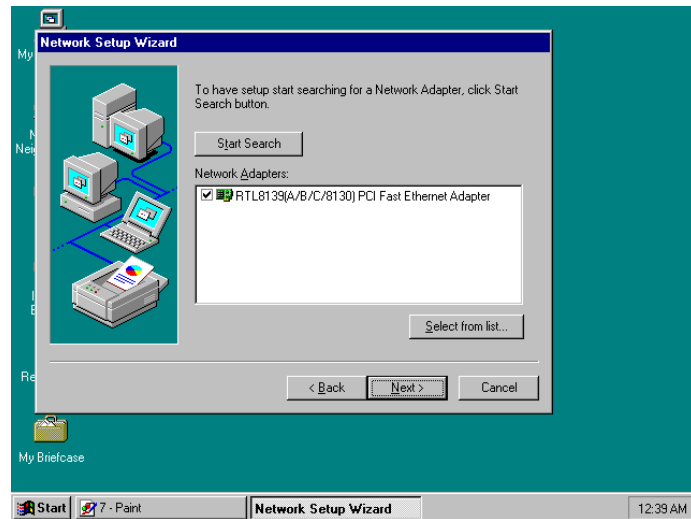

9. The Network Setup Wizard then allows you to set the Network Protocols on your network. Select the appropriate protocol and then click on Next to continue.

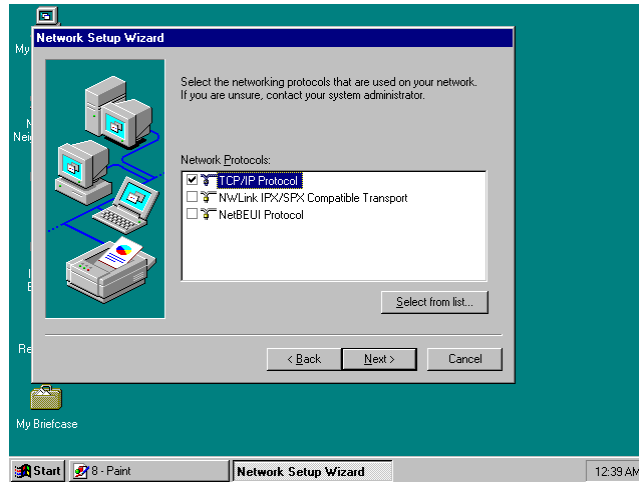

10. Before Setup starts installing the components found and the settings you made, it will give you the option to proceed or go back for changes from the following screen. Click on the Next button once you are sure of your devices.

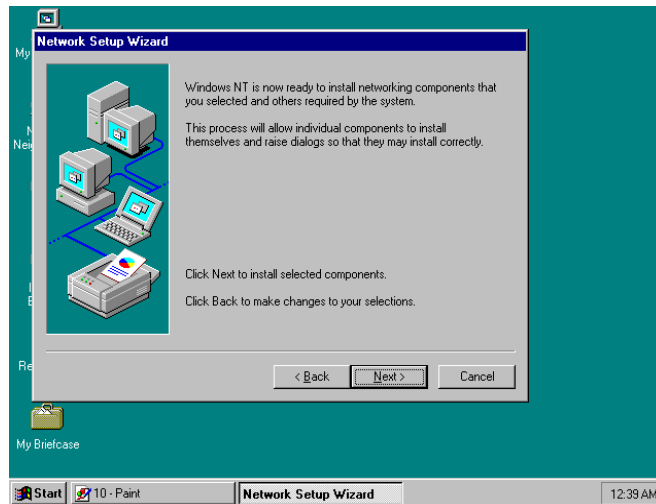

11. Windows NT Setup will then need to copy files necessary to update the system information. Specify the path then press Continue.

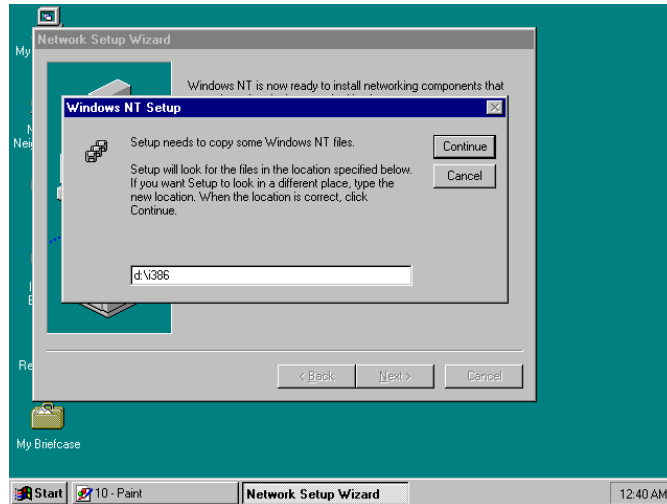

12. Once it finishes copying the files, Setup will now allow you to choose the Duplex Mode of your LAN controller. Press on the Continue button after making your selection.

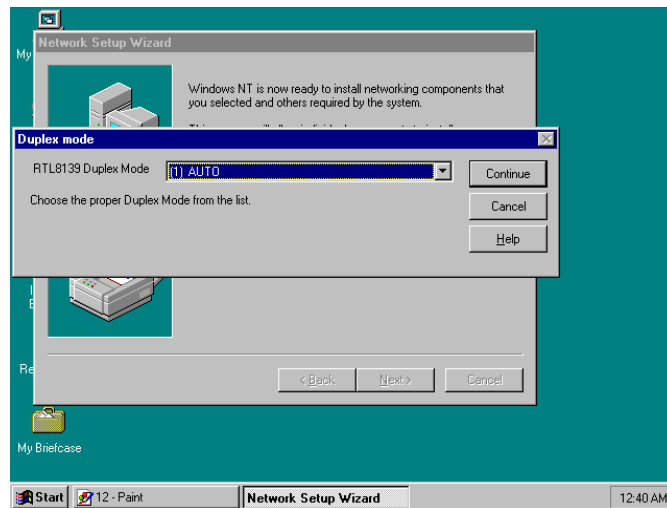

13. When Setup asks if you wish to change the TCP/IP settings of your system, select the appropriately. The default choice is No.

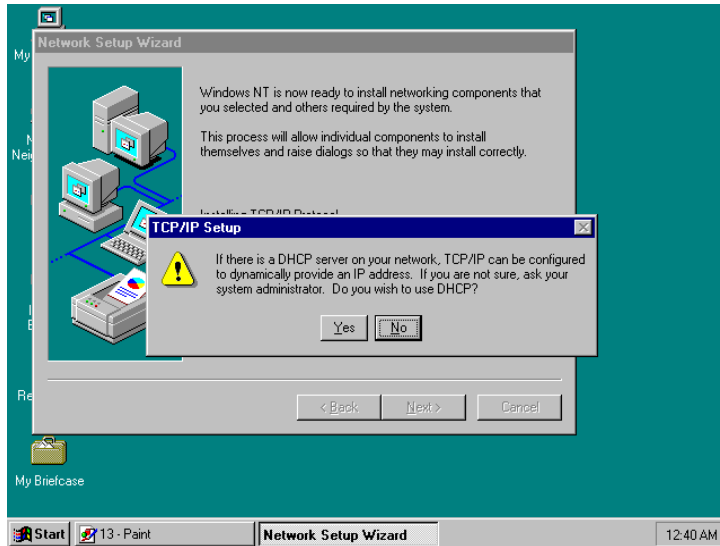

14. Setup then starts the Networking installation and copies the files.

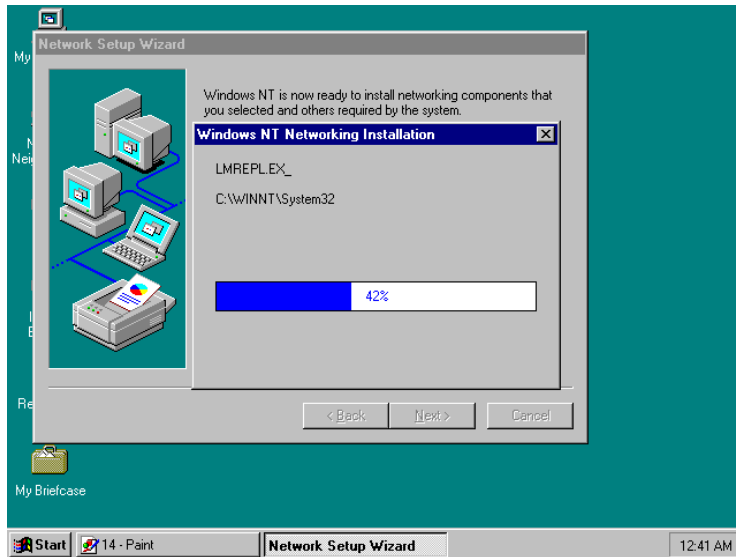

15. When Setup finishes copying, the TCP/IP properties of your system will then pop up on your screen like the one shown below. Make the necessary changes then click on OK to continue.

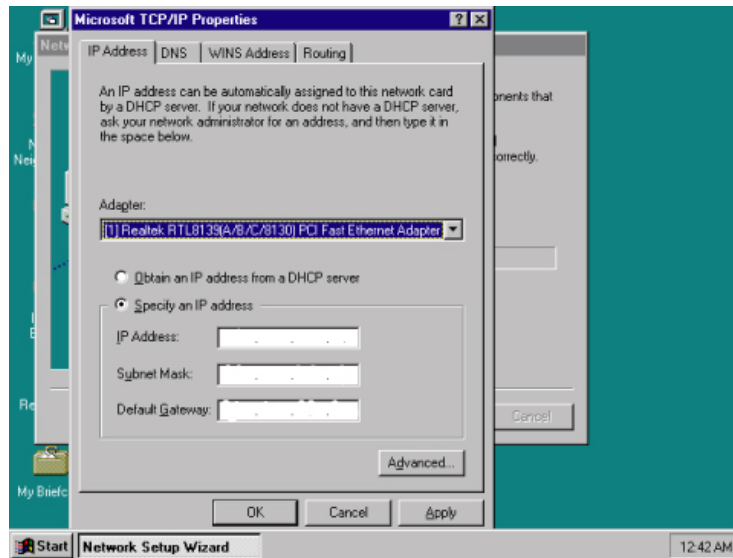

16. When the screen below appears, click on Next to continue.

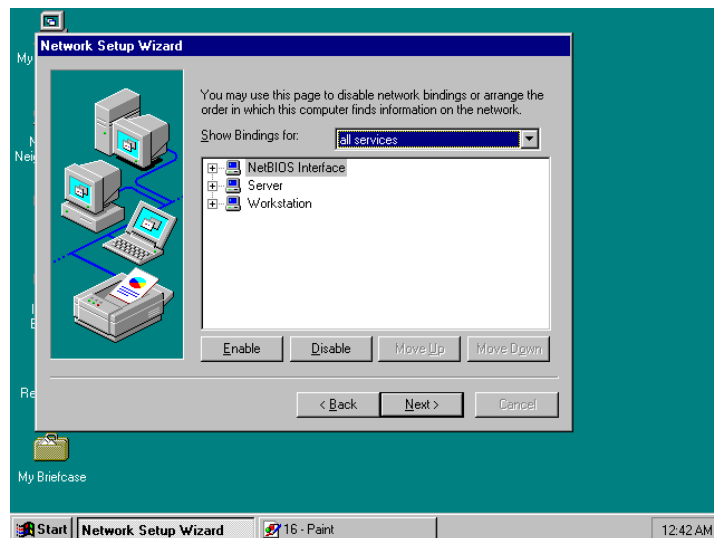

17. Setup then prompts you that it is ready to start the network. You may complete the installation thereafter. Click on Next to continue.

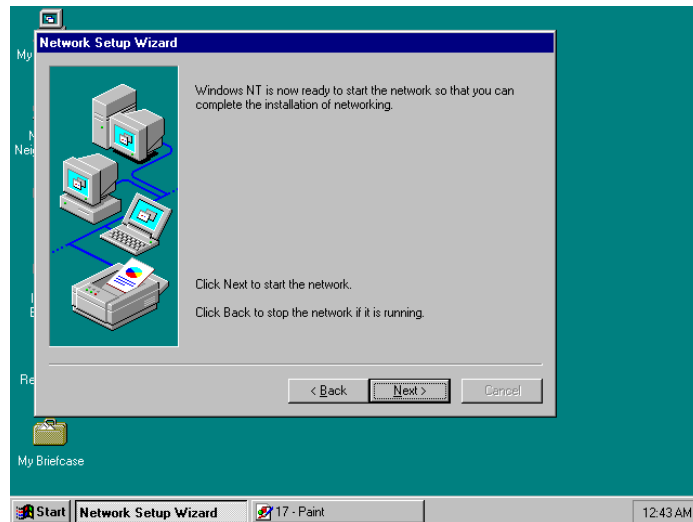

18. Assign the workgroup or domain setting of your computer. Click on Next to continue.

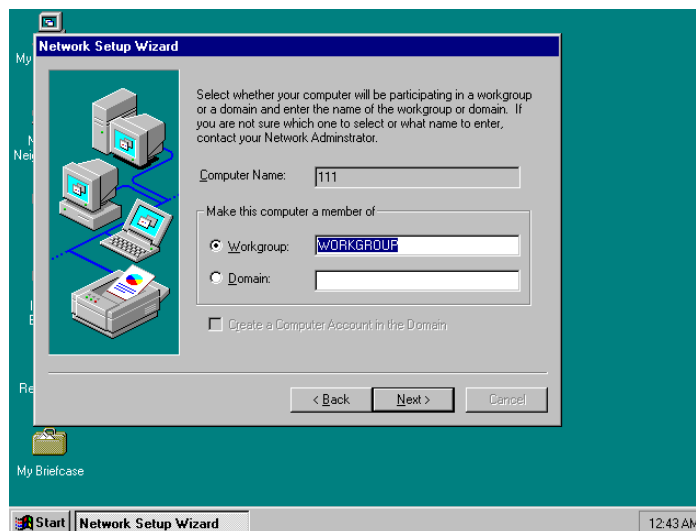



19. Restart your computer once the screen below appears. Click on Finish to continue.

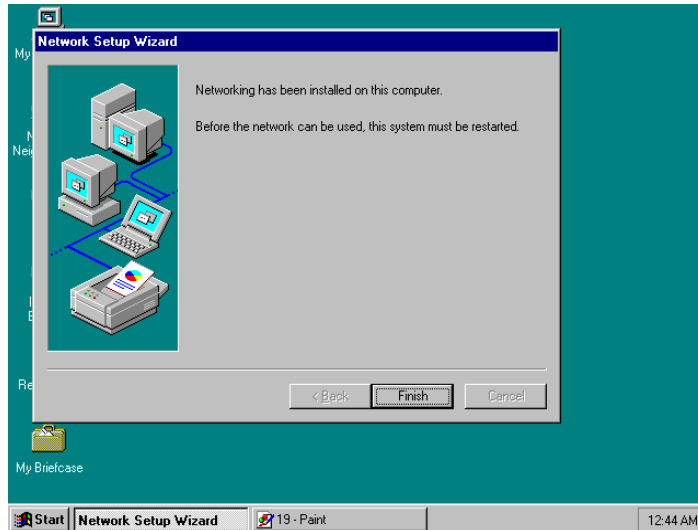

20. Click on the Yes button to restart your computer. The LAN driver installation for WIN NT4.0 is now complete.

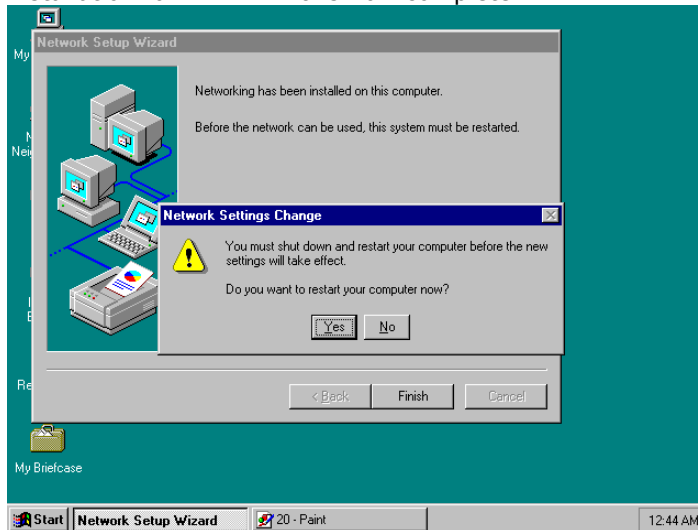

## 5.4 Audio Driver Installation

1. With the Utility CD Disk still in your CD ROM drive, open the File Manager and then select the CD-ROM drive. As soon as the system reads the disk, the VGA Menu screen below will appear on your display. Click on VIA\_AC97 from the main menu.



2. Once the Welcome screen appears on the screen, make sure to close applications that are running and then click the Next button.

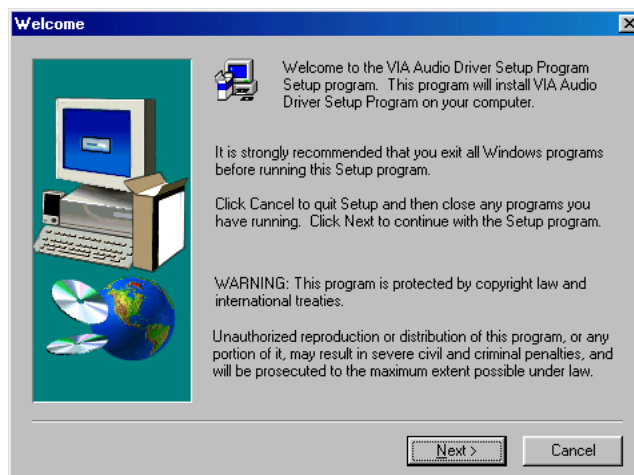

3. The Select Components dialog box is now displayed. Select on Install driver and then click on Next.

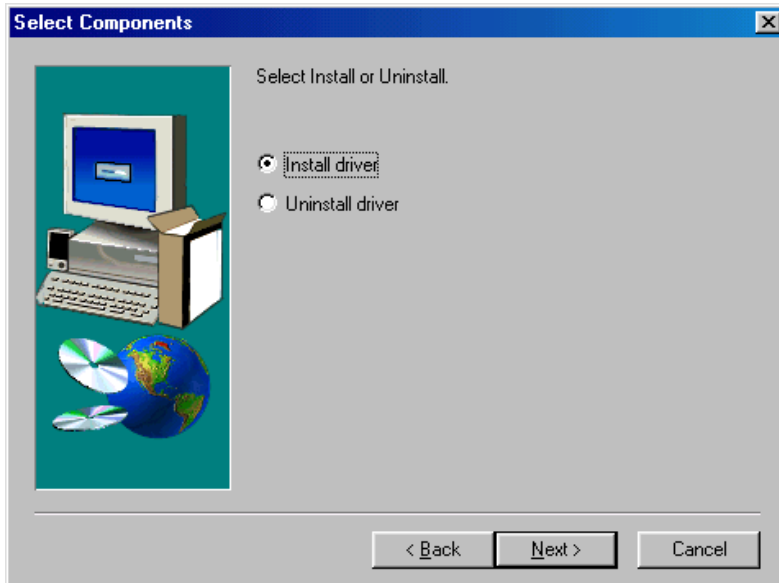

4. The program will now require the Windows installation disk for proper hardware installation. Insert the CD and then click on Next.

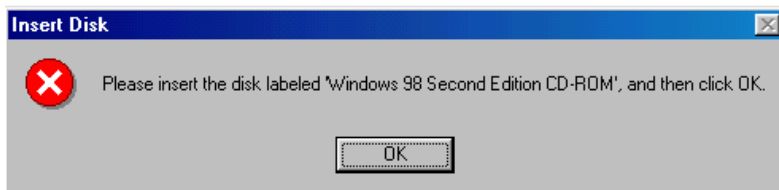

- When the display below appears on your screen, Setup is already installing and copying the related files onto your hard drive. Click on the Next button to proceed.

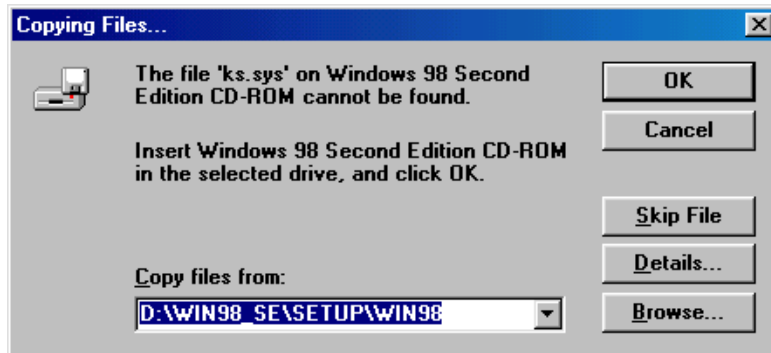

- After the audio driver installation finishes, select the Finish button to complete the installation process.

