

MEMS Flow Sensor

D6F-P0010A**Compact, Highly Reliable Flow-Sensor with Unique Dust Segregation System**

- Cyclone flow structure diverts particulate from sensor element
- PCB-mounted & connector models available
- High accuracy, reliable mass flow measurement
- Alternative to differential pressure sensing
- Measure over 200 LPM with a bypass set-up

**Ordering Information**

Model	Wiring	Flow range	Gas	Case
D6F-P0010A1	PCB-mounting model	1L/min	Air	PBT
D6F-P0010A2	Connector model	1L/min	Air	PBT
D6F-CABLE2	Cable connector assembly	-	-	-

Electrical Performance

Item	Symbol	Rating	Unit
Power supply voltage	Vcc	5 – 10	VDC
Output voltage	Vout	0.5 – 2.5	VDC

Sensor Specifications

Model	D6F-P0010A1	D6F-P0010A2
Termination	PCB Terminals	Connector JST SM03B-SRSS-TB
Flow range/ Pressure range	+ 1.0 SLM (+ 0.84 in H ₂ O)	
Applicable gas	Air (contact Omron for other gases)	
Accuracy	+/- 5% F.S. (typical test results within +/- 2% F.S.)	
Temperature characteristic	+/- 5% F.S.	
Operating temperature	-10 to 60 deg C (without freezing and condensation)	
Operating humidity	85%RH max (without freezing and condensation)	
Storage temperature	-40 to 80 deg C (without freezing and condensation)	
Storage humidity	85%RH max (without freezing and condensation)	
Output signal	Analog 0.5 to 2.5 VDC, Amplified and Temperature Compensated	
Withstand pressure	50kPa (7psi)	
Current consumption	Max 15mA (No load, Vcc=5 VDC, 25 deg C)	
Insulation resistance	20M Ohm min.(DC 500VDC, between lead terminal and case)	

Output Characteristics

Differential Pressure	Flow Rate	Output
(inH2O)	(SLM)	(V)
0.00	0.00	0.50
0.07	0.25	1.60
0.24	0.50	2.10
0.51	0.75	2.31
0.84	1.00	2.50

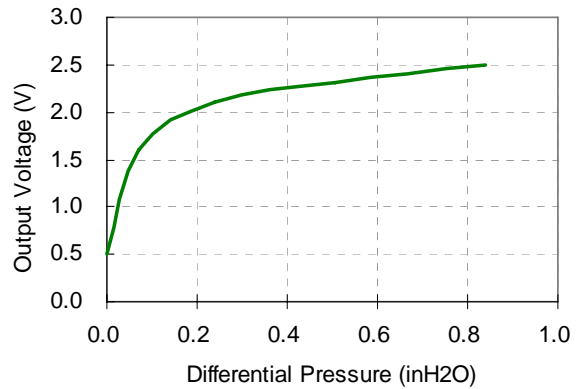

Mass flow converted into volumetric flow rate SLM (standard liters per minute) at 0 °C, 1 atm. Note, 0 to 0.5V output indicates a negative flow direction.

Repeatability, typical test results

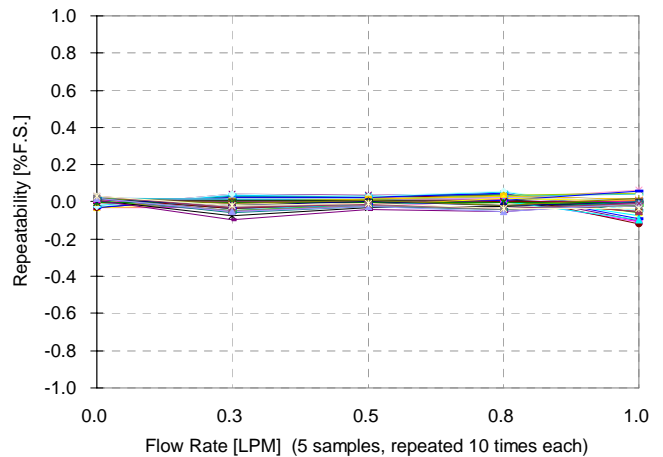
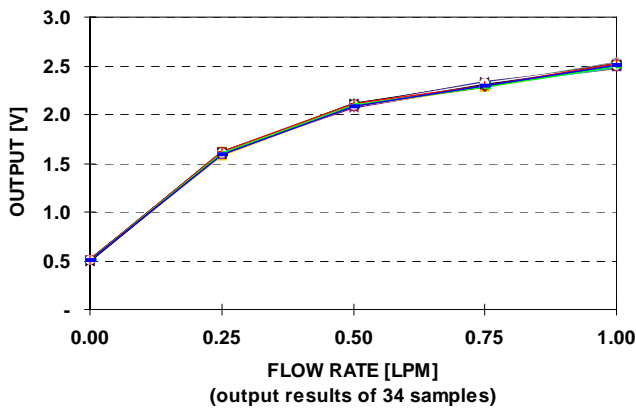

Bidirectional Dust Segregation System

The D6F-P series has a patented dust segregation design. The flow path incorporates dual centrifugal chambers, in which particulate matter follows in the outer path, away from the MEMS sensor chip regardless of the flow direction. Note, standard products are calibrated for unidirectional flow, as shown above. Contact Omron for bidirectional calibration options.

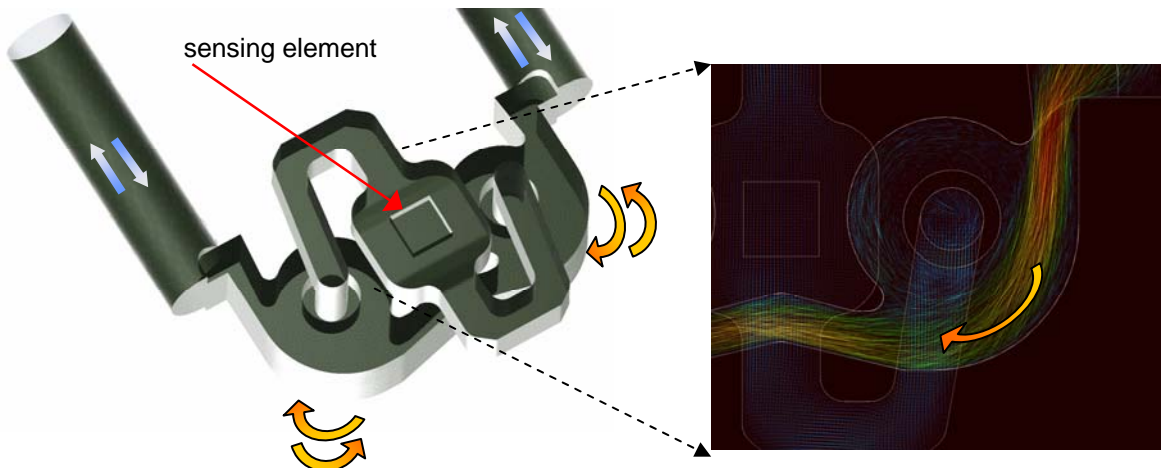

Dimensions

All dimensions are shown in mm.

Use 2 suitable M2.6 screws for mounting. Do not exceed a fixing torque of 0.59 Nm.

D6F-P0010A1 (PCB lead)

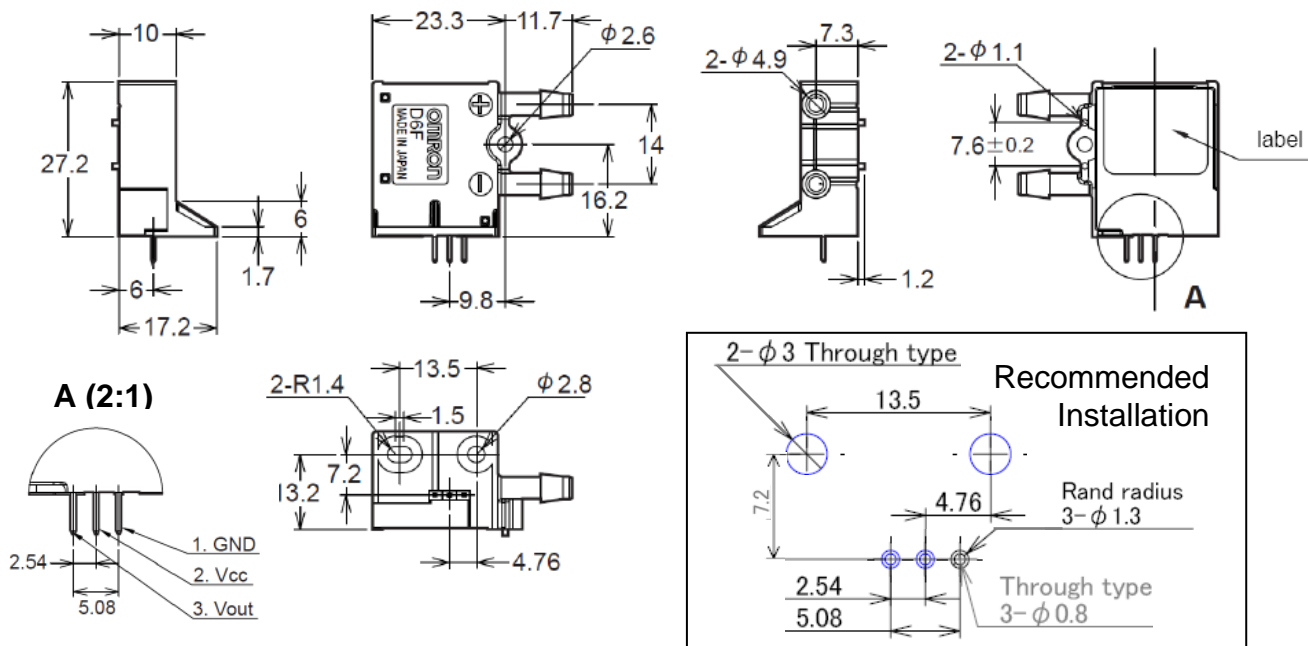

D6F-P0010A2 (connector)

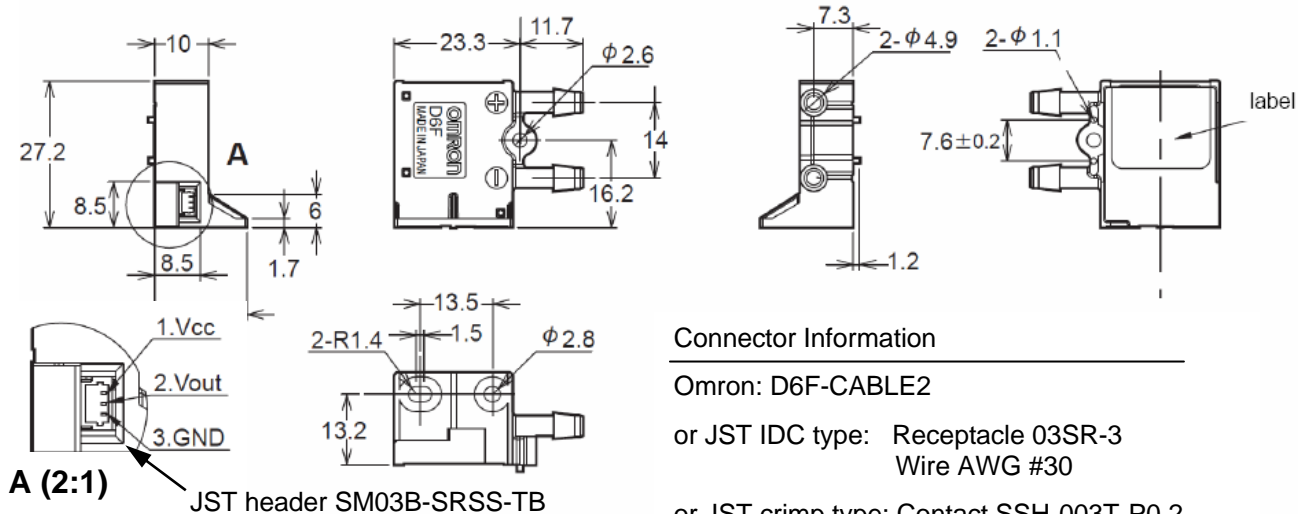

D6F-CABLE2 (optional)

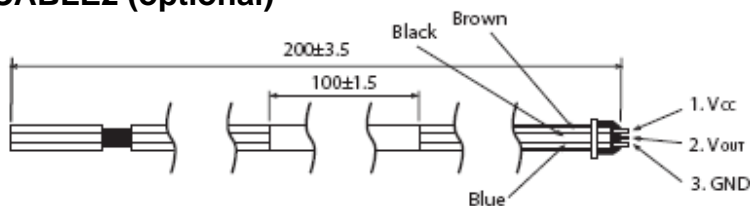

Bypass Set-up

When used in a bypass set-up, as illustrated below, the D6F-P mass flow sensors can measure flow rates far beyond the 1 LPM in-line rating. The pressure differential required to pull airflow through the sensor can be accomplished by installing a flow restrictor between the two ports or through the use of a flow cross in large ducts, as shown in the HVAC application.

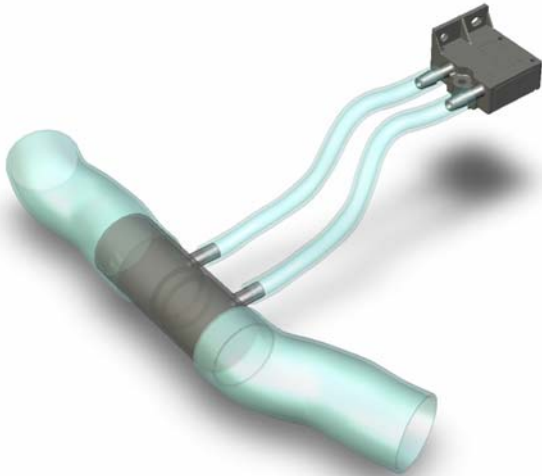

HVAC Application

The D6F-P mass flow sensor is ideal for damper control in variable air volume systems, where low flow rates are difficult to measure with differential pressure sensors.

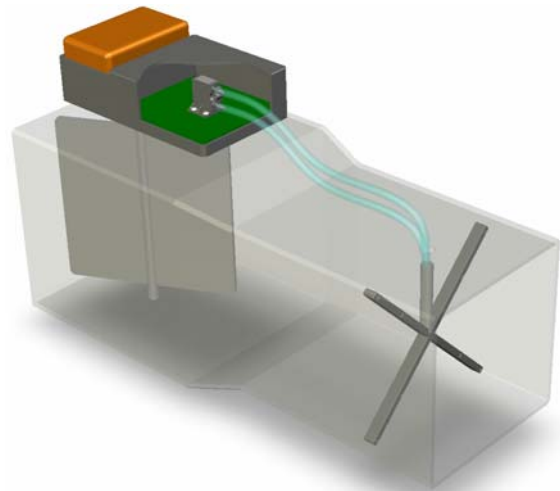

Precautions

1. Avoid use in excessively dirty, wet environments
2. Do not use in the presence of flammable gases (e.g. hydrogen, methane, ethane) and liquefied petroleum gas. In addition, do not use with corrosive gases (e.g. chlorine, sulfur, acids, alkalis, etc.).
3. Install so that gas flows from “+” to “-” stamped ports.
4. For best results (optimum accuracy), mount horizontally.
5. Use 2 suitable M2.6 screws for mounting. Do not exceed a fixing torque of 0.59 Nm.
6. Do not modify D6F- in any way.
7. Do not place any object in or close to the inlet and outlet orifices.
8. Do not use the sensor in any of the following environments:
 - a location that receives significant radiant heat
 - a place where intense light may radiate down
 - where fast changing temperatures occur
 - locations prone to freezing, high humidity, condensation
 - where large magnitudes of vibration or shock could occur
9. Noise countermeasures: VERY IMPORTANT: Take suitable precautions to minimize the effects and potential for induced electrical noise. Install away from apparatus that generates strong high frequencies, surges and spikes. Take particular care to install away from AC power transformers, live mains power lines and high power magnetic circuits. Attach a surge suppressor and a noise filter to the peripheral equipment.
10. Ensure good grounding is achieved by grounding the GND terminal to the peripheral equipment's main ground frame connection and its associated regulated power supply.
11. Do not make a direct solder connection to the integral terminals on the connector model type. The use of optional cable 'D6F-CABLE2' is recommended for attachment to ensure correct connection (D6F-P0010A2). Solder PCB terminals after securing the sensor to the board (D6F-P0010A1).
12. D6F- is a precision component. Keep in original packaging and remove only when ready for installation. Damage may occur if subjected to excessive force (e.g. dropped or kicked). Any item suspected to be damaged should be discarded.
13. Immediately following installation, a qualified person should perform checks to ensure safe, satisfactory operation.

Terms and Conditions of Sales

I. GENERAL

- Definitions:** The words used herein are defined as follows.
 - Terms:** These terms and conditions
 - Seller:** Omron Electronic Components LLC and its subsidiaries
 - Buyer:** The buyer of Products, including any end user in section III through VI
 - Products:** Products and/or services of Seller
 - Including:** Including without limitation
- Offer, Acceptance:** These Terms are deemed part of all quotations, acknowledgments, invoices, purchase orders and other documents, whether electronic or in writing, relating to the sale of Products by Seller. Seller hereby objects to any Terms proposed in Buyer's purchase order or other documents which are inconsistent with, or in addition to, these Terms.
- Distributor:** Any distributor shall inform its customer of the contents after and including section III of these Terms.

II. SALES

- Prices; Payment:** All prices stated are current, subject to change without notice by Seller. Buyer agrees to pay the price in effect at time of shipment. Payments for Products received are due net 30 days unless otherwise stated in the invoice. Buyer shall have no right to set off any amounts against the amount owing in respect of this invoice.
- Discounts:** Cash discounts, if any, will apply only on the net amount of invoices sent to Buyer after deducting transportation charges, taxes and duties, and will be allowed only if (a) the invoice is paid according to Seller's payment terms and (b) Buyer has no past due amounts owing to Seller.
- Interest:** Seller, at its option, may charge Buyer 1.5% interest per month or the maximum legal rate, whichever is less, on any balance not paid within the stated terms.
- Orders:** Seller will accept no order less than 200 U.S. dollars net billing.
- Currencies:** If the prices quoted herein are in a currency other than U.S. dollars, Buyer shall make remittance to Seller at the then current exchange rate most favorable to Seller; provided that if remittance is not made when due, Buyer will convert the amount to U.S. dollars at the then current exchange rate most favorable to Seller available during the period between the due date and the date remittance is actually made.
- Governmental Approvals:** Buyer shall be responsible for all costs involved in obtaining any government approvals regarding the importation or sale of the Products.
- Taxes:** All taxes, duties and other governmental charges (other than general real property and income taxes), including any interest or penalties thereon, imposed directly or indirectly on Seller or required to be collected directly or indirectly by Seller for the manufacture, production, sale, delivery, importation, consumption or use of the Products sold hereunder (including customs duties and sales, excise, use, turnover and license taxes) shall be charged to and remitted by Buyer to Seller.
- Financial:** If the financial position of Buyer at any time becomes unsatisfactory to Seller, Seller reserves the right to stop shipments or require satisfactory security or payment in advance. If Buyer fails to make payment or otherwise comply with these Terms or any related agreement, Seller may (without liability and in addition to other remedies) cancel any unshipped portion of Products sold hereunder and stop any Products in transit until Buyer pays all amounts, including amounts payable hereunder, whether or not then due, which are owing to it by Buyer. Buyer shall in any event remain liable for all unpaid accounts.
- Cancellation; Etc:** Orders are not subject to rescheduling or cancellation unless Buyer indemnifies Seller fully against all costs or expenses arising in connection therewith.
- Force Majeure:** Seller shall not be liable for any delay or failure in delivery resulting from causes beyond its control, including earthquakes, fires, floods, strikes or other labor disputes, shortage of labor or materials, accidents to machinery, acts of sabotage, riots, delay in or lack of transportation or the requirements of any government authority.
- Shipping; Delivery:** Unless otherwise expressly agreed in writing by Seller:
 - All sales and shipments of Products shall be FOB shipping point (unless otherwise stated in writing by Seller), at which point title to and all risk of loss of the Products shall pass from Seller to Buyer, provided that Seller shall retain a security interest in the Products until the full purchase price is paid by Buyer;
 - Delivery and shipping dates are estimates only; and
 - Seller will package Products as it deems proper for protection against normal handling and extra charges apply to special conditions.
- Claims:** Any claim by Buyer against Seller for shortage or damage to the Products occurring before delivery to the carrier must be presented in detail in writing to Seller within 30 days of receipt of shipment.

III. PRECAUTIONS

- Suitability:** IT IS THE BUYER'S SOLE RESPONSIBILITY TO ENSURE THAT ANY OMRON PRODUCT IS FIT AND SUFFICIENT FOR USE IN A MOTORIZED VEHICLE APPLICATION. BUYER SHALL BE SOLELY RESPONSIBLE FOR DETERMINING APPROPRIATENESS OF THE PARTICULAR PRODUCT WITH RESPECT TO THE BUYER'S APPLICATION INCLUDING (A) ELECTRICAL OR ELECTRONIC COMPONENTS, (B) CIRCUITS, (C) SYSTEM ASSEMBLIES, (D) END PRODUCT, (E) SYSTEM, (F) MATERIALS OR SUBSTANCES OR (G) OPERATING ENVIRONMENT. Buyer acknowledges that it alone has determined that the Products will meet their requirements of the intended use in all cases. Buyer must know and observe all prohibitions of use applicable to the Product/s.
- Use with Attention:** The followings are some examples of applications for which particular attention must be given. This is not intended to be an exhaustive list of all possible use of any Product, nor to imply that any use listed may be suitable for any Product:
 - Outdoor use, use involving potential chemical contamination or electrical interference.
 - Use in consumer Products or any use in significant quantities.

- Energy control systems, combustion systems, railroad systems, aviation systems, medical equipment, amusement machines, vehicles, safety equipment, and installations subject to separate industry or government regulations.
- Systems, machines, and equipment that could present a risk to life or property.

- Prohibited Use:** NEVER USE THE PRODUCT FOR AN APPLICATION INVOLVING SERIOUS RISK TO LIFE OR PROPERTY WITHOUT ENSURING THAT THE SYSTEM AS A WHOLE HAS BEEN DESIGNED TO ADDRESS THE RISKS, AND THAT THE PRODUCT IS PROPERLY RATED AND INSTALLED FOR THE INTENDED USE WITHIN THE OVERALL EQUIPMENT OR SYSTEM.
- Motorized Vehicle Application:** USE OF ANY PRODUCT/S FOR A MOTORIZED VEHICLE APPLICATION MUST BE EXPRESSLY STATED IN THE SPECIFICATION BY SELLER.
- Programmable Products:** Seller shall not be responsible for the Buyer's programming of a programmable Product.

IV. WARRANTY AND LIMITATION

- Warranty:** Seller's exclusive warranty is that the Products will be free from defects in materials and workmanship for a period of twelve months from the date of sale by Seller (or such other period expressed in writing by Seller). SELLER MAKES NO WARRANTY OR REPRESENTATION, EXPRESS OR IMPLIED, ABOUT ALL OTHER WARRANTIES, NON-INFRINGEMENT, MERCHANTABILITY OR FITNESS FOR A PARTICULAR PURPOSE OF THE PRODUCTS.
- Buyer Remedy:** Seller's sole obligation hereunder shall be to replace (in the form originally shipped with Buyer responsible for labor charges for removal or replacement thereof) the non-complying Product or, at Seller's election, to repay or credit Buyer an amount equal to the purchase price of the Product; provided that there shall be no liability for Seller or its affiliates unless Seller's analysis confirms that the Products were handled, stored, installed and maintained and not subject to contamination, abuse, misuse or inappropriate modification. Return of any Products by Buyer must be approved in writing by Seller before shipment.
- Limitation on Liability:** SELLER AND ITS AFFILIATES SHALL NOT BE LIABLE FOR SPECIAL, INDIRECT, INCIDENTAL OR CONSEQUENTIAL DAMAGES, LOSS OF PROFITS OR PRODUCTION OR COMMERCIAL LOSS IN ANY WAY CONNECTED WITH THE PRODUCTS, WHETHER SUCH CLAIM IS BASED IN CONTRACT, WARRANTY, NEGLIGENCE OR STRICT LIABILITY. FURTHER, IN NO EVENT SHALL LIABILITY OF SELLER OR ITS AFFILIATES EXCEED THE INDIVIDUAL PRICE OF THE PRODUCT ON WHICH LIABILITY IS ASSERTED.
- Indemnities:** Buyer shall indemnify and hold harmless Seller, its affiliates and its employees from and against all liabilities, losses, claims, costs and expenses (including attorney's fees and expenses) related to any claim, investigation, litigation or proceeding (whether or not Seller is a party) which arises or is alleged to arise from Buyer's acts or omissions under these Terms or in any way with respect to the Products.

V. INFORMATION; ETC.

- Intellectual Property:** The intellectual property embodied in the Products is the exclusive property of Seller and its affiliates and Buyer shall not attempt to duplicate it in any way without the written permission of Seller. Buyer (at its own expense) shall indemnify and hold harmless Seller and defend or settle any action brought against Seller to the extent that it is based on a claim that any Product made to Buyer specifications infringed intellectual property rights of another party.
- Property; Confidentiality:** Notwithstanding any charges to Buyer for engineering or tooling, all engineering and tooling shall remain the exclusive property of Seller. All information and materials supplied by Seller to Buyer relating to the Products are confidential and proprietary, and Buyer shall limit distribution thereof to its trusted employees and strictly prevent disclosure to any third party.
- Performance Data:** Performance data is provided as a guide in determining suitability and does not constitute a warranty. It may represent the result of Seller's test conditions, and the users must correlate it to actual application requirements.
- Change In Specifications:** Product specifications and description may be changed at any time based on improvements or other reasons. It is Seller's practice to change part numbers when published ratings or features are changed, or when significant engineering changes are made. However, some specifications of the Product may be changed without any notice.
- Errors And Omissions:** The information on Seller's website or in other documentation has been carefully checked and is believed to be accurate; however, no responsibility is assumed for clerical, typographical or proofreading errors or omissions.
- Export Controls:** Buyer shall comply with all applicable laws, regulations and licenses regarding (a) export of the Products or information provided by Seller; (b) sale of Products to forbidden or other proscribed persons or organizations; (c) disclosure to non-citizens of regulated technology or information.

VI. MISCELLANEOUS

- Waiver:** No failure or delay by Seller in exercising any right and no course of dealing between Buyer and Seller shall operate as a waiver of rights by Seller.
- Assignment:** Buyer may not assign its rights hereunder without Seller's written consent.
- Law:** These Terms are governed by Illinois law (without regard to conflict of laws). Federal and state courts in Illinois have exclusive jurisdiction for any dispute hereunder.
- Amendment:** These Terms constitute the entire agreement between Buyer and Seller relating to the Products, and no provision may be changed or waived unless in writing signed by the parties.
- Severability:** If any provision hereof is rendered ineffective or invalid, such provision shall not invalidate any other provision.