

PLEASE CHECK WWW.MOLEX.COM FOR LATEST PART INFORMATION

Part Number: [0348030211](#)
Status: **Active**
Description: CTX64 Female Terminal, D-Wind, Left Payoff, SAE 22

Documents:

[Drawing \(PDF\)](#) [RoHS Certificate of Compliance \(PDF\)](#)

General

Product Family	Crimp Terminals
Series	34803
Crimp Quality Equipment	Yes
Product Name	CTX64

Physical

Durability (mating cycles max)	10
Gender	Female
Material - Metal	Copper Alloy
Material - Plating Mating	Tin
Material - Plating Termination	Tin
Packaging Type	Reel
Termination Interface: Style	Crimp or Compression
Wire Insulation Diameter	1.10 to 1.65mm
Wire Size AWG	22
Wire Size mm ²	0.22 TO 0.35

Electrical

Current - Maximum per Contact	7A
Voltage - Maximum	250V

Material Info

Reference - Drawing Numbers

Sales Drawing	SD-34803-001
---------------	--------------

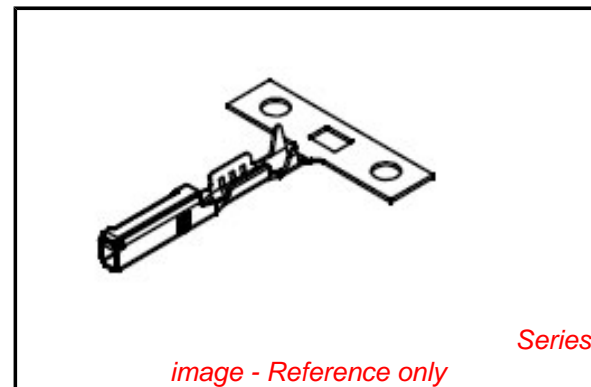

EU RoHS

**ELV and RoHS
Compliant**
**REACH SVHC
Not Reviewed**
**Halogen-Free
Status
Not Reviewed**

China RoHS



**Need more information on product
environmental compliance?**

Email productcompliance@molex.com
 For a multiple part number RoHS Certificate of Compliance, [click here](#)

Please visit the [Contact Us](#) section for any non-product compliance questions.

Search Parts in this Series
[34803Series](#)

Mates With
 0.64 by 0.64mm blade

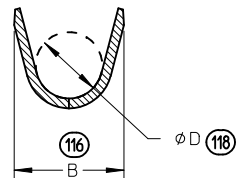

SECTION Y-Y
SCALE 10:1

INSULATION GRIP

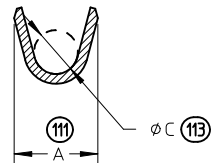

SECTION Z-Z
SCALE 10:1

CONDUCTOR GRIP

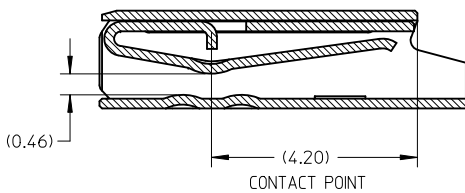
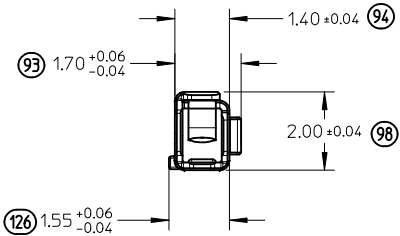
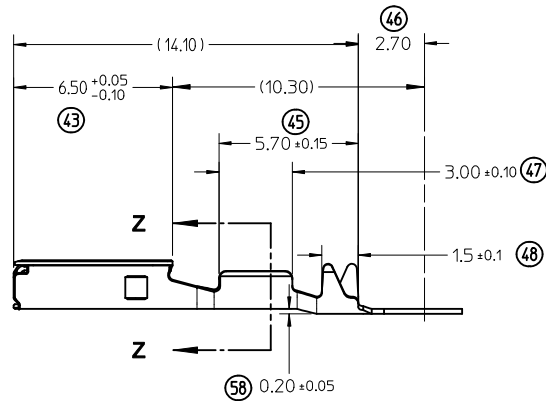
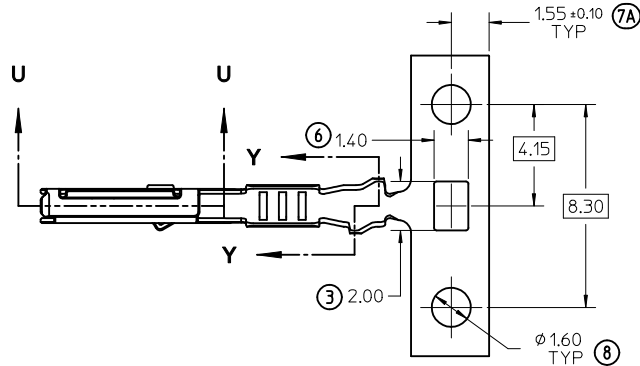
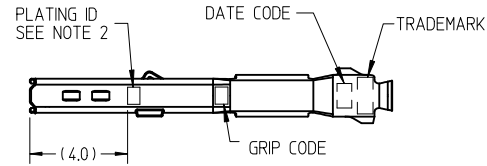

SECTION U-U
SCALE 10:1

CONTACT POINT

PART NUMBERS		GRIP CODE	WIRE GAUGE			PLATING	DIM A +0.20	DIM B +0.30	DIM C +0.10	DIM D +0.20
D-WIND (LEFT PAYOFF)	B-WIND (RIGHT PAYOFF)		ISO mm ²	JASO mm ²	SAE gauge					
34803-0211	34803-0213	S	0.22-0.35	0.3	22	TIN	1.80	2.40	0.90	1.36
34803-0212	34803-0214	L	0.50-0.75	0.50-0.85	20	(Sn)	2.15	2.50	1.20	1.72

ISO VIEWS
NOT TO SCALE



NOTES: (UNLESS OTHERWISE SPECIFIED)

1. MATERIAL: COPPER ALLOY
2. PLATING MARK: TIN (Sn) - NO MARK
3. PACKAGING PER PK-31301-053
4. CRIMPING PER CS-34803-001
5. PROBING AT ANY LOCATION ON THE TERMINAL BEAM IS NOT PERMITTED

ENTER DESCRIPTION EC NO: UAU2010-1351 DR: M. FERGUSON 2010/01/20 CHK'D: HEMNANI 2010/01/20 APPR: B. MOSER 2010/01/20 DESCRIPTION REV A	QUALITY SYMBOLS ▽=0 ▽=0	GENERAL TOLERANCES (UNLESS SPECIFIED)	DIMENSION STYLE MM ONLY	SCALE 5:1	DESIGN UNITS METRIC	THIRD ANGLE PROJECTION																		
		<table border="1"> <thead> <tr> <th></th> <th>mm</th> <th>INCH</th> </tr> </thead> <tbody> <tr> <td>4 PLACES</td> <td>± ---</td> <td>± ---</td> </tr> <tr> <td>3 PLACES</td> <td>± 0.08</td> <td>± ---</td> </tr> <tr> <td>2 PLACES</td> <td>± 0.08</td> <td>± ---</td> </tr> <tr> <td>1 PLACE</td> <td>± 0.08</td> <td>± ---</td> </tr> <tr> <td colspan="3">ANGULAR ± 1 °</td> </tr> </tbody> </table>		mm	INCH	4 PLACES	± ---	± ---	3 PLACES	± 0.08	± ---	2 PLACES	± 0.08	± ---	1 PLACE	± 0.08	± ---	ANGULAR ± 1 °			DRAWN BY K. FERGUSON	DATE 1-15-10	TITLE CTX64 FEMALE TERMINAL	
		mm	INCH																					
	4 PLACES	± ---	± ---																					
3 PLACES	± 0.08	± ---																						
2 PLACES	± 0.08	± ---																						
1 PLACE	± 0.08	± ---																						
ANGULAR ± 1 °																								
		CHECKED BY D. HEMNANI	DATE 1-15-10	MOLEX INCORPORATED																				
		APPROVED BY B. MOSER	DATE 1-15-10	MATERIAL NO. SEE TABLE	DOCUMENT NO. SD-34803-001	SHEET NO. 1 OF 1																		

THIS DRAWING CONTAINS INFORMATION THAT IS PROPRIETARY TO MOLEX INCORPORATED AND SHOULD NOT BE USED WITHOUT WRITTEN PERMISSION