

PLEASE CHECK WWW.MOLEX.COM FOR LATEST PART INFORMATION

Part Number: **0346750001**
Status: **Active**
Overview: mx150 sealed connector system
Description: 5.00mm (.197") Pitch MX150™ 2 Way Inline Male Assembly with TPA, Single Row, 2 Circuits, Keying Option C, without Clip Slot, Black

Documents:

[3D Model](#)
[Application Specification \(PDF\)](#)
[Drawing \(PDF\)](#)
[Product Specification PS-34062-000 \(PDF\)](#)
[RoHS Certificate of Compliance \(PDF\)](#)

General

Product Family	Crimp Housings
Series	34675
Comments	No Clipslot
More Detailed Tech Information	http://ewcap.uscarteams.org
Overview	<u>mx150 sealed connector system</u>
Product Name	MX150™

Physical

Circuits (maximum)	2
Circuits Detail	2
Color - Resin	Black
Gender	Male
Glow-Wire Compliant	No
Keying to Mating Part	Yes
Lock to Mating Part	Yes
Material - Resin	Nylon
Number of Rows	2
Packaging Type	Bag
Panel Mount	No
Pitch - Mating Interface (in)	0.197 In
Pitch - Mating Interface (mm)	5.00 mm
Pitch - Term. Interface (in)	0.197 In
Pitch - Term. Interface (mm)	5.00 mm
Polarized to Mating Part	Yes
Stackable	No
Temperature Range - Operating	-40°C to +120°C

Electrical

Current - Maximum per Contact	22A
-------------------------------	-----

Material Info

Reference - Drawing Numbers

Application Specification	AS-34062-000
Packaging Specification	PK-31300-635
Product Specification	PS-34062-000
Sales Drawing	SD-34675-001



EU RoHS

ELV and RoHS Compliant
REACH SVHC Contains SVHC: No
Halogen-Free Status
Not Reviewed

China RoHS



Need more information on product environmental compliance?

Email productcompliance@molex.com
 For a multiple part number RoHS Certificate of Compliance, [click here](#)

Please visit the [Contact Us](#) section for any non-product compliance questions.

Search Parts in this Series

[34675Series](#)

Mates With

[340620023](#) MX150™ Sealed Female Receptacle

Use With

[34080](#) Male Terminal

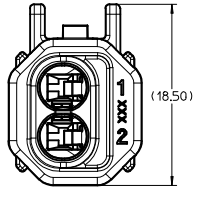

KEY OPTION C

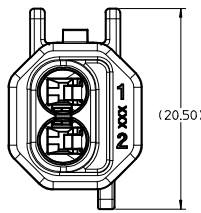

KEY OPTION B

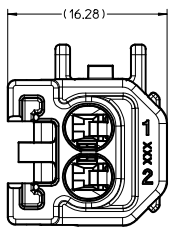

KEY OPTION C W/CLIP SLOT

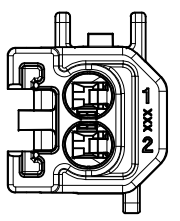

KEY OPTION B W/CLIP SLOT

TERMINAL INFORMATION 1.5 MM CABLE SEAL BLADE				CABLE SEAL INFORMATION			
TERMINAL PART NUMBER	GRIP SIZE	PLATING	PAYOFF DIRECTION	OSR PART NUMBER	YAZAKI PART NUMBER	COLOR	WIRE OD RANGE
34080-0001	14	TIN	RIGHT	-	7158-3033-40	GRAY	2.54 - 2.69
34080-1001	14	TIN	LEFT	-	7158-3033-40	GRAY	2.54 - 2.69
34080-0001	16	TIN	RIGHT	E-1644-02	-	YELLOW	2.18 - 2.40
34080-1001	16	TIN	LEFT	E-1644-02	-	YELLOW	2.18 - 2.40
34080-0002	18/20	TIN	RIGHT	E-1644-00	-	GREEN	1.70 - 2.10
34080-1002	18/20	TIN	LEFT	E-1644-00	-	GREEN	1.70 - 2.10
34080-0003	22	TIN	RIGHT	E-1644-01	-	PINK	1.40 - 1.65
34080-1003	22	TIN	LEFT	E-1644-01	-	PINK	1.40 - 1.65

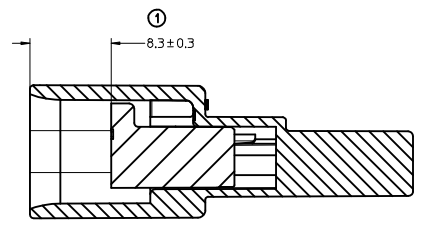

SECTION A-A
TPA SHOWN IN PRE-LOCK POSITION

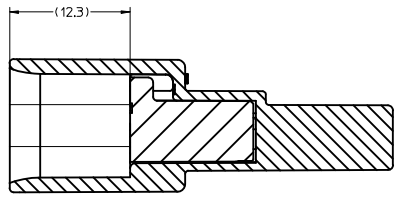

SECTION A-A
TPA SHOWN IN FINAL LOCK POSITION

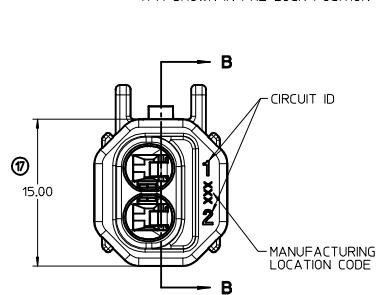

(Ø23.75)
MIN PASS-THRU
0.5 MM PER SIDE
CLEARANCE

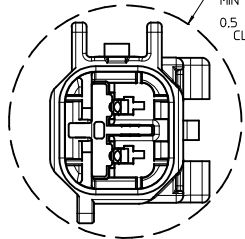

KEY OPTION B W/CLIP SLOT

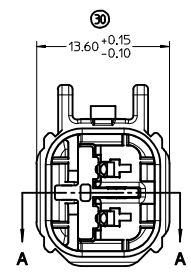

(Ø21.00)
MIN PASS-THRU
0.5 MM PER SIDE
CLEARANCE

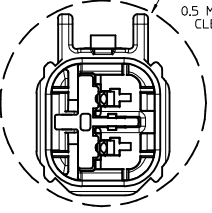

KEY OPTION C

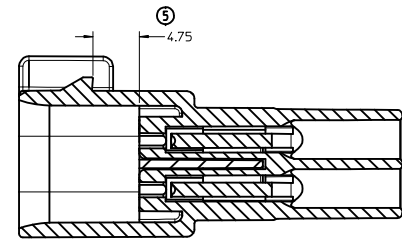
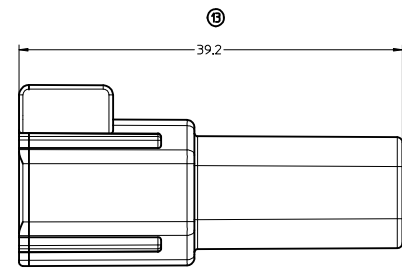

SECTION B-B

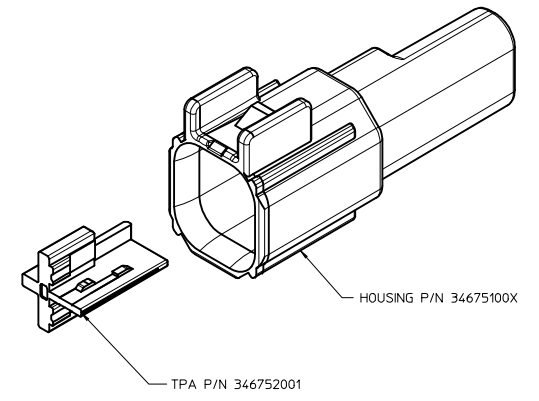

- NOTES: UNLESS OTHERWISE SPECIFIED
- PART MUST CONFORM TO SAE/USCAR-2 REV. 4 CLASS 3 EXCEPTIONS:
a) THE FORCE TO MOVE THE TPA FROM FINAL-LOCK TO PRE-LOCK SHALL NOT BE LESS THAN 12 N
b) POLARIZATION FEATURE EFFECTIVENESS: CONFORMS TO USCAR-2 REV 5
 - MATERIAL: HOUSING & TPA NYLON 6 30% GLASS FILLED.
 - SHALL CONFORM TO PRODUCT SPECIFICATION PS-34675-000
 - SHALL CONFORM TO PACKAGING SPECIFICATION PK-31300-635
 - ASSEMBLY SHIPPED WITH TPA IN PRE-LOCK POSITION (SEE SECTION A-A PRE-LOCK), UPON FULL TERMINAL ASSEMBLY, EACH TPA MUST BE SNAPPED INTO ITS FINAL-LOCK POSITION.
 - DESIGNED TO MATE WITH RECEPTACLE ASSEMBLY SPECIFIED IN CHART.
 - FOR BLADE TERMINALS TO BE USED WITH THIS ASSEMBLY SEE CHART. TERMINAL SALES DRAWING NUMBER: 34080-001

ASSEMBLY NUMBER	KEY OPTION	COLOR	CLIPSLOT	MATING RECEPTACLE ASSEMBLY PART NUMBER
34675-0001	C	BLACK	NO	34062-0023/34062-0033
34675-0002	B	GRAY	NO	34062-0022/34062-0032
34675-0003	C	BLACK	YES	34062-0023/34062-0033
34675-0004	B	GRAY	YES	34062-0022/34062-0032

ENTER DESCRIPTION EC NO. JAU2009-0045 DRAWN BY M. VANSIAMBRO 2008/07/15 CHKD BY S. VERZYL 2008/07/16 APPR. BY KYOSHI 2008/07/16	QUALITY SYMBOLS ▽=0 ▽=0	GENERAL TOLERANCES (UNLESS SPECIFIED)		DIMENSION STYLE MM ONLY		SCALE 4:1	DESIGN UNITS METRIC	THIRD ANGLE PROJECTION	
		4 PLACES ± --- ± --- 3 PLACES ± --- ± --- 2 PLACES ± 0.10 ± --- 1 PLACE ± 0.2 ± ---	mm INCH ± --- ± --- ± --- ± --- ± --- ± ---	APPROVED BY DATE S. MARCEAU		TITLE 2 WAY INLINE MALE ASSEMBLY		MATERIAL NO. DOCUMENT NO. SEE CHART SD-34675-001	
		DRAFT WHERE APPLICABLE MUST REMAIN WITHIN DIMENSIONS		APPROVED BY DATE S. MARCEAU		SHEET NO. 1 OF 1		MOLEX INCORPORATED	