

Load Switch with Level-Shift

| PRODUCT SUMMARY | | |
|-----------------|---------------------------|-----------|
| V_{DS2} (V) | $r_{DS(on)}$ (Ω) | I_D (A) |
| 4.5 to 20 | 0.075 @ $V_{IN} = 10$ V | ± 2.3 |
| | 0.120 @ $V_{IN} = 5.0$ V | ± 1.9 |
| | 0.145 @ $V_{IN} = 4.5$ V | ± 1.7 |

FEATURES

- 4.5-V Rated
- ESD Protected: 3000 V
- 105-m Ω Low $r_{DS(on)}$ TrenchFET®
- 4.5 to 20-V Input
- 1.5 to 8 -V Logic Level Control
- Low Profile, Small Footprint TSOP-6 Package
- 3000-V ESD Protection On Input Switch, $V_{ON/OFF}$
- Adjustable Slew-Rate



RoHS
COMPLIANT

DESCRIPTION

The Si3861BDV includes a p- and n-channel MOSFET in a single TSOP-6 package. The low on-resistance p-channel TrenchFET® is tailored for use as a load switch. The n-channel, with an external resistor, can be used as a

level-shift to drive the p-channel load-switch. The n-channel MOSFET has internal ESD protection and can be driven by logic signals as low as 1.5-V. The Si3861BDV operates on supply lines from 4.5 to 20-V, and can drive loads up to 2.3 A.

APPLICATION CIRCUITS

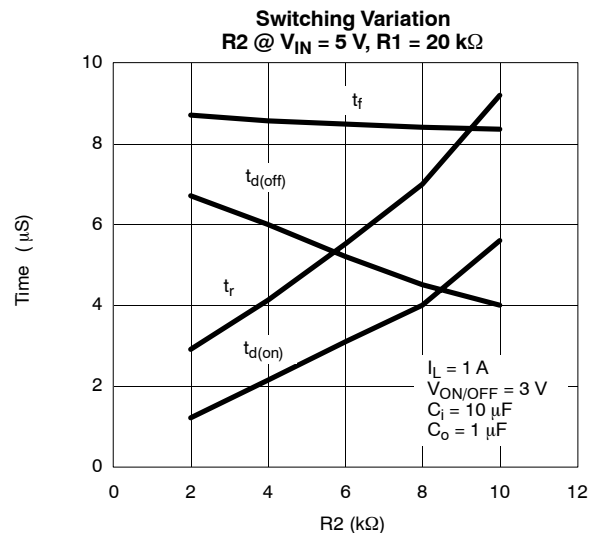
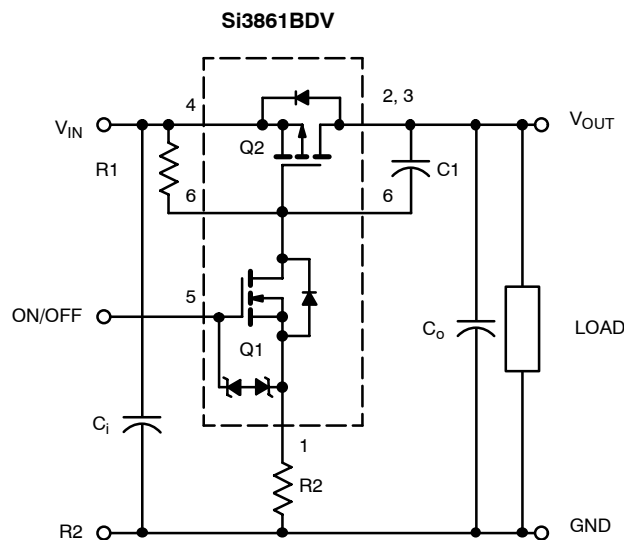

Note: For R2 switching variations with other $V_{IN}/R1$ combinations See Typical Characteristics

| COMPONENTS | | |
|------------|----------------------------|---|
| R1 | Pull-Up Resistor | Typical 10 k Ω to 1 m Ω * |
| R2 | Optional Slew-Rate Control | Typical 0 to 100 k Ω * |
| C1 | Optional Slew-Rate Control | Typical 1000 pF |

*Minimum R1 value should be at least 10 x R2 to ensure Q1 turn-on.

The Si3861BDV is ideally suited for high-side load switching in portable applications. The integrated n-channel level-shift device saves space by reducing external components. The slew rate is set externally so that rise-times can be tailored to different load types.

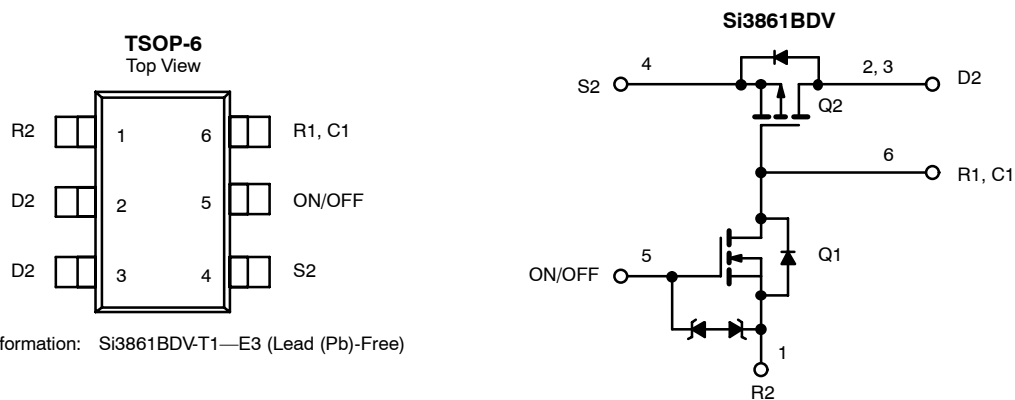
FUNCTIONAL BLOCK DIAGRAM

Ordering Information: Si3861BDV-T1—E3 (Lead (Pb)-Free)

ABSOLUTE MAXIMUM RATINGS ($T_A = 25^\circ\text{C}$ UNLESS OTHERWISE NOTED)

| Parameter | Symbol | Limit | Unit |
|--|----------------------------|------------|------------------|
| Input Voltage | V_{IN} | 20 | V |
| ON/OFF Voltage | $V_{ON/OFF}$ | 8 | |
| Load Current | Continuous ^{a, b} | ± 2.3 | A |
| | Pulsed ^{b, c} | ± 4 | |
| Continuous Intrinsic Diode Conduction ^a | I_S | -1 | |
| Maximum Power Dissipation ^a | P_D | 0.83 | W |
| Operating Junction and Storage Temperature Range | T_J, T_{stg} | -55 to 150 | $^\circ\text{C}$ |
| ESD Rating, MIL-STD-883D Human Body Model (100 pF, 1500 Ω) | ESD | 3 | kV |

THERMAL RESISTANCE RATINGS

| Parameter | Symbol | Typical | Maximum | Unit |
|---|------------|---------|---------|---------------------------|
| Maximum Junction-to-Ambient (continuous current) ^a | R_{thJA} | 120 | 150 | $^\circ\text{C}/\text{W}$ |
| Maximum Junction-to-Foot (Q2) | R_{thJF} | 60 | 80 | |

SPECIFICATIONS ($T_J = 25^\circ\text{C}$ UNLESS OTHERWISE NOTED)

| Parameter | Symbol | Test Condition | Min | Typ | Max | Unit | |
|------------------------------------|--------------|---|-------------------------|------|-------|---------------|----------|
| OFF Characteristics | | | | | | | |
| Reverse Leakage Current | I_{FL} | $V_{IN} = 30\text{ V}, V_{ON/OFF} = 0\text{ V}$ | | | 1 | μA | |
| Diode Forward Voltage | V_{SD} | $I_S = -1\text{ A}$ | | -0.8 | -1 | V | |
| ON Characteristics | | | | | | | |
| Input Voltage Range | V_{IN} | | 4.5 | | 20 | V | |
| On-Resistance (p-channel) @ 1 A | $r_{DS(on)}$ | $V_{ON/OFF} = 1.5\text{ V}$ $I_D = 1\text{ A}$ | $V_{IN} = 10\text{ V}$ | | 0.060 | 0.075 | Ω |
| | | | $V_{IN} = 5.0\text{ V}$ | | 0.096 | 0.120 | |
| | | | $V_{IN} = 4.5\text{ V}$ | | 0.115 | 0.145 | |
| On-State (p-channel) Drain-Current | $I_{D(on)}$ | $V_{IN-OUT} \leq 0.2\text{ V}, V_{IN} = 10\text{ V}, V_{ON/OFF} = 1.5\text{ V}$ | 1 | | | A | |
| | | $V_{IN-OUT} \leq 0.3\text{ V}, V_{IN} = 5\text{ V}, V_{ON/OFF} = 1.5\text{ V}$ | 1 | | | | |

Notes

- Surface Mounted on FR4 Board.
- $V_{IN} = 12\text{ V}, V_{ON/OFF} = 8\text{ V}, T_A = 25^\circ\text{C}$.
- Pulse test: pulse width $\leq 300\ \mu\text{s}$, duty cycle $\leq 2\%$.

Stresses beyond those listed under "Absolute Maximum Ratings" may cause permanent damage to the device. These are stress ratings only, and functional operation of the device at these or any other conditions beyond those indicated in the operational sections of the specifications is not implied. Exposure to absolute maximum rating conditions for extended periods may affect device reliability.



TYPICAL CHARACTERISTICS (25°C UNLESS NOTED)

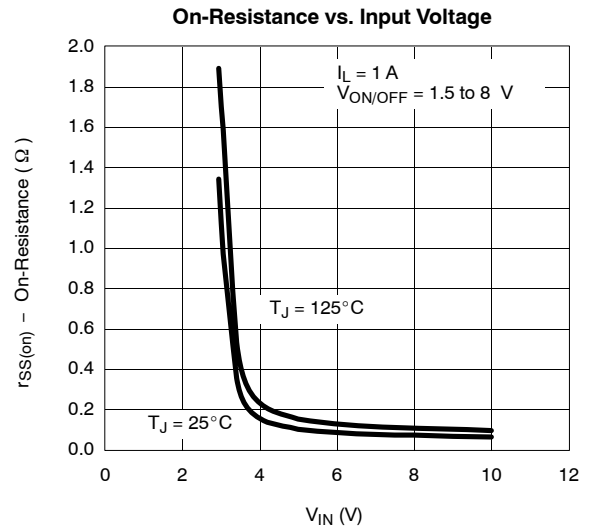
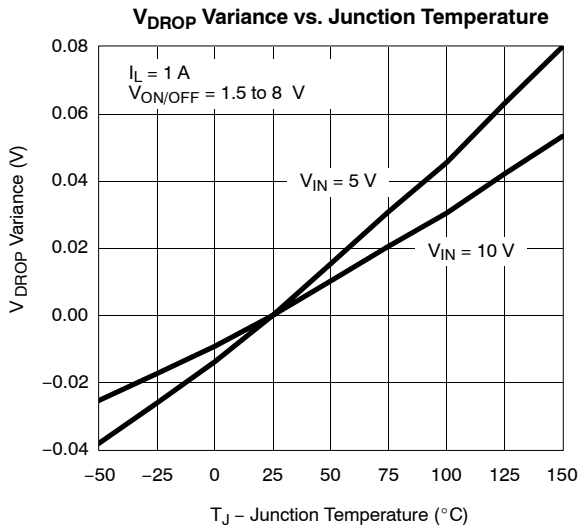
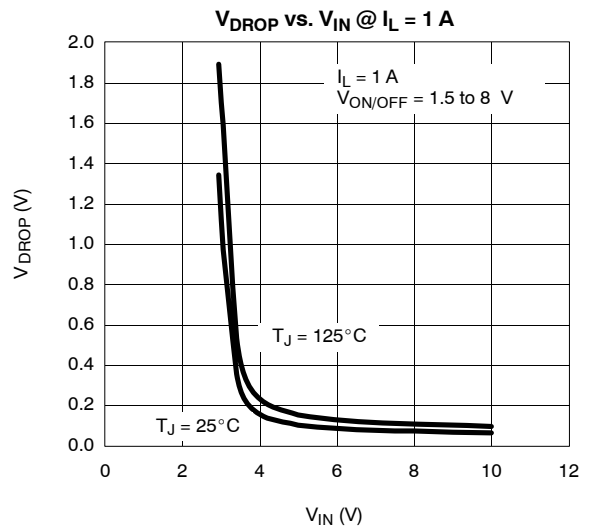
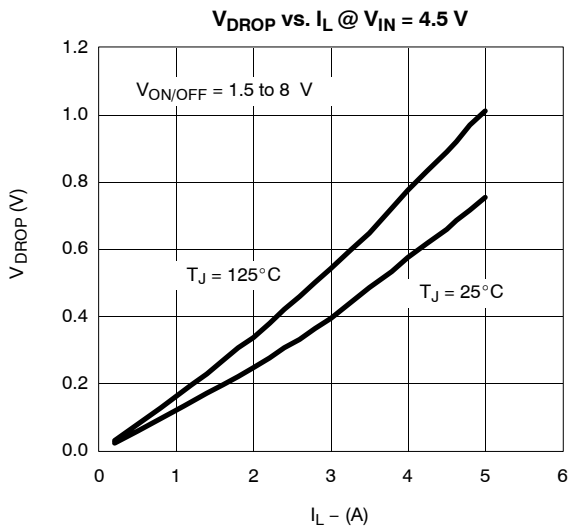
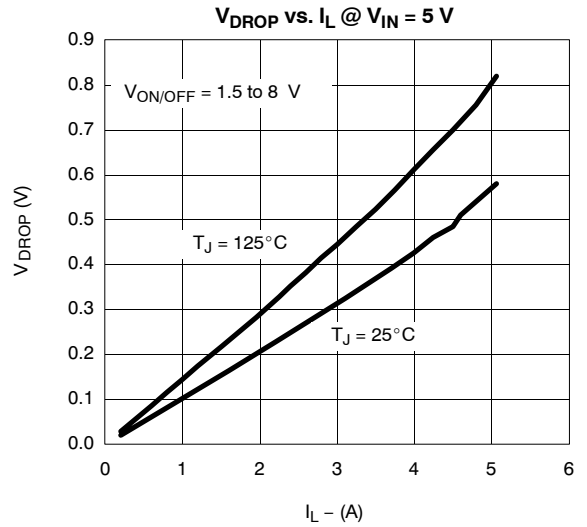
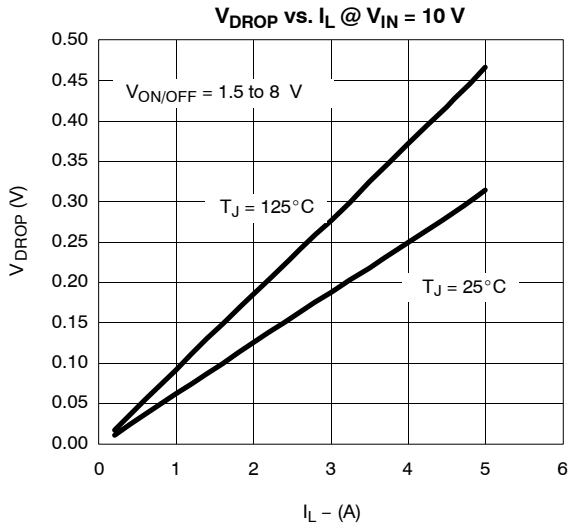



TYPICAL CHARACTERISTICS (25 °C UNLESS NOTED)

Normalized On-Resistance vs. Junction Temperature

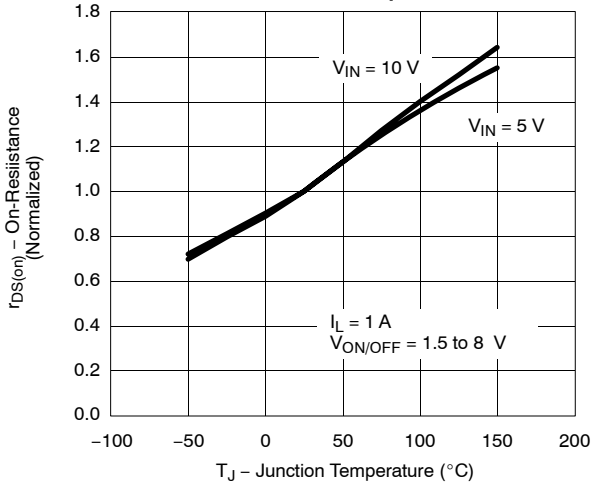

Switching Variation R2 @ V_IN = 10 V, R1 = 20 kΩ

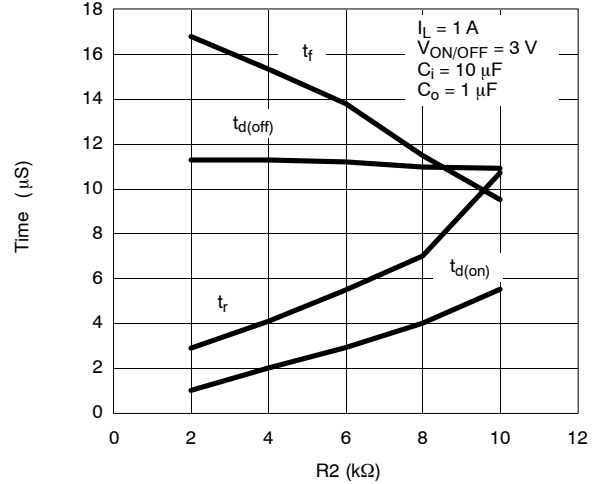

Switching Variation R2 @ V_IN = 5 V, R1 = 20 kΩ

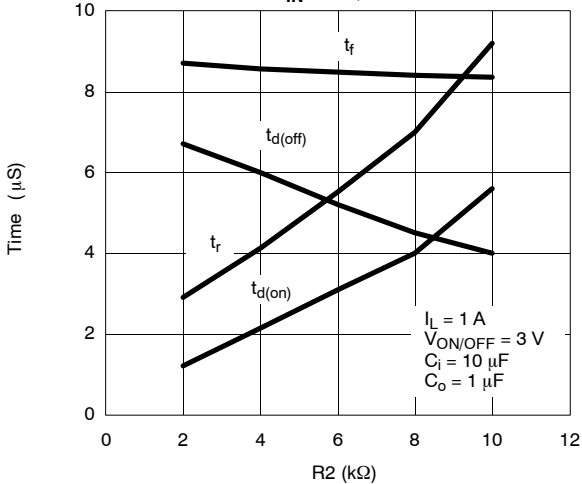

Switching Variation R2 @ V_IN = 4.5 V, R1 = 20 kΩ

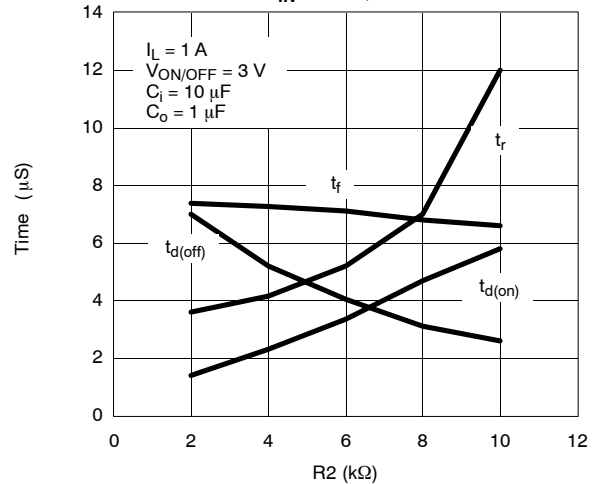

Switching Variation R2 @ V_IN = 10 V, R1 = 300 kΩ

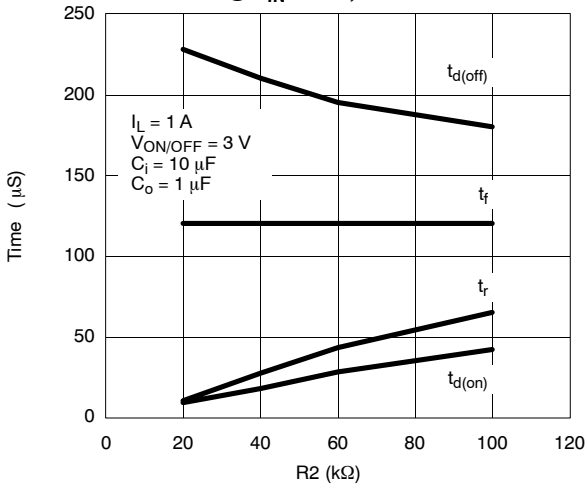

Switching Variation R2 @ V_IN = 5 V, R1 = 300 kΩ

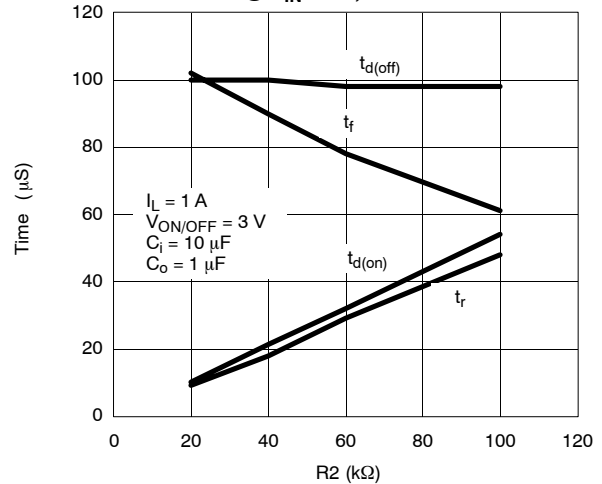



TYPICAL CHARACTERISTICS (25 °C UNLESS NOTED)

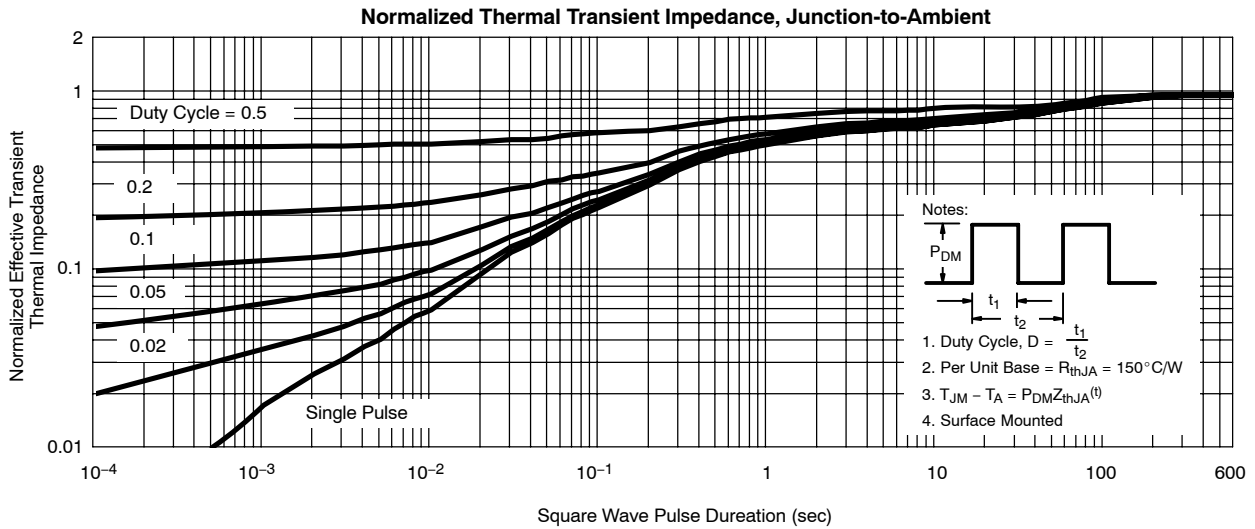
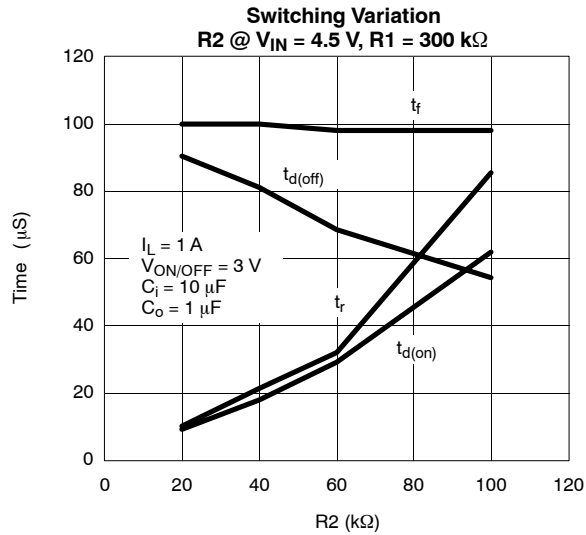

Vishay Siliconix maintains worldwide manufacturing capability. Products may be manufactured at one of several qualified locations. Reliability data for Silicon Technology and Package Reliability represent a composite of all qualified locations. For related documents such as package/tape drawings, part marking, and reliability data, see <http://www.vishay.com/ppg?73343>.



Notice

Specifications of the products displayed herein are subject to change without notice. Vishay Intertechnology, Inc., or anyone on its behalf, assumes no responsibility or liability for any errors or inaccuracies.

Information contained herein is intended to provide a product description only. No license, express or implied, by estoppel or otherwise, to any intellectual property rights is granted by this document. Except as provided in Vishay's terms and conditions of sale for such products, Vishay assumes no liability whatsoever, and disclaims any express or implied warranty, relating to sale and/or use of Vishay products including liability or warranties relating to fitness for a particular purpose, merchantability, or infringement of any patent, copyright, or other intellectual property right.

The products shown herein are not designed for use in medical, life-saving, or life-sustaining applications. Customers using or selling these products for use in such applications do so at their own risk and agree to fully indemnify Vishay for any damages resulting from such improper use or sale.