

AT90-1106

Digital Attenuator
50.0 dB, 6-Bit, TTL Driver, DC-2.4 GHz

Rev. V13

Features

- Attenuation: 1 dB Steps to 50 dB
- Single Positive Supply
- Contains Internal DC to DC Converter
- Low DC Power Consumption
- Small Footprint, JEDEC Package
- Integral TTL Driver
- 50 ohm Impedance
- CSP-1 Package

Description

M/A-COM's AT90-1106 is a GaAs FET 6-bit digital attenuator with integral TTL driver. Step size is 1 dB providing a 50 dB total attenuation range. This device is in a PQFN plastic surface mount package. AT90-1106 is ideally suited for use where accuracy, fast speed, very low power consumption and low costs are required. For dual supply designs without switching noise, use AT90-0106.

Functional Schematic

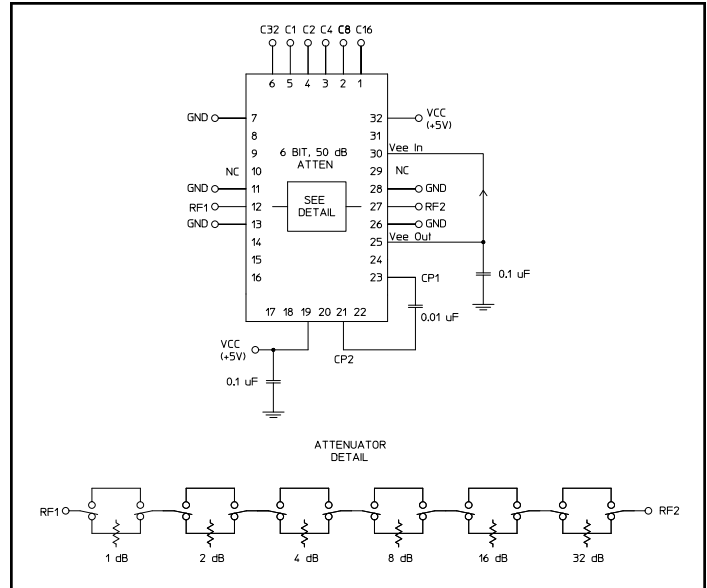

Pin Configuration¹

Pin No.	Function	Pin No.	Function
1	C16	17	NC
2	C8	18	NC
3	C4	19	+Vcc
4	C2	20	NC
5	C1	21	Cp
6	C32	22	NC
7	GND	23	Cp
8	NC	24	NC
9	NC	25	-Vee ³
10	NC ²	26	GND
11	GND	27	RF2
12	RF1	28	GND
13	GND	29	NC ²
14	NC	30	-Vee ³
15	NC	31	NC
16	NC	32	+Vcc

1. The exposed pad centered on the package bottom must be connected to RF and DC ground. (For PQFN Packages)
2. Pins 10 & 29 must be isolated
3. -Vee is produced internally and requires a .1µF cap to GND. Generated noise is typical of switching DC-DC Converters.

Ordering Information

Part Number	Package
AT90-1106	Bulk Packaging
AT90-1106TR	1000 piece reel
AT90-1106-TB	Sample Test Board

Note: Reference Application Note M513 for reel size information.

ADVANCED: Data Sheets contain information regarding a product M/A-COM Technology Solutions is considering for development. Performance is based on target specifications, simulated results, and/or prototype measurements. Commitment to develop is not guaranteed.
PRELIMINARY: Data Sheets contain information regarding a product M/A-COM Technology Solutions has under development. Performance is based on engineering tests. Specifications are typical. Mechanical outline has been fixed. Engineering samples and/or test data may be available. Commitment to produce in volume is not guaranteed.

• North America Tel: 800.366.2266 • Europe Tel: +353.21.244.6400
 • India Tel: +91.80.4155721 • China Tel: +86.21.2407.1588
 Visit www.macomtech.com for additional data sheets and product information.

M/A-COM Technology Solutions Inc. and its affiliates reserve the right to make changes to the product(s) or information contained herein without notice.

Digital Attenuator 50.0 dB, 6-Bit, TTL Driver, DC-2.4 GHz

Rev. V13

Electrical Specifications: $T_A = 25^\circ\text{C}$, $Z_0 = 50\Omega$

Parameter	Test Conditions	Frequency	Units	Min	Typ	Max
Insertion Loss	—	DC - 2.4 GHz	dB	—	5.5	6.0
Attenuation Accuracy	Individual Bits 1-2-4-8-16-32 dB Any Combination of Bits 1 to 50 dB	DC - 2.4 GHz	dB	—	—	$\pm(.3 + 5\%$ of atten setting)
		DC - 2.4 GHz	dB	—	—	$\pm(.5 + 8\%$ of atten setting)
VSWR	Full Range	DC - 2.4 GHz	Ratio	—	1.8:1	2:1
Switching Speed	50% Cntl to 90%/10% RF 10% to 90% or 90% to 10%	—	ns	—	75	—
		—	ns	—	20	—
1 dB Compression	—	50 MHz	dBm	—	+21	—
		0.5 - 2.4 GHz	dBm	—	+24	—
Input IP_3	Two-tone inputs up to +5 dBm	50 MHz	dB	—	+35	—
		0.5-2.4 GHz	dB	—	+48	—
V_{CC}	—	—	V	4.75	5.0	5.25
V_{IL} V_{IH}	LOW-level input voltage HIGH-level input voltage	—	V	0.0	—	0.8
		—	V	2.0	—	5.0
lin (Input Leakage Current)	$V_{in} = V_{CC}$ or GND	—	μA	-1.0	—	1.0
I_{CC}^4	V_{CC} min to max, Logic "0" or "1"	—	mA	—	6	10
Turn-on Current ⁵	For guaranteed start-up	—	mA	—	—	125
ΔI_{CC} (Additional Supply Current Per TTL Input Pin)	$V_{CC} = \text{Max}$, $V_{cntrl} = V_{CC} - 2.1 \text{ V}$	—	mA	—	—	1.0
Switching Noise	Generated from DC-DC Converter with recommended capacitors	3.5 MHz	dBm	—	-93	—
Thermal Resistance θ_{jc}	—	—	$^\circ\text{C/W}$	—	15	—

- During turn-on, the device requires an initial "Turn-on Current". Once operational, I_{CC} will drop to the specified levels.
- The DC-DC converter is guaranteed to start in 100 μs as long as the power supplies can provide a minimum of 100 mA "Turn-on Current".

Absolute Maximum Ratings^{6,7}

Parameter	Absolute Maximum
Max. Input Power	+27 dBm
	+34 dBm
V_{CC}	$-0.5\text{V} \leq V_{CC} \leq +6.0\text{V}$
V_{in}^8	$-0.5\text{V} \leq V_{in} \leq V_{CC} + 0.5\text{V}$
Operating Temperature	-40°C to $+85^\circ\text{C}$
Storage Temperature	-65°C to $+125^\circ\text{C}$

- Exceeding any one or combination of these limits may cause permanent damage to this device.
- M/A-COM does not recommend sustained operation near these survivability limits.
- Standard CMOS TTL interface, latch-up will occur if logic signal is applied prior to power supply.

Recommended PCB Configuration⁹

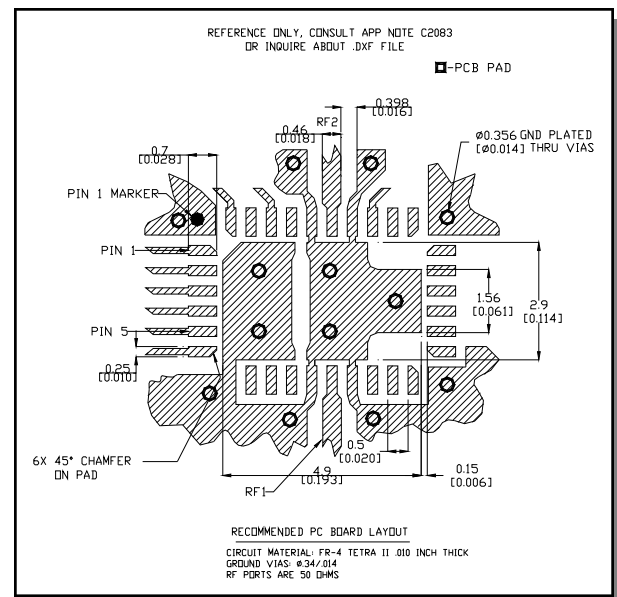

9. Application Note S2083 is available on line at www.macom.com.

Handling Procedures

Please observe the following precautions to avoid damage:

Static Sensitivity

Gallium Arsenide Integrated Circuits are sensitive to electrostatic discharge (ESD) and can be damaged by static electricity. Proper ESD control techniques should be used when handling these devices.

Moisture Sensitivity

The MSL rating for this part is defined as Level 2 per IPC/JEDEC J-STD-020. Parts shall be stored and/or baked as required for MSL Level 2 parts.

Typical Performance Curves

Insertion Loss

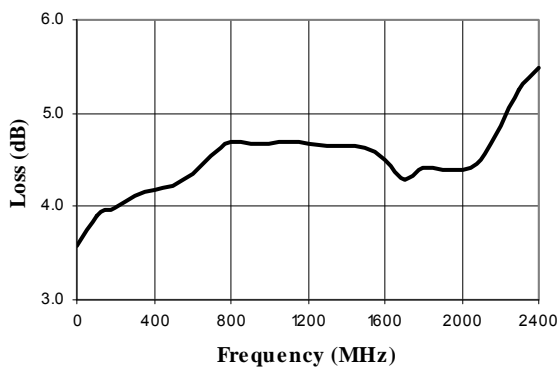

Truth Table (Digital Attenuator)

C32	C16	C8	C4	C2	C1	Attenuation
0	0	0	0	0	0	Loss, Reference
0	0	0	0	0	1	1.0 dB
0	0	0	0	1	0	2.0 dB
0	0	0	1	0	0	4.0 dB
0	0	1	0	0	0	8.0 dB
0	1	0	0	0	0	16.0 dB
1	0	0	0	0	0	32.0 dB
1	1	0	0	1	0	50.0 dB

0 = TTL Low; 1 = TTL High

VSWR @ Insertion Loss

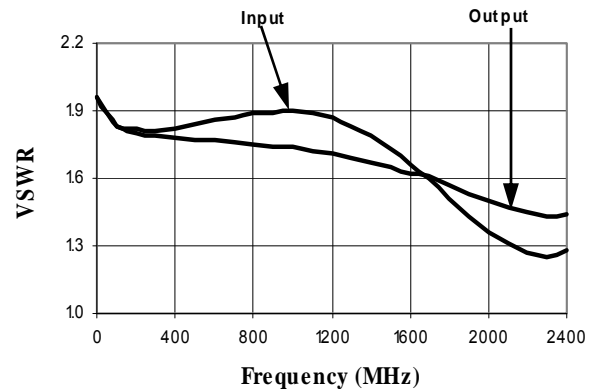

Attenuation Error, 1 dB Bit

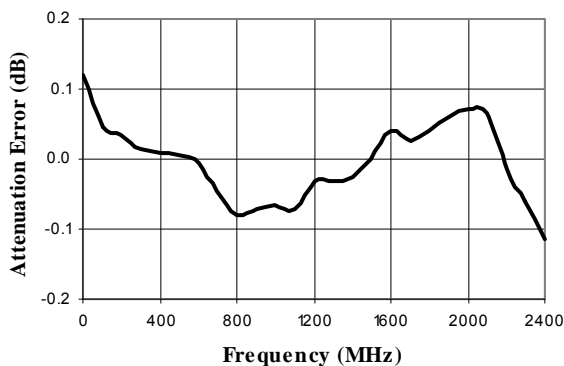

Attenuation Error, 2 dB Bit

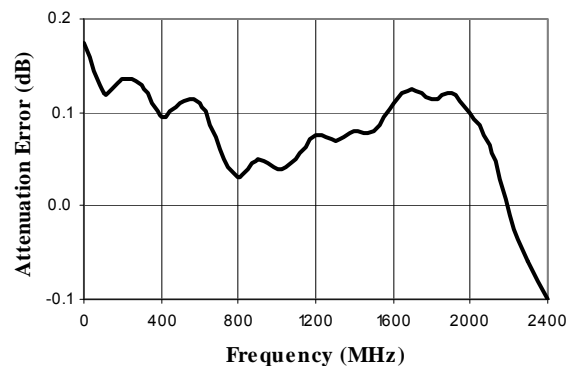

Typical Performance Curves

Attenuation Error, 4 dB Bit

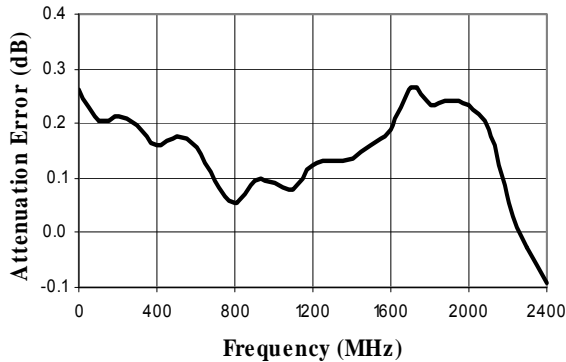

Attenuation Error, 8 dB Bit

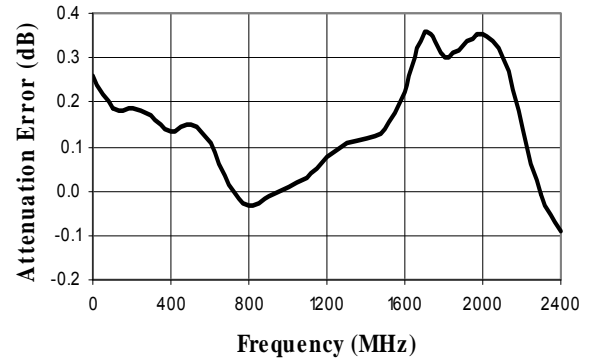

Attenuation Error, 16 dB Bit

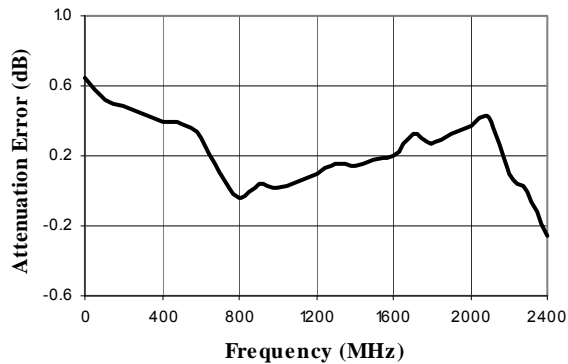

Attenuation Error, 32 dB Bit

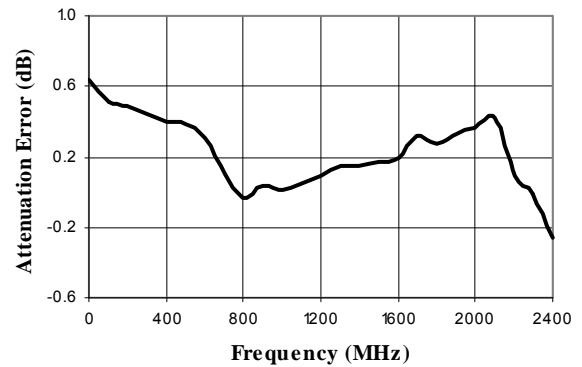

Attenuation Error, Max. Attenuation

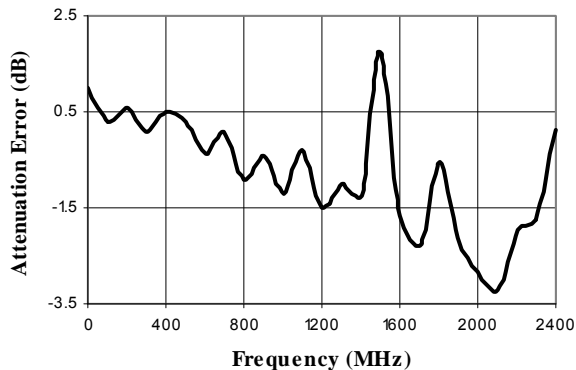

VSWR, 1 dB Bit

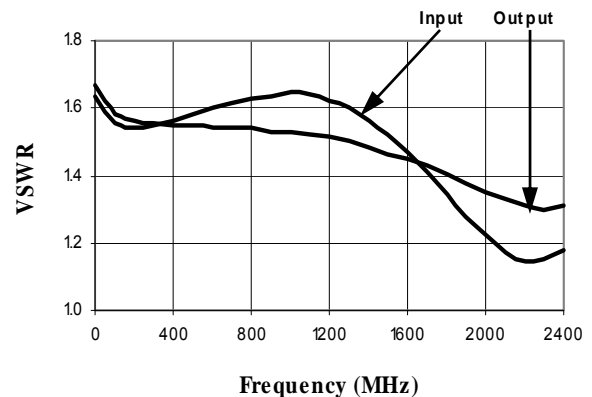

Typical Performance Curves

VSWR, 2 dB Bit

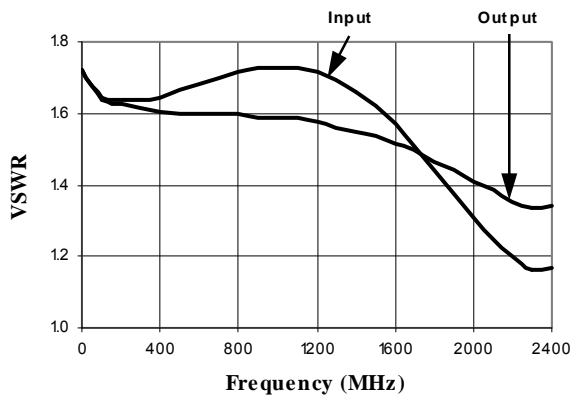

VSWR, 4 dB Bit

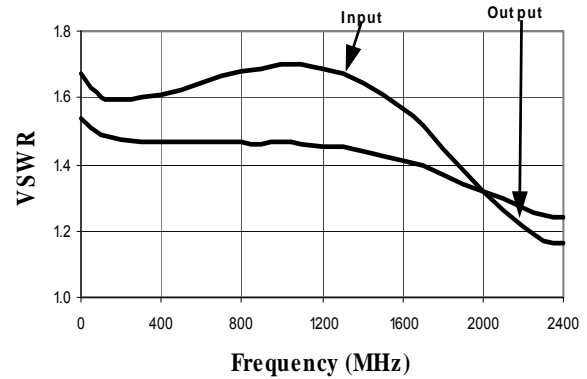

VSWR, 8 dB Bit

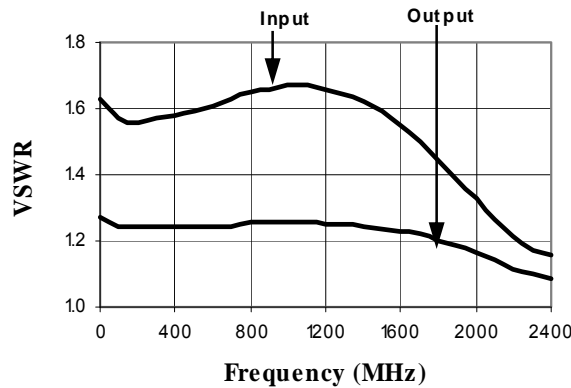

VSWR, 16 dB Bit

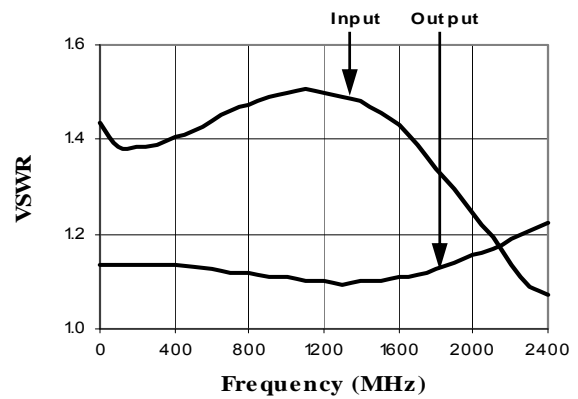

VSWR, 32 dB Bit

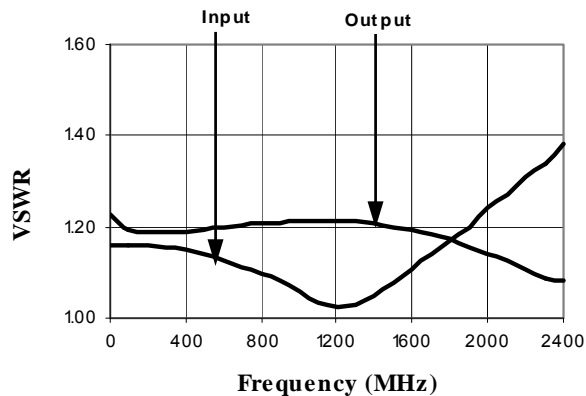

VSWR, Maximum attenuation

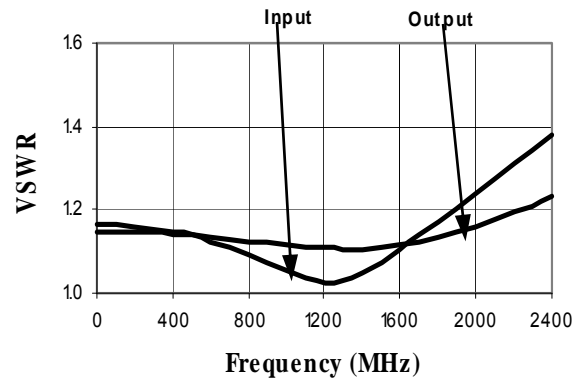

Typical Performance Curves

Maximum IP3 over Temperature Range and Attenuation @ 50 MHz

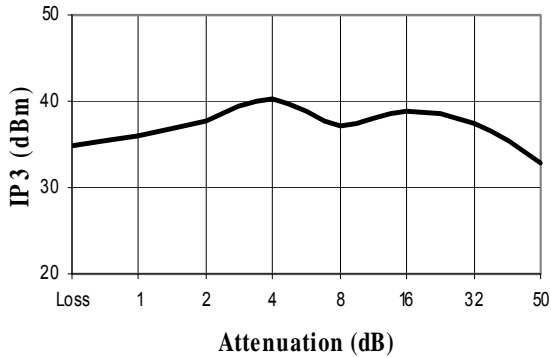

Maximum IP3 over Temperature Range and Attenuation @ 950 MHz

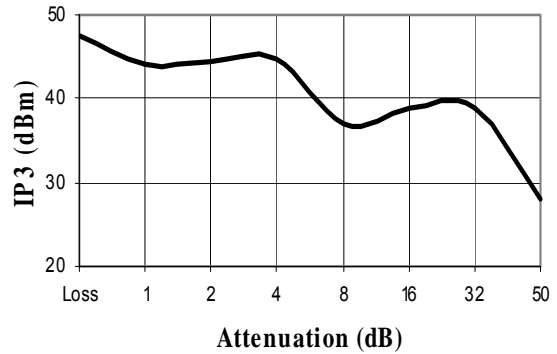

Maximum IP3 over Temperature Range and Attenuation @ 1900 MHz

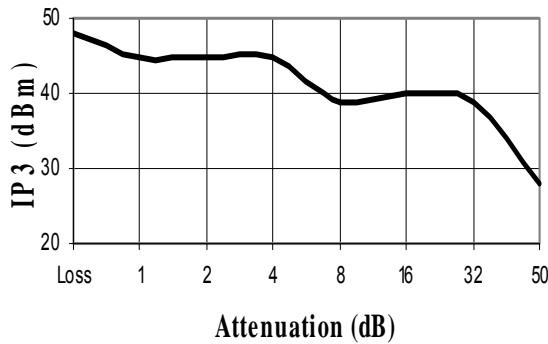

AT90-1106

Digital Attenuator
50.0 dB, 6-Bit, TTL Driver, DC-2.4 GHz

Rev. V13

CSP-1, 4 x 6 mm, 32-lead PQFN[†]

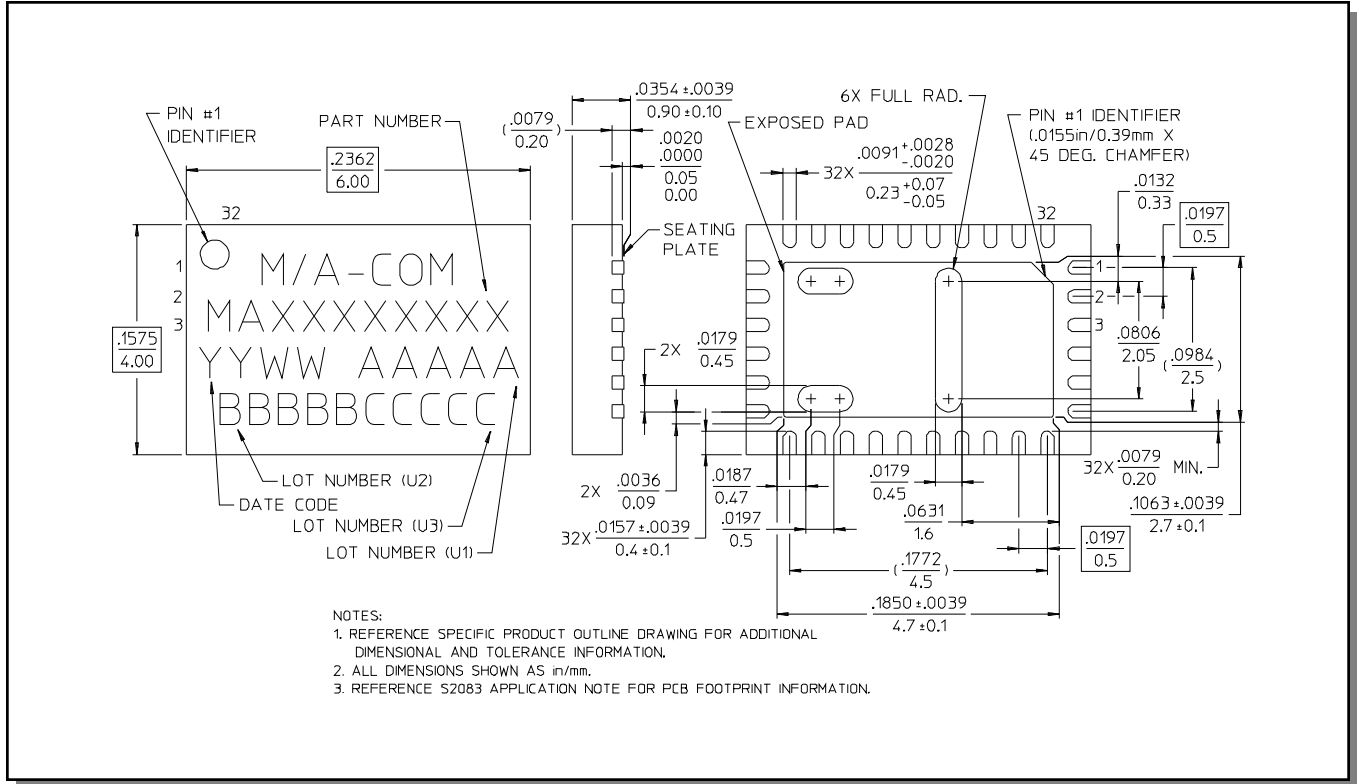

[†] Reference Application Note M538 for lead-free solder reflow recommendations.