



# PRODUCT SPECIFICATION

**Model No : CSM-58271VM9/58281VM9**

## Descriptions:

- 2.3 Inch 5X8 Dot-Matrix Display
- Dot Pitch 7.62mm
- CSM-58271: Column Anode, Row Cathode
- CSM-58281: Column Cathode, Row Anode
- Emitting Color: Super Bright Orange & Super Bright Green



CUSTOMER APPROVED SIGNATURES	APPROVED BY	CHECKED BY	PREPARED BY

**CHINA SEMICONDUCTOR CORPORATION**  
Address:2FL. NO.909,Chung-Cheng Road,  
Chung-Ho City Taipei Hsien,Taiwan.

Tel:886-2-2223-9696  
Fax:886-2-2223-9377

**OPTO PLUS TECHNOLOGIES CO.,LTD**  
Address:696 Shun jiang Rd.,Ji Shan St.Shaoxing,  
ZheJiang,China

Tel:86-0575-8623888  
Fax:86-0575-8623112



Spec. No.	PS-ND-08090409
Rev.	A

**Model No : CSM-58271/58281VM9**

**Features -**

1. 2.3 inch (58.0mm) Matrix height.
2. Case mold type.
3. RoHs compliant.
4. Low power consumption.
5. Easy mounting on P.C. board or socket.

**Device Selection Guide -**

Part No.	Chip		Description	
	Material	Emitted Color	Column	Row
CSM-58271VM9	GaAsP	Orange	Anode	Cathode
	GaP	Yellow Green		
CSM-58281VM9	GaAsP	Orange	Cathode	Anode
	GaP	Yellow Green		

**Package Dimensions -**

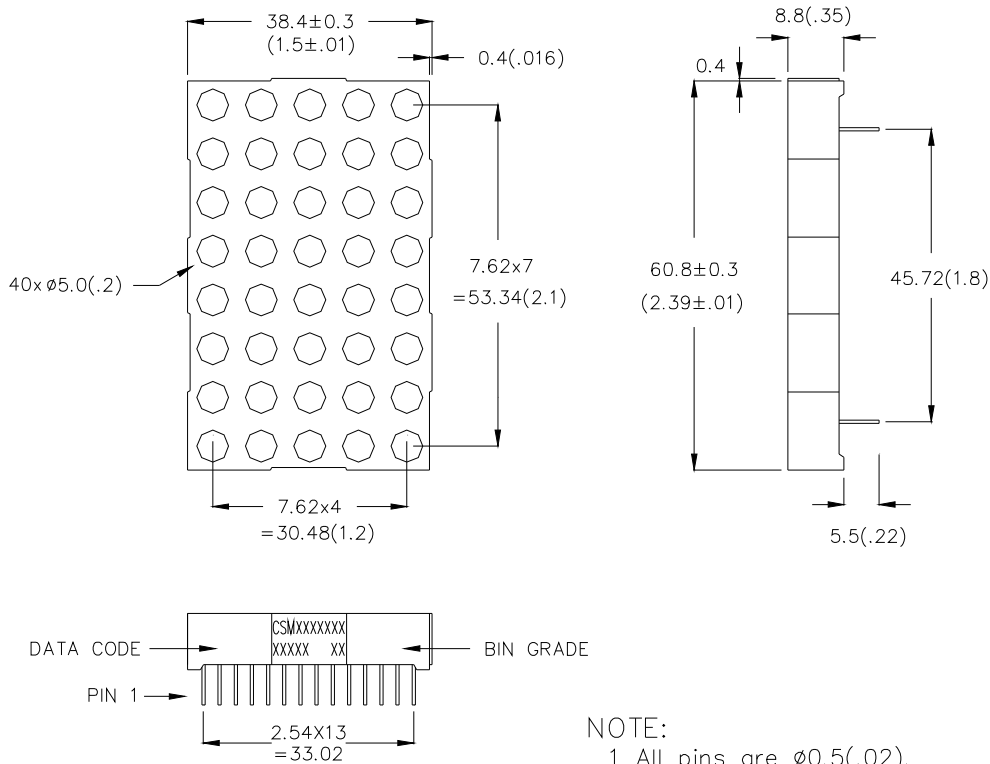

**NOTE:**

- 1 All pins are  $\phi 0.5(.02)$ .
- 2 Dimension in millimeters (inch), tolerance is  $\pm 0.25 (.01)$  unless otherwise noted.



Model No : CSM-58271/58281VM9

Internal Circuit Diagrams -

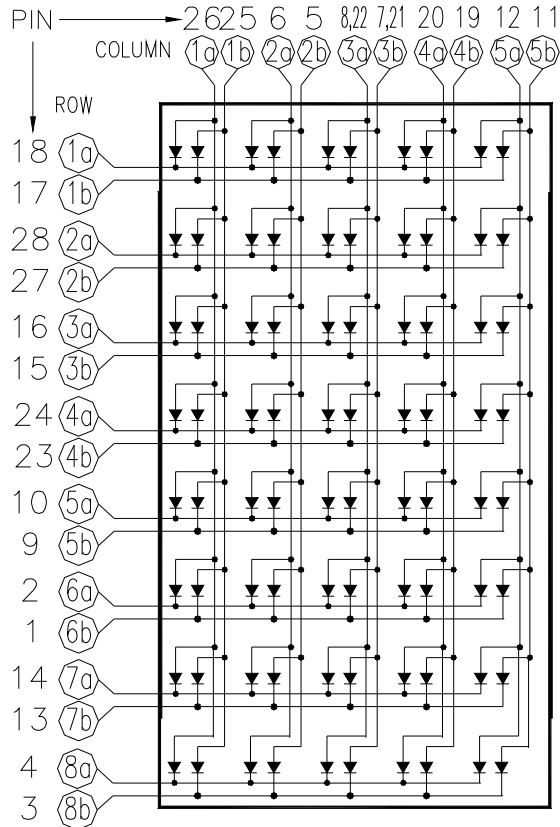

NOTE: "a" for Super Bright Orange color chip.  
"b" for Super Bright Green color chip

CSM-58271. Row Cathode, Column Anode.  
(CSM-58281. Row Anode, Column Cathode.)

Absolute Maximum Rating -

Super Bright Orange		(Ta=25°C)	
Parameter	Symbol	Rating	Unit
Power Dissipation Per Dice	Pd	70	mW
Continuous Forward Current Per Dice	IAF	25	mA
Peak Current Per Dice(duty cycle 1/10, 1kHz)	IPF	90	mA
Derating Linear From 25°C Per Dice	-	0.33	mA/°C
Reverse Voltage Per Dice	VR	5	V
Operating Temp.	Topr	-35 ~ +85	°C
Storage Temp.	Tstg	-35 ~ +85	°C
Solder temperature 1/16 inch below seating plane for 3 seconds at 260°C			



Model No : CSM-58271/58281VM9

Super Bright Green		(Ta=25°C)	
Parameter	Symbol	Rating	Unit
Power Dissipation Per Dice	<b>Pd</b>	70	mW
Continuous Forward Current Per Dice	<b>IAF</b>	25	mA
Peak Current Per Dice(duty cycle 1/10, 1kHz)	<b>IPF</b>	90	mA
Derating Linear From 25°C Per Dice	-	0.33	mA/°C
Reverse Voltage Per Dice	<b>VR</b>	5	V
Operating Temp.	<b>Topr</b>	-35 ~ +85	°C
Storage Temp.	<b>Tstg</b>	-35 ~ +85	°C
Solder temperature 1/16 inch below seating plane for 3 seconds at 260°C			

■ Electro-optical Characteristics -

Super Bright Orange		(Ta=25°C)				
Parameter	Symbol	Min.	Typ.	Max.	Unit	Condition
Forward Voltage Per Segment	<b>VF</b>	-	2.0	2.8	V	IF=20mA
Luminous Intensity Per Segment	<b>Iv</b>	-	40	-	mcd	IF=10mA
Peak Emission Wavelength	$\lambda_p$	-	632	-	nm	IF=20mA
Dominant Wavelength	$\lambda_d$	-	624	-	nm	IF=20mA
Spectrum Radiation Bandwidth	$\Delta \lambda$	-	20	-	nm	IF=20mA
Reverse Current	<b>IR</b>	-	-	100	$\mu A$	VR=5V
Luminous Intensity Matching Ratio	<b>IV-m</b>	-	-	2:1	-	IF=10mA

Super Bright Green		(Ta=25°C)				
Parameter	Symbol	Min.	Typ.	Max.	Unit	Condition
Forward Voltage Per Segment	<b>VF</b>	-	2.1	2.8	V	IF=20mA
Luminous Intensity Per Segment	<b>Iv</b>	-	18	-	mcd	IF=10mA
Peak Emission Wavelength	$\lambda_p$	-	572	-	nm	IF=20mA
Dominant Wavelength	$\lambda_d$	-	570	-	nm	IF=20mA
Spectrum Radiation Bandwidth	$\Delta \lambda$	-	20	-	nm	IF=20mA
Reverse Current	<b>IR</b>	-	-	100	$\mu A$	VR=5V
Luminous Intensity Matching Ratio	<b>IV-m</b>	-	-	2:1	-	IF=10mA



Spec. No.	PS-ND-08090409
Rev.	A

Model No : CSM-58271/58281VM9

### ■ Typical Electrical / Optical Characteristics Curves -Super Bright Orange

(Ta = 25°C Unless Otherwise Noted)

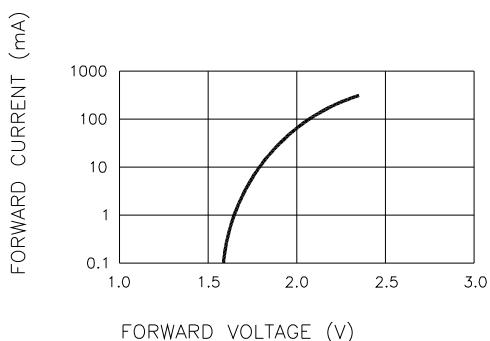

Fig.1 FORWARD CURRENT VS. FORWARD VOLTAGE

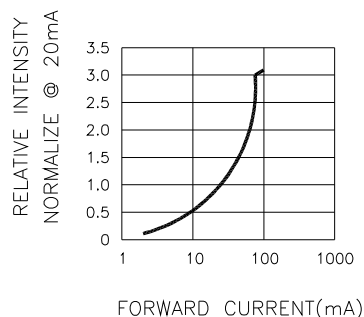

Fig.2 RELATIVE INTENSITY VS. FORWARD CURRENT

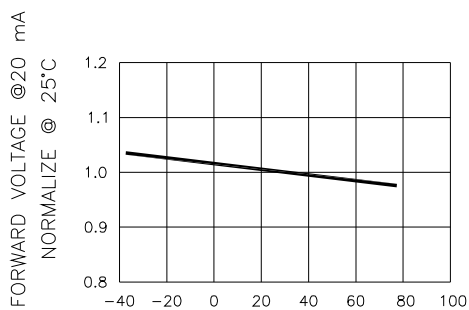

Fig.3 FORWARD VOLTAGE VS. TEMPERATURE

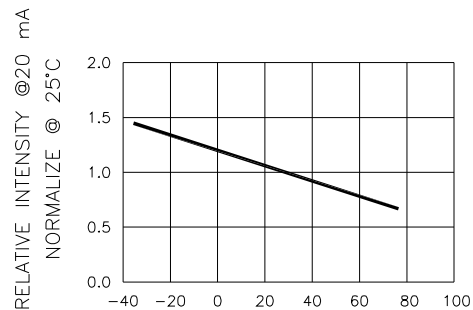

Fig.4 RELATIVE INTENSITY VS. TEMPERATURE

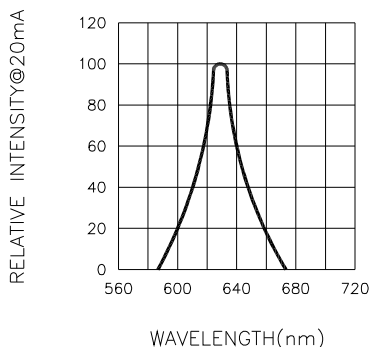

Fig.5 RELATIVE INTENSITY VS. WAVELENGTH



Model No : CSM-58271/58281VM9

■ Super Bright Green

(Ta = 25°C Unless Otherwise Noted)

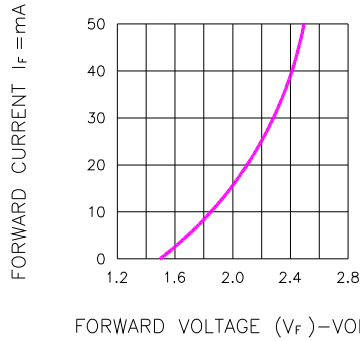

Fig.1 FORWARD CURRENT VS. FORWARD VOLTAGE

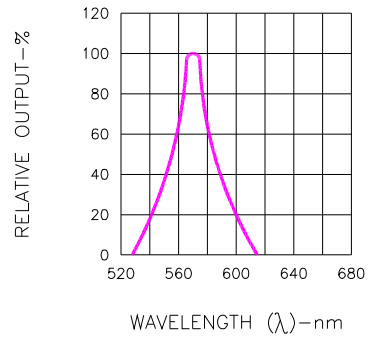

Fig.2 SPECTRAL RESPONSE

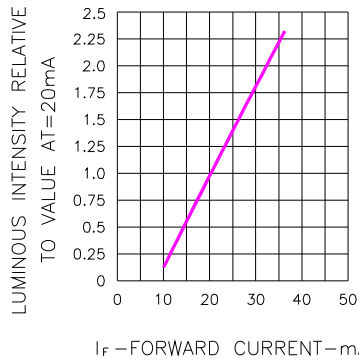

Fig.3 RELATIVE LUMINOUS INTENSITY VS. FORWARD CURRENT

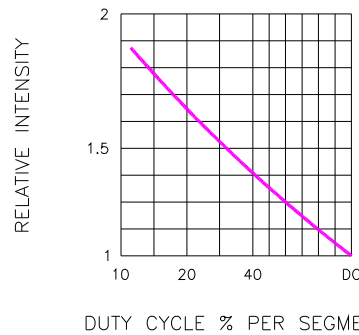

Fig.5 LUMINOUS INTENSITY VS. DUTY CYCLE

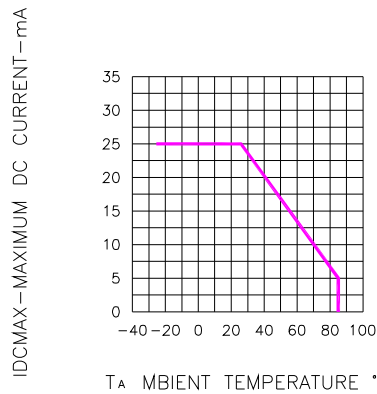

Fig.4 MAXIMUM ALLOWABLE DC CURRENT PER SEGMENT VS. A FUNCTION OF AMBIENT TEMPERATURE

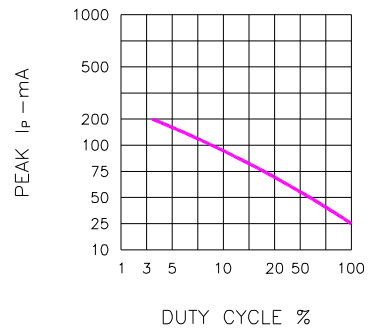

Fig.6 MAX PEAK CURRENT VS. DUTY CYCLE % (REFRESH RATE f=1 KHz)