

185-HMA (06 Plug)

Expanded Beam Fiber Optic Connector

HMA Series: Miniaturized Hermaphroditic

185-HMA-A 06-C-50/125

Product Series
Basic Number
Platform
06 = Plug
Finish (Table II)
Fiber Type

TABLE II: FINISH

SYM	Material	FINISH
C	Aluminum	Anodized, Black
AB	Aluminum	Nickel Aluminum Bronze

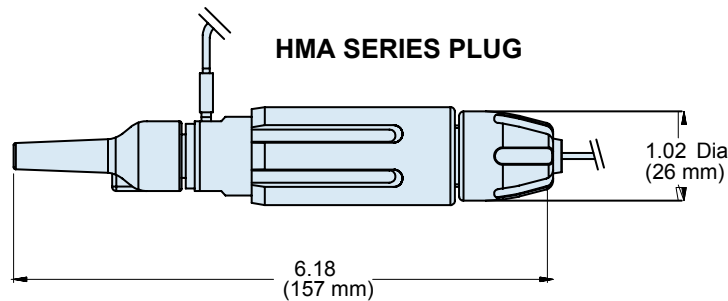

PLATFORMS

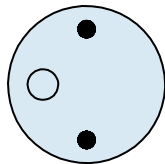

PLATFORM A
1 CHANNEL

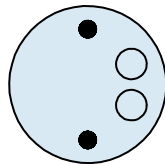

PLATFORM B
2 CHANNEL

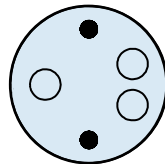

PLATFORM C
3 CHANNEL

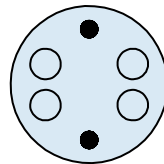

PLATFORM D
4 CHANNEL

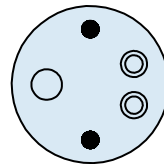

PLATFORM E
Hybrid 1+2

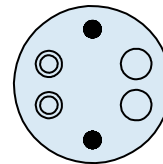

PLATFORM F
Hybrid 2+2

TABLE I: PERFORMANCE

Optical Loss	50/125 @ 850/1300nm 0.6 dB Typical 9/125 @ 13190/1550nm 1.0 dB Typical
Return Loss	9/125 @ 1310/1550nm > 45 dB (Typical 48 dB)
Operating Temperature	-40°C to +70°C
Storage Temperature	-55°C to +85°C
Water Immersion	Up to 2M Depth
Vibration Sinusoidal	10-500Hz, 0.75 Amplitude @ 10g Acceleration
Free Fall Resistance	500 Falls onto Concrete from 1.2M height
Bump Resistance	4,000 Bumps @ 40g Acceleration
Tensile Strength	Tensile of 1,500N, Cable Dependent
Cable Variations	Compatible with Tactical cable: Plug <6mm O/D Bulkhead <3mm O/D Other Cable Sizes Available on request

All Tests Compliant to BS EN 186000-1 Specifications

**PART SUPPLIED ONLY AS
TERMINATED ASSEMBLY**

**CONSULT FACTORY
FOR CABLE DESIGN**