

PLEASE CHECK WWW.MOLEX.COM FOR LATEST PART INFORMATION

Part Number: [0002066143](#)
Status: **Active**
Overview: [standard_062](#)
Description: 1.57mm (.062") Diameter, Standard .062" Pin and Socket Crimp Terminal, Series 1854, Male, with Selective Gold (Au) Plated Brass Contact, Tin (Sn) Plated Crimp Area, 24-30 AWG, Reel

Documents:

[Drawing \(PDF\)](#) [RoHS Certificate of Compliance \(PDF\)](#)

General

Product Family	Crimp Terminals
Series	1854
Crimp Quality Equipment	Yes
Overview	standard_062
Product Name	Standard .062"
Physical	
Gender	Male
Material - Metal	Brass
Material - Plating Mating	Gold
Material - Plating Termination	Tin
Packaging Type	Reel
Plating min: Mating (µin)	30
Plating min: Mating (µm)	0.75
Plating min: Termination (µin)	100
Plating min: Termination (µm)	2.5
Termination Interface: Style	Crimp or Compression
Wire Insulation Diameter	1.02-2.29mm (.040-.090")
Wire Size AWG	24, 26, 28, 30
Wire Size mm ²	N/A

Material Info

Old Part Number 1854-(228)

Reference - Drawing Numbers

Sales Drawing SD-1854-*

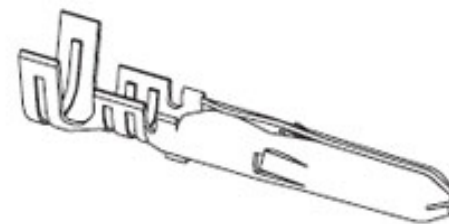

Series

image - Reference only

EU RoHS

**ELV and RoHS
Compliant**
**REACH SVHC
Not Reviewed**
**Halogen-Free
Status**

China RoHS



Not Reviewed

**Need more information on product
environmental compliance?**

Email productcompliance@molex.com
 For a multiple part number RoHS Certificate of Compliance, [click here](#)

Please visit the [Contact Us](#) section for any non-product compliance questions.

Search Parts in this Series

[1854Series](#)

Application Tooling | [FAQ](#)

Tooling specifications and manuals are found by selecting the products below. Crimp Height Specifications are then contained in the Application Tooling Specification document.

Global

Description	Product #
Mini-Mac™ Applicator	0638914100
Hand Crimp Tool	0638190800
Manual Extraction Tool	0011030002
Terminator Die	0011402006
Hand Crimper - DISTRIBUTION ONLY	0638111000

Japan

Description	Product #
Hand Insertion Tool	0011020001

This document was generated on 05/17/2010

PLEASE CHECK WWW.MOLEX.COM FOR LATEST PART INFORMATION

PART NO.	ENG. NO.	
02-06-2131	1854-(901)	
02-06-2132	1854-(901)L	
02-06-2134	1854-(901)1	OBSOLETE
02-06-6137	1854-(591)	
02-06-6136	1854-(591)L	
02-06-6138	1854-(561)	
02-06-6139	1854-(561)L	
02-06-6130	1854-(550)	
02-06-6135	1854-(550)L	
02-06-6143	1854-(228)	
02-06-6144	1854-(228)L	
02-06-6145	1854-(603)1	OBSOLETE

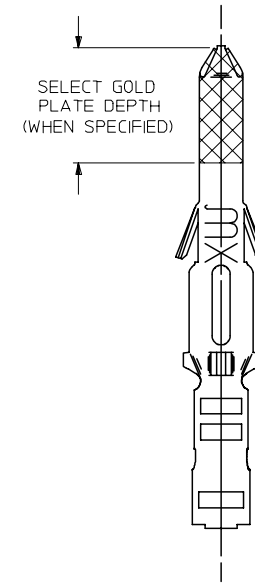
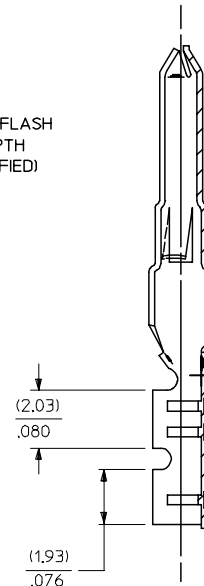
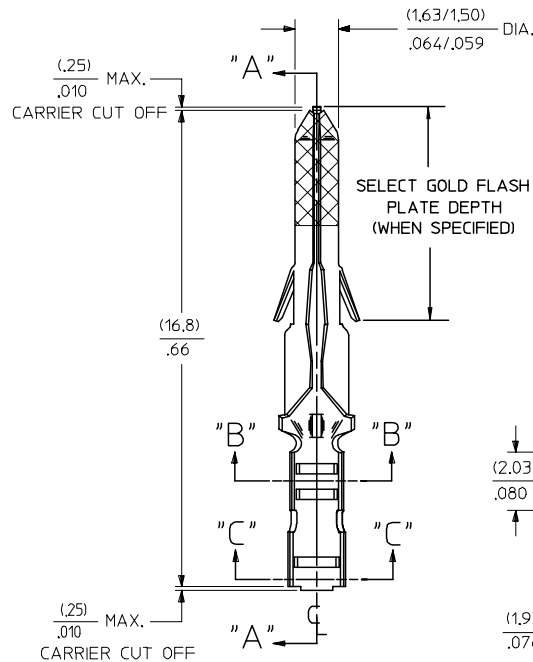
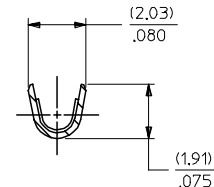
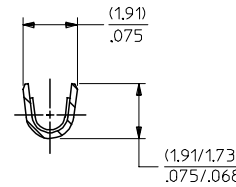
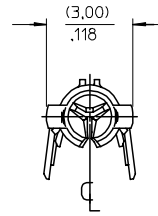
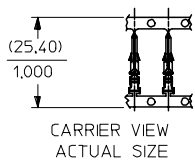

SECT. "A-A"

LEGEND

1854-(****)*

- P=PREPLATE
- BLANK=POSTPLATE
- FINISH CODE
- FORM BLANK=CHAIN
- 1=CHAIN WITH INTERLEAF PAPER ON REEL.
- L=LOOSE

NOTES:

1. MATERIAL: BRASS
2. FINISHES:
 - 901 HOT TIN DIP (.00051)/.000020 MIN.
 - * 228 SELECT GOLD PLATE (.00075)/.000030 MIN. IN CONTACT AREA, SELECT TIN (.00250)/.000100 MIN. IN CRIMP AREA OVER (.00125)/.000050 MIN. NICKEL OVERALL, WITH (.000010)/.000025 MAX. SELECT GOLD FLASH AS INDICATED.
 - 561 SELECT GOLD PLATE (.00076)/.000030 MIN. IN CONTACT AREA, (.00127)/.000050 MIN. NICKEL OVERALL.
 - 591 SELECT GOLD PLATE (.00127)/.000050 MIN. IN CONTACT AREA, OVER (.00127)/.000050 MIN. NICKEL OVERALL WITH (.00025)/.000010 MAX. GOLD FLASH OVERALL.
 - 550 SELECT GOLD PLATE (.00038)/.000015 MIN. IN CONTACT AREA, OVER (.00076)/.000030 MIN. NICKEL OVERALL WITH (.00025)/.000010 MAX. GOLD FLASH OVERALL.
- * THE PRIMARY SHIPPING CARTON WILL BE LABELED, "COMPLIANT TO RoHS DIRECTIVE 2002/95/EC AND ELV ANNEX II OF DIRECTIVE 2000/53/EC", CARTONS WITHOUT THIS LABEL MAY CONTAIN PRODUCT WITH TIN-LEAD.
3. PRODUCT SPECIFICATIONS: PS-02-06
4. PACKAGING INFORMATION: NOT AVAILABLE
5. TERMINAL FOR USE WITH (1.57)/.062 DIA. SERIES HOUSINGS AND WILL ACCEPT 24 THRU 30 AWG. WIRE WITH (1.02/2.29)/.040/0.090 INSULATION DIA.

WORK AREA

SEE REVISION BLOCK FOR LOT
 EC NO: UPRC2004-2097
 DRAWN/RHOLTS 04/27/2004
 CHKD:
 APPR:

QUALITY SYMBOLS	GENERAL TOLERANCES (UNLESS SPECIFIED)		SCALE 8:1	DESIGN UNITS INCH	THIRD ANGLE PROJECTION	REVISE ON CAD ONLY
	4 PLACES	± .010	± .010	INCH		
▽ = 0	3 PLACES	± .010	± .010	DIMENSION STYLE INCH/MM	TITLE	CRIMP TERMINAL, MALE (1.57)/.062 DIA., BRASS FOR 24 THRU 30 GA. WIRE
	2 PLACES	± .025	± .035	DRAWN BY GEP DATE 9/27/87		
▽ = 0	1 PLACE	± .035	± .035	CHECKED BY RW DATE 9/27/87	MATERIAL NO. SEE CHART	DOCUMENT NO. SD-1854*
	ANGULAR ± 1/2°		DRAFT WHERE APPLICABLE MUST REMAIN WITHIN DIMENSIONS			
AP	REV	THIS DRAWING CONTAINS INFORMATION THAT IS PROPRIETARY TO MOLEX INCORPORATED AND SHOULD NOT BE USED WITHOUT WRITTEN PERMISSION				

AP	REMV Sn/Pb PLATING REDRAWN TO ME10 UCP2004-2097 RHOLTS 5/07/04
AN	OBSOLETE P/N UCR2002-0270 COMERC 01/9/27
AM2	OBSOLETE -675 & -675L ECR U6 0358 9/15/95 RW
AM1	ADD -(603)1 PER ERO #30605 11-5-90 RW
AM	REV. & REDRAWN PER ECR 10372 GEP 9-21-87 RW