

PROTECTION PRODUCTS - EMIClamp™

Description

The EClamp™2342N is a low pass filter array with integrated TVS diodes. It is designed to suppress unwanted EMI/RFI signals and provide electrostatic discharge (ESD) protection in portable electronic equipment. This state-of-the-art device utilizes solid-state silicon-avalanche technology for superior clamping performance and DC electrical characteristics. They have been optimized for **protection of color LCD panels** in cellular phones and other portable electronics.

The device consists of eight identical circuits comprised of TVS diodes for ESD protection, and a resistor - capacitor network for EMI/RFI filtering. A series resistor value of 100Ω and a capacitance value of 20pF are used to achieve 30dB minimum attenuation from 1GHz to 2.5GHz. Each line features two stages of TVS diode protection. The TVS diodes provide effective suppression of ESD voltages in excess of 15kV (air discharge) and 8kV (contact discharge) per IEC 61000-4-2, level 4.

The EClamp2342N is in a 16-pin, 0.5mm pitch QFN package. It measures 3.0 x 3.0 x 1.0mm. The small package makes it ideal for use in portable electronics such as cell phones, digital still cameras, and PDA's.

Features

- ◆ Bidirectional EMI/RFI filter with integrated TVS for ESD protection
- ◆ ESD protection to **IEC 61000-4-2 (ESD) Level4, +/-15kV (air), +/-8kV (contact)**
- ◆ Filter performance: 30dB minimum attenuation 1GHz to 2.5GHz
- ◆ TVS working voltage: 5V
- ◆ Resistor: 100Ω +/- 15%
- ◆ Input Capacitance: 20pF (VR = 0V)
- ◆ Protection and filtering for eight lines
- ◆ Solid-state technology

Mechanical Characteristics

- ◆ 16 pin QFN
- ◆ Nominal Dimensions: 3.0 x 3.0 x 1.0 mm
- ◆ Lead Pitch: 0.5mm
- ◆ Lead finish: Matte Tin
- ◆ Marking : Marking Code + Date Code
- ◆ Packaging : Tape and Reel per EIA 481

Applications

- ◆ Color LCD Panel Protection
- ◆ Cell Phone CCD Camera Lines
- ◆ Clamshell Cell Phones
- ◆ Personal Digital Assistants (PDA's)

Circuit Diagram

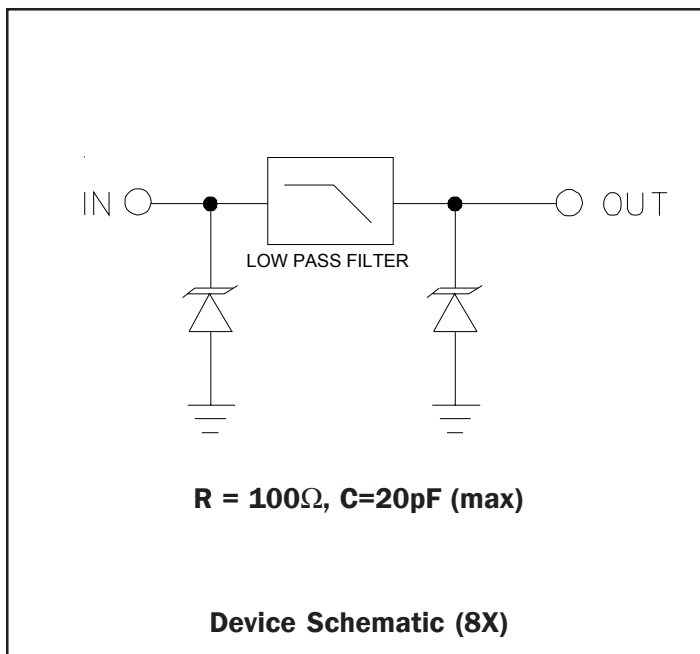

Package Configuration

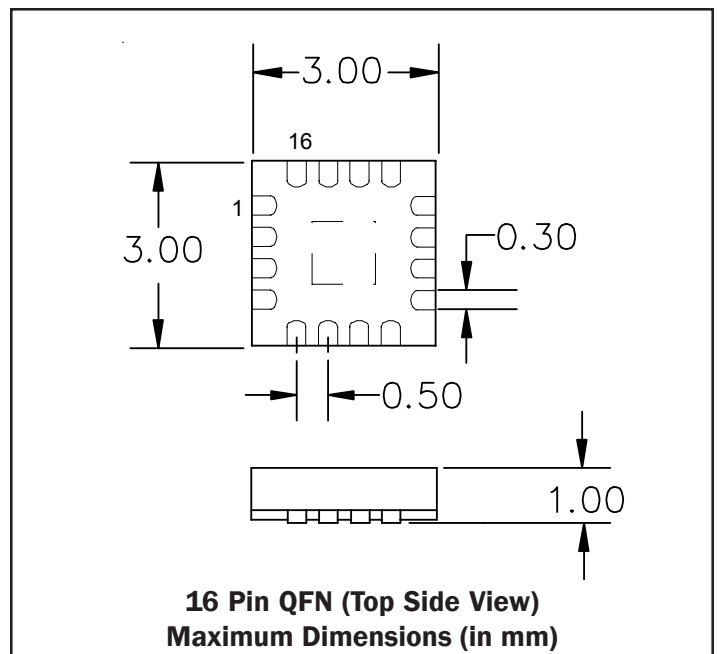

PROTECTION PRODUCTS

Maximum Ratings

Rating	Symbol	Value	Units
ESD per IEC 61000-4-2 (Air) ESD per IEC 61000-4-2 (Contact)	V_{ESD}	+/- 17 +/- 12	kV
Junction Temperature	T_J	125	°C
Operating Temperature	T_{op}	-40 to +85	°C
Storage Temperature	T_{STG}	-55 to +150	°C

Electrical Characteristics

Parameter	Symbol	Conditions	Minimum	Typical	Maximum	Units
TVS Reverse Stand-Off Voltage	V_{RWM}				5	V
TVS Reverse Breakdown Voltage	V_{BR}	$I_t = 1mA$	6	8	10	V
TVS Reverse Leakage Current	I_R	$V_{RWM} = 3.0V$			0.5	μA
Total Series Resistance	R	Each Line	85	100	115	Ohms
Total Capacitance	C_{in}	Input to Gnd, Each Line $V_R = 0V, f = 1MHz$		16	20	pF
Total Capacitance	C_{in}	Input to Gnd, Each Line $V_R = 2.5V, f = 1MHz$		12		pF

PROTECTION PRODUCTS

Typical Characteristics

Typical Insertion Loss S21 (Each Line)

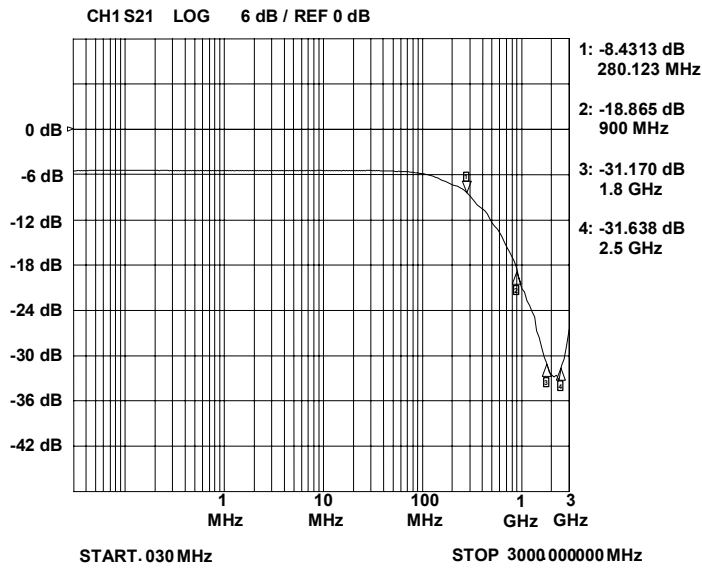

Analog Crosstalk (Each Line)

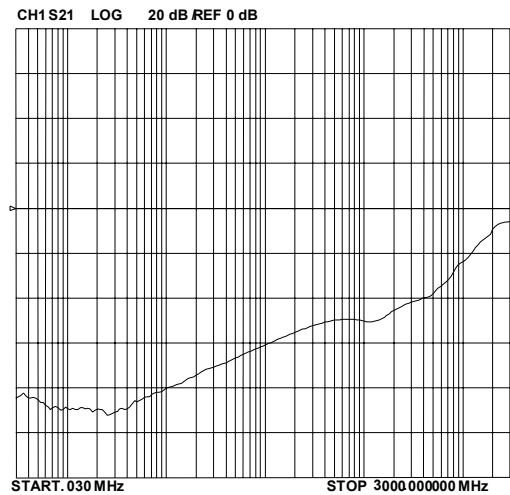

ESD Clamping (+8kV Contact)

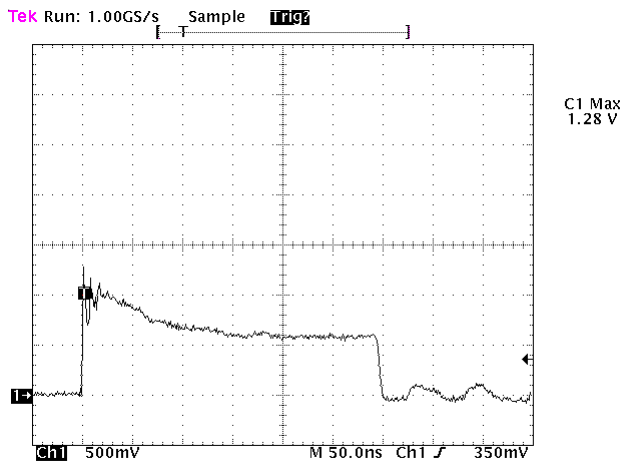

ESD Clamping (-8kV Contact)

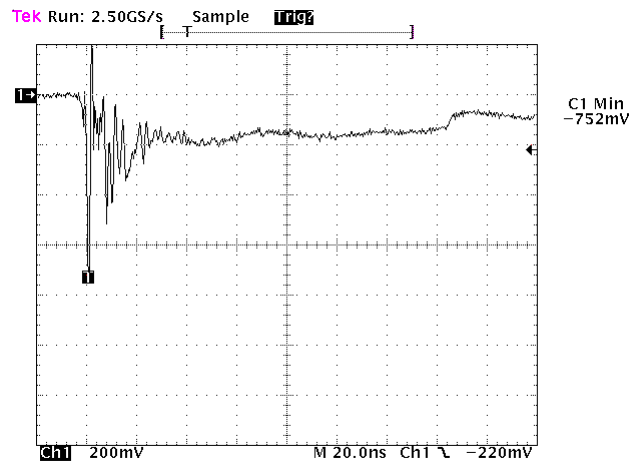

**Capacitance vs. Reverse Voltage
(Normalized to 0 volts)**

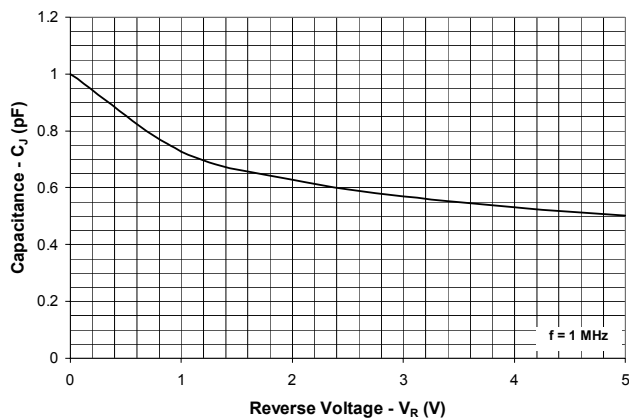

**Series Resistance vs. Temperature
(Normalized to 25 Degrees Celcius)**

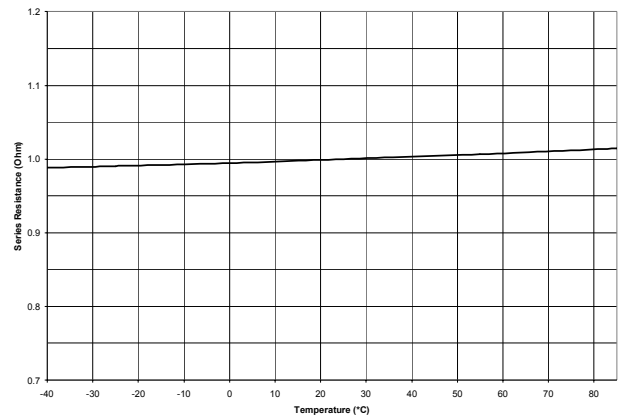

PROTECTION PRODUCTS

Applications Information

Device Connection

The EClamp2342N is comprised of eight identical circuits each consisting of a low pass filter for EMI/RFI suppression and dual TVS diodes for ESD protection. The device is housed in a 16-pin Quad Flat No-Lead (QFN) package. Electrical connection is made via 16 pins located at the bottom of the device. A center tab serves as the ground connection. Pin connections are noted in the table to the right. The device is symmetrical and designed for easy PCB routing as shown in the layout example below. All path lengths should be kept as short as possible to minimize the effects of parasitic inductance in the board traces.

Matte Tin Lead Finish

Matte tin has become the industry standard lead-free replacement for SnPb lead finishes. A matte tin finish is composed of 100% tin solder with large grains. Since the solder volume on the leads is small compared to the solder paste volume that is placed on the land pattern of the PCB, the reflow profile will be determined by the requirements of the solder paste. Therefore, these devices are compatible with both lead-free and SnPb assembly techniques. In addition, unlike other lead-free compositions, matte tin does not have any added alloys that can cause degradation of the solder joint.

Layout Example (Top Side View)

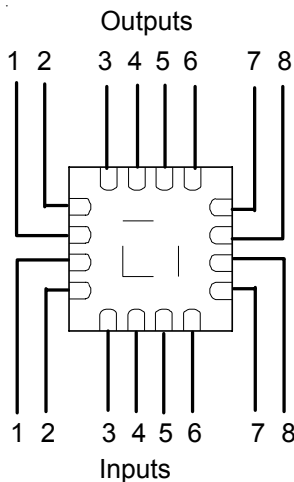

Pin Identification and Configuration (Top Side View)

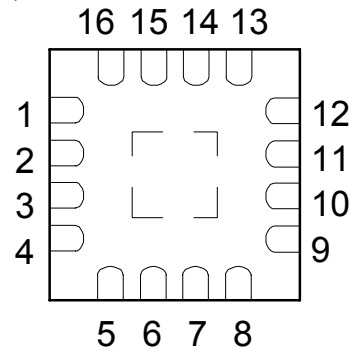

Pin	Identification
3 - 10	Input, Lines 1, 2, 3, 4, 5, 6, 7, 8
1, 2, 11 - 16	Output Lines 1, 2, 3, 4, 5, 6, 7, 8
Center Tab	Ground

Pin Configuration and Schematic

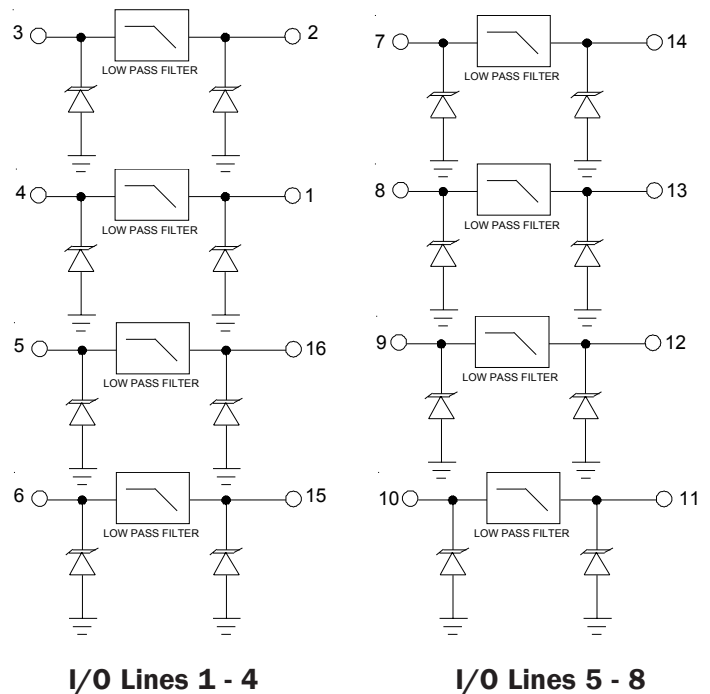

PROTECTION PRODUCTS

Outline Drawing - 16L QFN

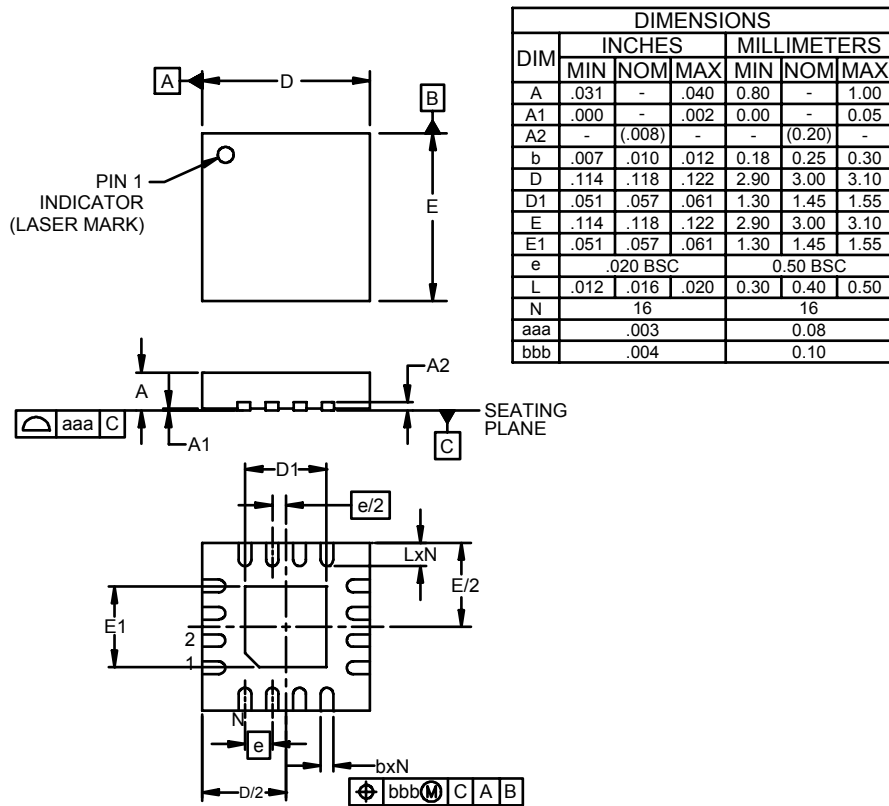

- NOTES:
1. CONTROLLING DIMENSIONS ARE IN MILLIMETERS (ANGLES IN DEGREES).
 2. COPLANARITY APPLIES TO THE EXPOSED PAD AS WELL AS THE TERMINALS.

Land Pattern - 16L QFN

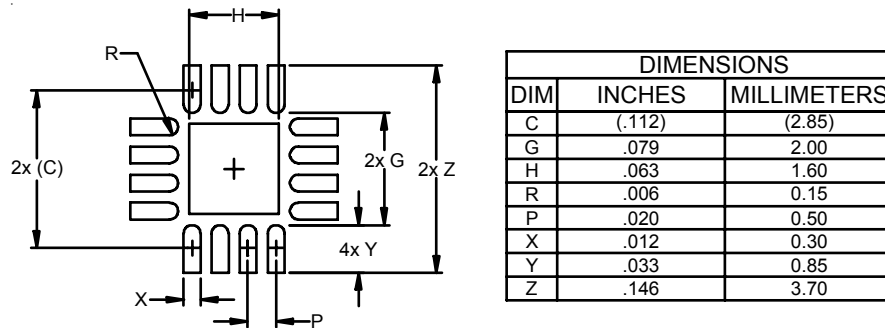

- NOTES:
1. THIS LAND PATTERN IS FOR REFERENCE PURPOSES ONLY. CONSULT YOUR MANUFACTURING GROUP TO ENSURE YOUR COMPANY'S MANUFACTURING GUIDELINES ARE MET.

PROTECTION PRODUCTS

Marking

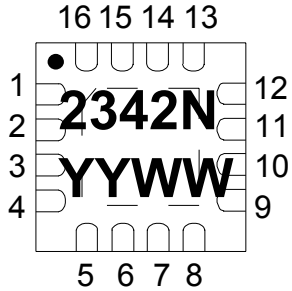

Top View Showing Device Marking

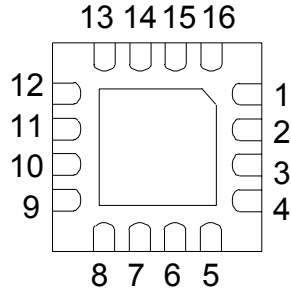

Bottom View Showing Pin 1 Identifier

Ordering Information

Part Number	Qty per Reel	Reel Size
EClamp2342N.TCT	3000	7 Inch

EMIClamp and EClamp are marks of Semtech Corporation

Notes:

- 1) YYWW = Date Code (example: 0410 = 2004 year Week 10)
- 2) Pin 1 indicated by bevel on the ground pad

Tape and Reel Specification

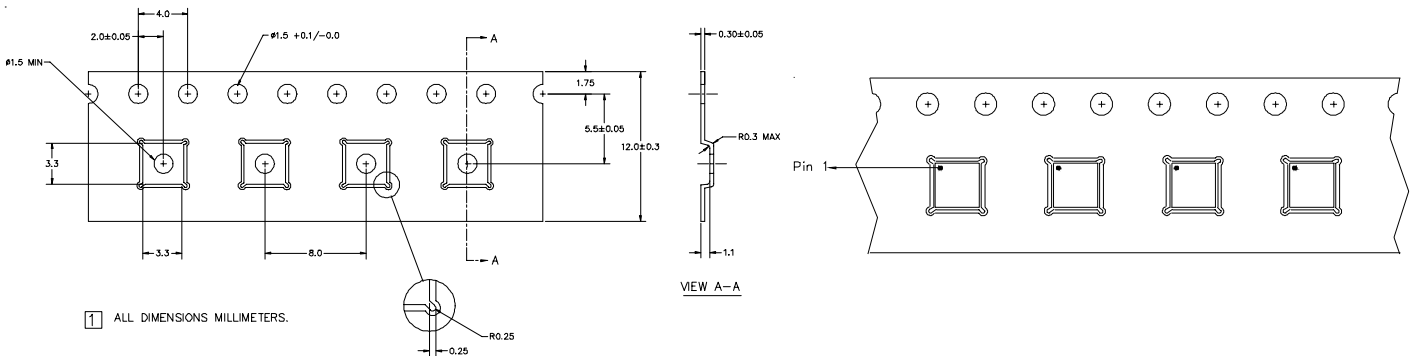

Tape Specifications

Device Orientation in Tape

Contact Information

Semtech Corporation
 Protection Products Division
 200 Flynn Rd., Camarillo, CA 93012
 Phone: (805)498-2111 FAX (805)498-3804