

PLEASE CHECK WWW.MOLEX.COM FOR LATEST PART INFORMATION

Part Number: [0353280460](#)
Status: **Active**
Description: 7.92mm (.312") Pitch Header, Vertical, Positive Lock, Shrouded, 4 Circuits, White, PA Polyamide (Nylon) 6/6, Glass-filled

Documents:

[3D Model](#) [Product Specification PS-35156-005 \(PDF\)](#)
[Drawing \(PDF\)](#) [RoHS Certificate of Compliance \(PDF\)](#)

Agency Certification

CSA	LR19980
TUV	R72081037
UL	E29179

General

Product Family	PCB Headers
Series	35328
Application	Wire-to-Board
Product Name	N/A

Physical

Breakaway	No
Circuits (Loaded)	4
Circuits (maximum)	4
Color - Resin	Natural
Durability (mating cycles max)	30
First Mate / Last Break	No
Flammability	94V-0
Glow-Wire Compliant	No
Guide to Mating Part	No
Keying to Mating Part	None
Lock to Mating Part	Yes
Material - Plating Mating	Tin
Material - Plating Termination	Tin
Material - Resin	Nylon
Number of Rows	1
Orientation	Vertical
PC Tail Length (in)	0.134 In
PC Tail Length (mm)	3.40 mm
PCB Locator	No
PCB Retention	None
PCB Thickness Recommended (in)	0.062 In
PCB Thickness Recommended (mm)	1.60 mm
Packaging Type	Bag
Pitch - Mating Interface (in)	0.312 In
Pitch - Mating Interface (mm)	7.92 mm
Plating min: Mating (µin)	200
Plating min: Mating (µm)	5
Plating min: Termination (µin)	200
Plating min: Termination (µm)	5
Polarized to Mating Part	Yes
Polarized to PCB	No
Shrouded	Partial
Stackable	No
Surface Mount Compatible (SMC)	Yes
Temperature Range - Operating	-40°C to +105°C

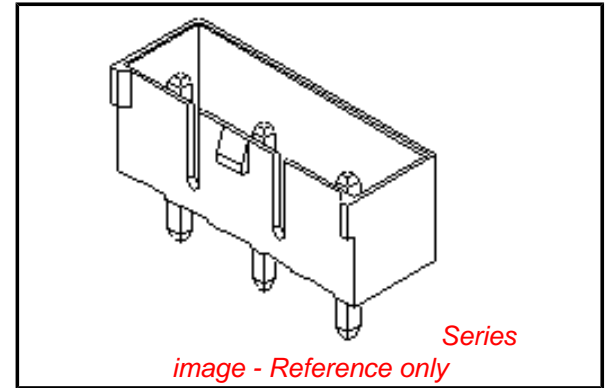

EU RoHS

ELV and RoHS Compliant
REACH SVHC
 Not Reviewed
Halogen-Free Status

China RoHS



Not Halogen-Free

Need more information on product environmental compliance?

Email productcompliance@molex.com
 For a multiple part number RoHS Certificate of Compliance, [click here](#)

Please visit the [Contact Us](#) section for any non-product compliance questions.

Search Parts in this Series

[35328Series](#)

Mates With

[35156 Wire-to-Board Housing](#)

Termination Interface: Style

Through Hole

Electrical

Current - Maximum per Contact

7A

Voltage - Maximum

250V

Material Info

Reference - Drawing Numbers

Product Specification

PS-35156-005

Sales Drawing

SD-35328-001

This document was generated on 04/15/2010

PLEASE CHECK WWW.MOLEX.COM FOR LATEST PART INFORMATION

DWG. NO. SD-35328-001
 SIMILAR ITEM 35328-**-**x
 PROJECT NO.
 DO NOT SCALE DRAWING DIMENSION IN METRIC

8 7 6 5 4 3 2 1

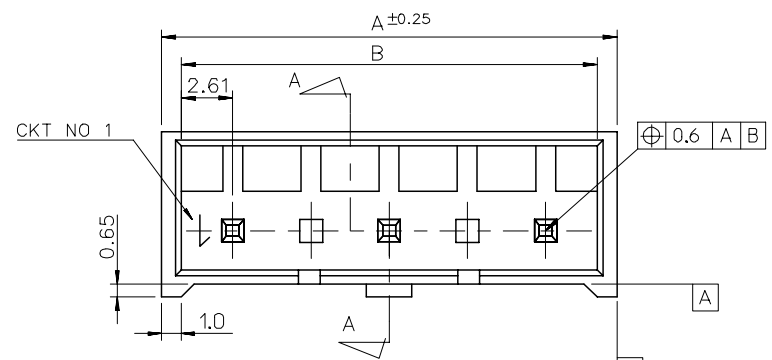

NOTE
 1. MATERIAL : WAFER : NYLON66, GLASS FILLED 20%
 PIN : BRASS, TIN PLATED
 2. LEGEND
 35328-**-** 6 *
 COLOR : 0 - NATURAL
 1 - BLACK
 2 - RED
 3 - YELLOW
 4 - BLUE
 CKT NO.(02,03,04...)
 3. THIS PRODUCT SHALL BE COMPLIED WITH
 RoHS COMPATIBLE(LEAD FREE SOLDERABILITY)

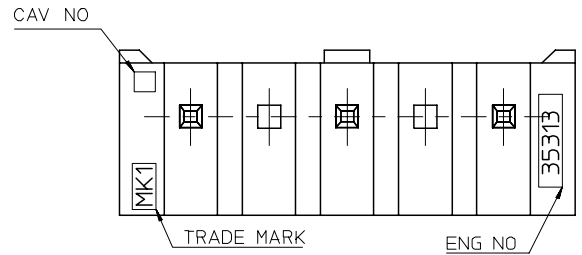
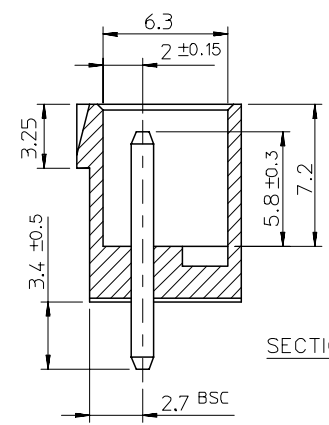
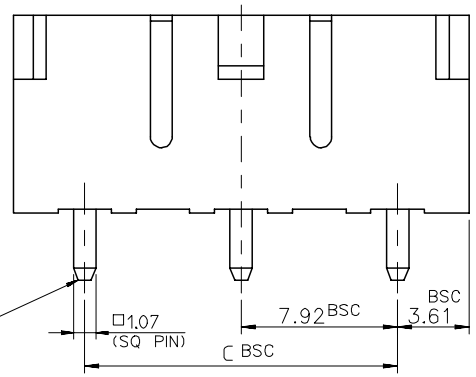
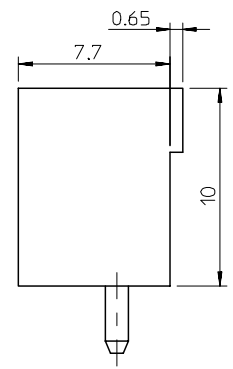

39.6	44.82	46.82	35328066*	35328-066*	6
31.68	36.9	38.9	35328056*	-056*	5
23.76	28.98	30.98	35328046*	-046*	4
15.84	21.06	23.06	35328036*	-036*	3
7.92	13.14	15.14	35328026*	35328-026*	2
C	B	A	MAT'L NO.	ENG NO.	CKT NO.

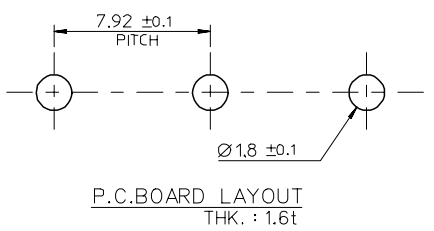

REVISED EC NO. KOR2006-0105 DRWN: K.SKIM 06/03/23 CHK: K.SKIM APPR: Y.SOOKIM	QUALITY SYMBOLS MAJOR CRITICAL	GENERAL TOLERANCES: (UNLESS SPECIFIED)		SCALE 3.5-1	DESIGN UNITS <input checked="" type="checkbox"/> MM <input type="checkbox"/> INCH	THIRD ANGLE PROJECTION	DIMENSIONS: <input type="checkbox"/> MM <input type="checkbox"/> INCH <input type="checkbox"/> MM <input checked="" type="checkbox"/> MM ONLY	SHT REV
		4 PLACES ±0. ±. 3 PLACES ±0. ±. 2 PLACES ±0.2 ±. 1 PLACE ±0.2 ±. ANGULAR: ± 2 °	DRAWN BY & DATE K.S.KIM (041228)	TITLE: 7.92 PITCH W/B CONN. WAFER ASS'Y (WITH LOCK)			APPROVED BY & DATE S.H.CHOI	MATERIAL NO. SEE TABLE
C	REV	DRAFT WHERE APPLICABLE MUST REMAIN WITHIN DIMENSIONS		THIS DRAWING CONTAINS INFORMATION THAT IS PROPRIETARY TO MOLEX INCORPORATED AND SHOULD NOT BE USED WITHOUT WRITTEN PERMISSION.				SIZE B

8 7 6 5 4 3 2 1

F
 E
 D
 C
 B
 A
 MX-A3