

HiPerFET™ Power MOSFET

in ECO-PAC 2

PSMG 50/05*

(Electrically Isolated Back Surface)
Single MOSFET Die

I_{D25} = 43 A
 V_{DSS} = 500 V
 R_{DSon} = 100 mΩ
 t_{rr} < 250 ns

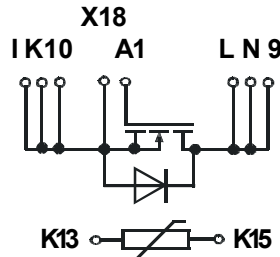

*NTC optional



Preliminary Data Sheet

MOSFET

Symbol	Conditions	Maximum Ratings	
V_{DSS}	$T_{VJ} = 25^{\circ}\text{C}$ to 150°C	500	V
V_{GS}		±20	V
I_{D25}	$T_C = 25^{\circ}\text{C}$	43	A
I_{D90}	$T_C = 90^{\circ}\text{C}$	tbd	A
dv/dt	$V_{DS} < V_{DSS}$; $I_F \leq 50\text{A}$; $ di_F/dt \leq 100\text{A}/\mu\text{s}$ $T_{VJ} = 150^{\circ}\text{C}$	5	V/ns
E_{AS}	$I_D = 10\text{A}$; $L = 36\text{mH}$; $T_C = 25^{\circ}\text{C}$	3	J
E_{AR}	$I_D = 20\text{A}$; $L = 5\mu\text{H}$; $T_C = 25^{\circ}\text{C}$	60	mJ

Features

- ECO-PAC 2 with DCB Base
 - Electrical isolation towards the heatsink
 - Low coupling capacitance to the heatsink for reduced EMI
 - High power dissipation
 - High temperature cycling capability of chip on DCB
 - solderable pins for DCB mounting
- fast CoolMOS power MOSFET
 - 2nd generation
 - High blocking capability
 - Low on resistance
 - Avalanche rated for unclamped inductive switching (UIS)
 - Low thermal resistance due to reduced chip thickness
- Enhanced total power density
- UL certified, E 148688

Symbol	Conditions	Characteristic Values ($T_{VJ} = 25^{\circ}\text{C}$, unless otherwise specified)		
		min.	typ.	max.
R_{DSon}	$V_{GS} = 10\text{V}$; $I_D = I_{D90}$		100	mΩ
V_{GSth}	$V_{DS} = 20\text{V}$; $I_D = 8\text{mA}$	2		V
I_{DSS}	$V_{DS} = V_{DSS}$; $V_{GS} = 0\text{V}$; $T_{VJ} = 25^{\circ}\text{C}$ $T_{VJ} = 125^{\circ}\text{C}$			100 μA 2 mA
I_{GSS}	$V_{GS} = \pm 20\text{V}$; $V_{DS} = 0\text{V}$			100 nA
Q_g Q_{gs} Q_{gd}	$V_{GS} = 10\text{V}$; $V_{DS} = 250\text{V}$; $I_D = 50\text{A}$		330	nC
			55	nC
			155	nC
$t_{d(on)}$ t_r $t_{d(off)}$ t_f	$V_{GS} = 10\text{V}$; $V_{DS} = 380\text{V}$; $I_D = 25\text{A}$; $R_{\theta G} = 1.8^{\circ}\text{C/W}$		45	ns
			60	ns
			120	ns
			45	ns
V_F	(reverse conduction) $I_F = 20\text{A}$; $V_{GS} = 0\text{V}$			V
R_{thJC}	per MOSFET			0.3 K/W

Applications

- Switched mode power supplies (SMPS)
- Uninterruptible power supplies (UPS)
- Power factor correction (PFC)
- Welding
- Inductive heating

Caution: These Devices are sensitive to electrostatic discharge. Users should observe proper ESD handling precautions.

Module

Symbol	Conditions	Maximum Ratings	
T_{VJ}		-40...+150	°C
T_{stg}		-40...+125	°C
$V_{ISO L}$	$I_{ISO L} \leq 1 \text{ mA}$; 50/60 Hz; $t = 1 \text{ s}$	3600	V~
M_d	Mounting torque (M4)	1.5 - 2.0 14 - 18	Nm lb.in.
a	Max. allowable acceleration	50	m/s ²

Symbol	Conditions	Characteristic Values		
		min.	typ.	max.
d_s	Creepage distance on surface (Pin to heatsink)	11.2		mm
d_A	Strike distance in air (Pin to heatsink)	11.2		mm
Weight			24	g

Dimensions in mm (1 mm = 0.0394")

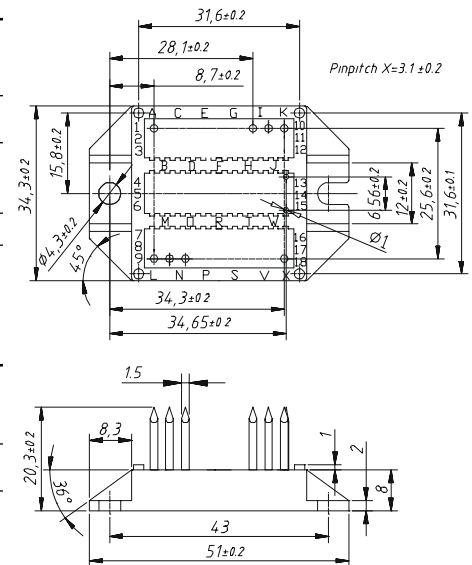

Figure 1. Output Characteristics at 25°C

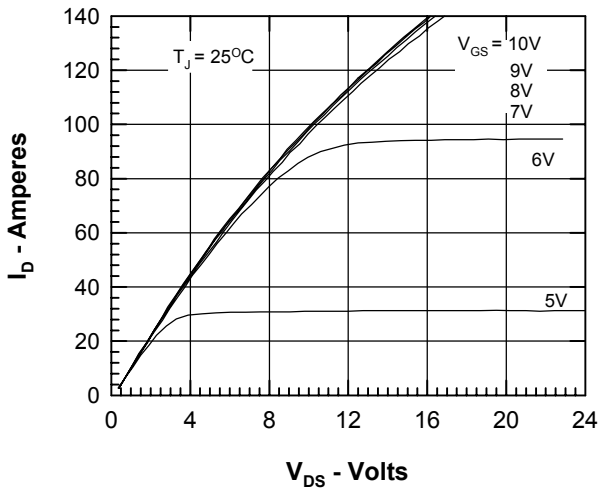

Figure 2. Output Characteristics at 125°C

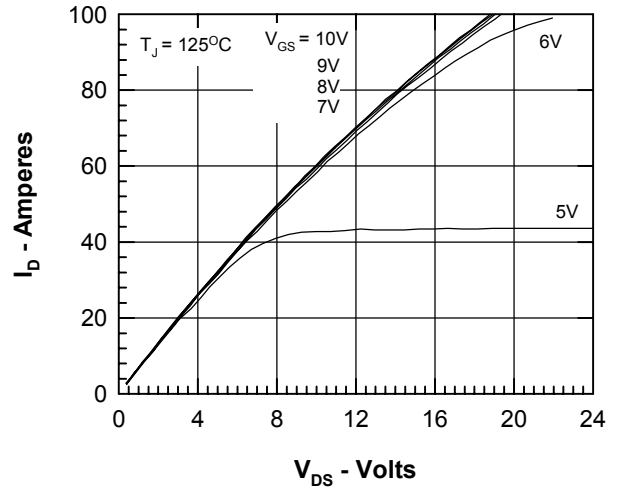

Figure 3. $R_{DS(on)}$ normalized to 0.5 I_{D25} value vs. I_D

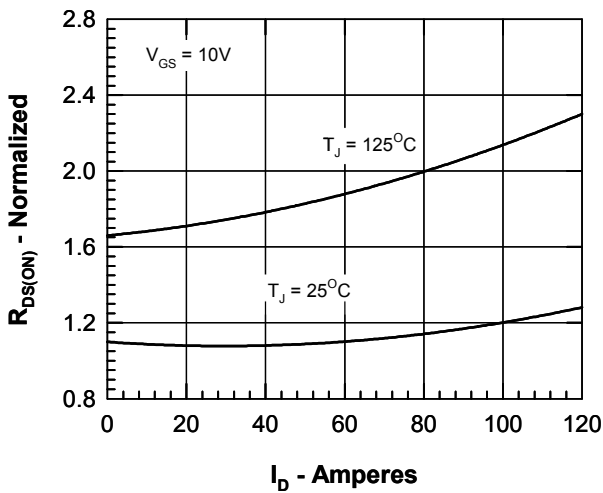

Figure 4. $R_{DS(on)}$ normalized to 0.5 I_{D25} value vs. T_J

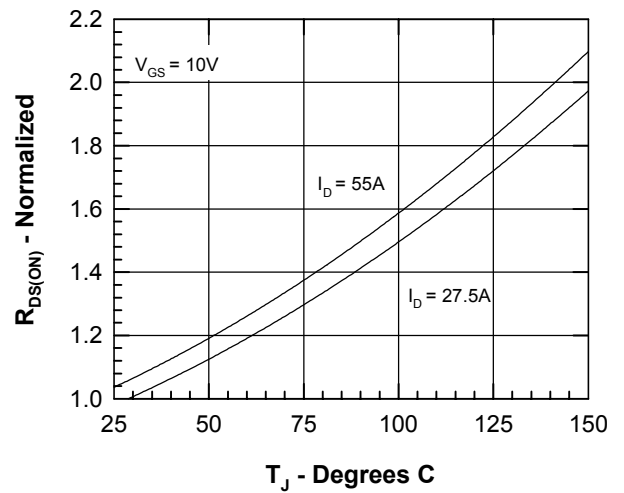

Figure 5. Drain Current vs. Case Temperature

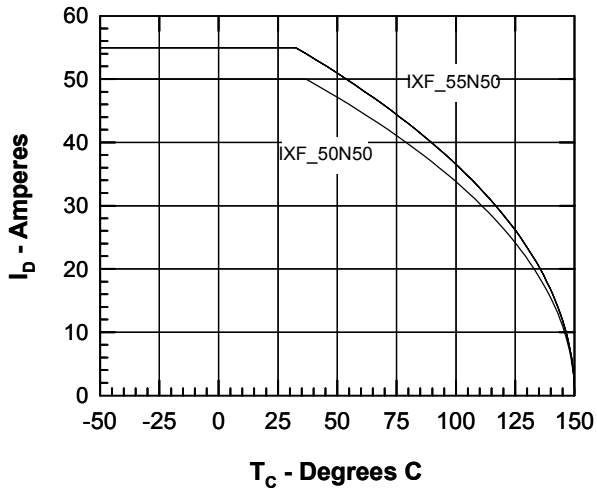

Figure 6. Admittance Curves

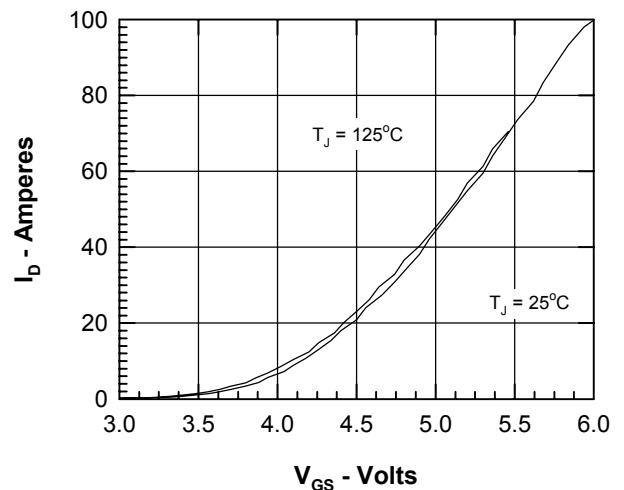

Figure 7. Gate Charge

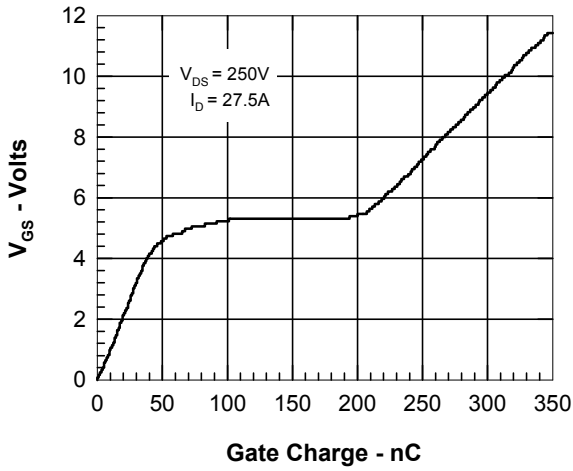

Figure 8. Capacitance Curves

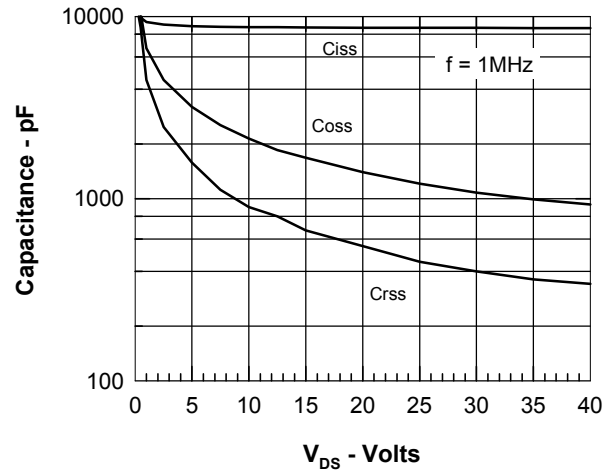

Figure 9. Forward Voltage Drop of the Intrinsic Diode

