

DC-AC INVERTER UNIT

PS-DA0605-01(S) (28 W SIXFOLD OUTPUTS)

(PRELIMINARY INFORMATION)

DESCRIPTION :

This low profile DC to AC Inverter is developed for sixfold lamps.

APPLICABLE LCD:

- Lamp Voltage 780 Vrms
- Lamp Current 6 x 6.0 mArms
- Lamp Start Up Voltage 1.700 Vrms (Vin : 12 Vdc)

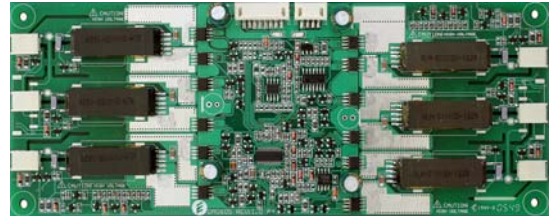

FEATURES :

- Remote ON/OFF
- Wide Dimming Range
- Dimming With Ext.- PWM and / or Current Dimming
- CCFL-Pairs Switchable
- RoHS compliant (S)

TEMPERATURE & HUMIDITY :

- Operating Temperature Range 0°C ~ +60°C
- Storage Temperature Range -20°C ~ +85°C
- Humidity 95 %RH max

DIMENSIONS : L x W x H 200 x 85 x 12 mm

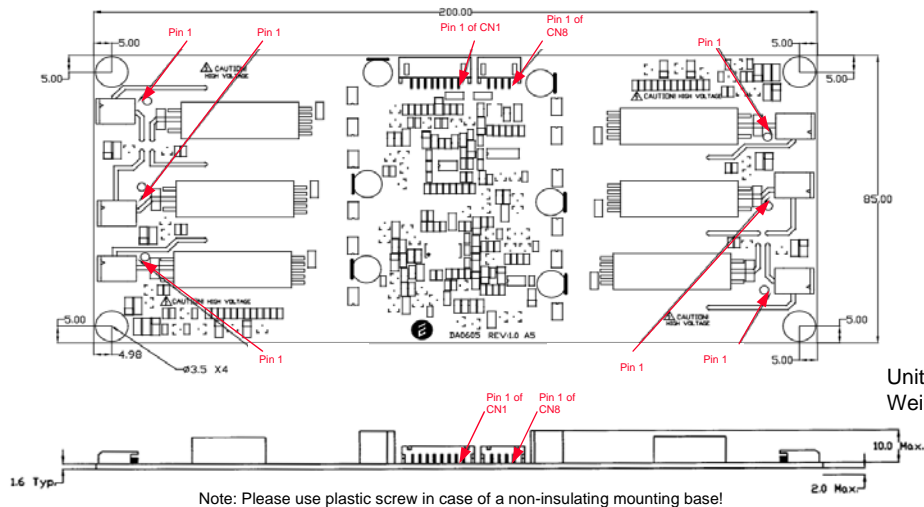

Unit : mm
Weight :64 (g) typ.

Components

No.	Part Description	Qty.	Material	Note
1	PCB	1	UL94V-0 (FR-4 or CEM-3)	t=1.6mm
2	Connector CN1	1	S8B-PH-SM3-TB	JST or equal
3	Connector CN8	1	S4B-PH-SM3-TB	JST or equal
4	Connector CN2 ~ CN7	6	SM02B-BHSS-1-TB	JST or equal

Power Systems – The Power Solution

Web: www.Power-Systems.de
Email: Info@Power-Systems.de

Address: Hauptstr. 48 ; 74360 Ilfeld-Auenstein / Germany
Tel. : + 49 / 70 62 / 67 59 - 6
Fax: + 49 / 70 62 / 67 59 - 800

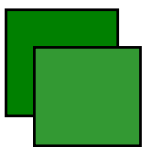

DC-AC INVERTER UNIT

PS-DA0605-01(S) (28 W SIXFOLD OUTPUTS)

(PRELIMINARY INFORMATION)

Input side CN1:

Pin No.	Symbols	Ratings
CN 1-1+2+3	V _{in}	10.8 ~ 13.2 Vdc
CN 1-4+5+6	GND	-
CN 1-7	V _{br}	0 ~ 5 Vdc
CN 1-8	V _{rmt}	0 ~ 1.5 = OFF / 2.5 ~ 5.5 = ON

Output side CN2 ~ CN7

Pin No.	Symbols	Ratings
CN 2-1	V _{high}	800 Vrms (6.0 mArms)
CN 2-2	V _{low}	(GND)

Input side CN8

Pin No.	Symbols	Ratings
CN 8-1	V _{lamp1}	0 ~ 1.5 = OFF / 2.5 ~ 5.0 = ON
CN 8-2	V _{lamp2}	0 ~ 1.5 = OFF / 2.5 ~ 5.0 = ON
CN 8-3	V _{adj}	0 ~ 3 Vdc
CN 8-4	GND	

ELECTRICAL CHARACTERISTICS :

Parameters	Symbols	Conditions			Specification			Unit	Note
		V _{in} (V)	V _{br} (V)	T _u (°C)	Min.	Typ.	Max.		
Output Current	I _{out}	12±1.2	0.0	0 ~ +60	5.5	6.0	6.5	mArms	
Output Current	I _{out}	12±0.6	5.0	0 ~ +60	-	18	-	%	
Input Current	I _{in}	12±1.2	0.0	0 ~ +60	-	2.3	3.0	Adc	
Frequency	F	12±1.2	0.0	0 ~ +60	50	53	57	kHz	
Open Circuit Voltage	V _{open}	11.4	0.0	0 ~ +60	1.550	1.700	2.000	Vrms	
No load Shutdown	T _{sd}	12±1.2	0.0	0 ~ +60	1.0	-	-	sec	without load

Note 1 : Please keep minimum of 2mm clearance (all directions) between inverter high voltage area as marked on mechanical drawing and any conductors.

Note 2: V_{adj} = 0V or open, Output Current Max. and V_{adj} = 3V then Output Current = 3.5 ~ 4.5 mA

Note 3: Please request for other CCFL-current.

Note 4: Before apply any control signal into inverter, please provide V_{cc} first. Please follow the reversed sequence during power off. Power off control signal first, then power off V_{cc}.

Power Systems – The Power Solution

Web: www.Power-Systems.de
 Email: Info@Power-Systems.de

Address: Hauptstr. 48 ; 74360 Ilfeld-Auenstein / Germany
 Tel. : + 49 / 70 62 / 67 59 - 6
 Fax: + 49 / 70 62 / 67 59 - 800

DC-AC INVERTER UNIT

PS-DA0605-01(S) (28 W SIXFOLD OUTPUTS)

(PRELIMINARY INFORMATION)

Dimming Characteristic:

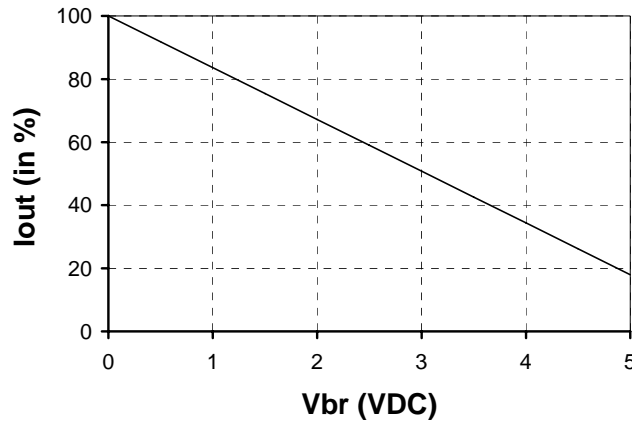

TEST CIRCUIT :

SW1	Operation of unit
a	Operation
b	Non Operation

SW2	Operation of unit
a	Operation
b	Non Operation

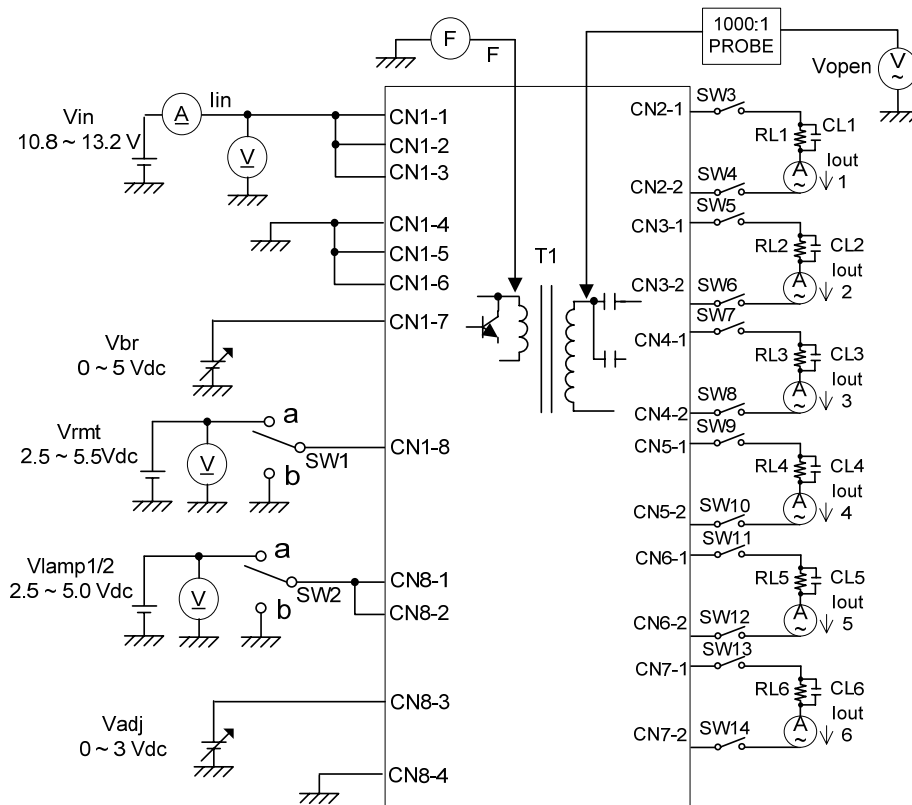

Power Systems – The Power Solution

Web: www.Power-Systems.de
 Email: Info@Power-Systems.de

Address: Hauptstr. 48 ; 74360 Ilsfeld-Auenstein / Germany
 Tel. : + 49 / 70 62 / 67 59 - 6
 Fax: + 49 / 70 62 / 67 59 - 800

DC-AC INVERTER UNIT

BACKLIGHT INVERTER INSTALLATION INSTRUCTION

Precautionary Notes Regarding the Use of This Inverter

When using this product, give due consideration to the precautionary notes described below and ensure a safe design. Inappropriate use may result in electric shock, injury or fire.



WARNING



- This product is subject to high voltage. Do not touch it while the power is on. Failing to do so may result in electric shock.



CAUTION

- This product is designed for the lighting of a Cold Cathode Fluorescent Lamp. Do not use it with any other load.
- Store this product under the conditions defined in the specification document.
- Do not store this product in an environment where dust, dirt or corrosive gas (salt, acid, base, etc.) is present.
- This product is subject to high voltage. If there is a possibility that the user may touch the product, provide a proper indication in order to draw the user's attention.
- This product is designed for use with general electronic equipment. If it is to be used with medical equipment that directly affects human life or for the control of transportation equipment to which passengers entrust their lives, provide thorough fail-safe measures.
- Avoid using this product under high temperatures or high humidity or in an environment in which dust, dirt or any corrosive gas (salt, acid, base, etc.) is present. Also, be careful not to allow the formation of dew condensation. It may result in damage or electric shock.
- If the product does not have a built-in protective circuit (circuit breaker, fuse, etc.), it is recommended that a fuse be used at the input stage to prevent the generation of smoke or fire in the event of a malfunction. Even when the product has a built-in protective circuit (circuit breaker, fuse, etc.), the circuit may not function properly due to inappropriate operating conditions or power-supply capacity. It is recommended that an appropriate protective circuit (circuit breaker, fuse, etc.) be provided separately from the built-in circuit.
- Use the product only within the specified input voltage, output power, output voltage and operating temperature ranges. Exceeding these values may result in damage, etc. Abnormal voltage may result in damage, etc.
- Provide a measure for the prevention of surge voltage due to lightning, etc. Abnormal voltage may result in damage, etc.
- To prevent problems arising from short-circuiting of the high-voltage section, provide appropriate measures to prevent the entry of foreign substances following installation.
- This product is not designed to provide resistance to radiation.

HANDLING PRECAUTIONS

- This product uses thin wires. Observe the following precautions and handle it with care so as not to cause wire breakage. Broken wire may result in damage, etc.

**Do not stack multiple products on top of one another,
Do not allow the product to come in contact with tools, etc.**

- Do not apply excessive stress during installation. It may cause chipping and cracking, resulting in damage, etc.
- Provide a clearance of 2 mm or more between the high-voltage section of this product and the frame body on which the product is installed and also the conductor section (pattern, pad, etc.)

Power Systems – The Power Solution

Web: www.Power-Systems.de
Email: Info@Power-Systems.de

Address: Hauptstr. 48 ; 74360 Ilfeld-Auenstein / Germany
Tel. : + 49 / 70 62 / 67 59 - 6
Fax: + 49 / 70 62 / 67 59 - 800

DC-AC INVERTER UNIT

Thank you very much for usually patronizing Power Systems and TDK's DC/AC inverter. Following the expansion of it's use, there are unexpected troubles that are caused by mis-use or mis-handling because the DC/AC inverter generates a high voltage of 900Vrms or more. Hereafter, the cases of the major troubles are described. Please also refer to "Notes of used" of the attached paper.

Ex.1 Multilayered PWB

Inverter was mounted the nearest to the main board because there is no surface pattern. However, dielectric breakdown happened because there was a low-voltage pattern in internal layer, and they were damaged by arc fire.

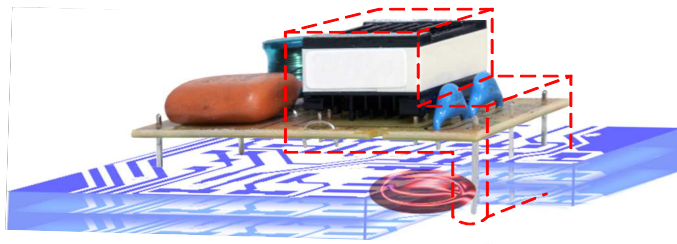

Ex.2 Foreign body

Short of high voltage area by insect (cockroach etc.) having invaded installed set in food processing plant and counter, etc. Short by adhesion of metal powder when using it by set such as NC machine tool.

Ex.3 Mechanical stress

Parts will be cracked or the wire of transformer will be broke, etc. When the mechanical stress was given at the installation on the set.

Ex.4 Storage, handling

When you store it, if the product is piled up or grabed with other inverters together at once, etc. these will be the cause of the break of transformer's wire and etc.

CABLES CONNECTION

- 1.) Don't extend cables.
 - 1.1.) Don't cut through nor solder them, unless you have consulted the manufacture.
- 2.) Don't exchange cables.
 - 2.1.) Polarity is very important otherwise -will be able to a short circuit.
 - there might be a short circuit.(Please refer to fig.1)

Fig. 1

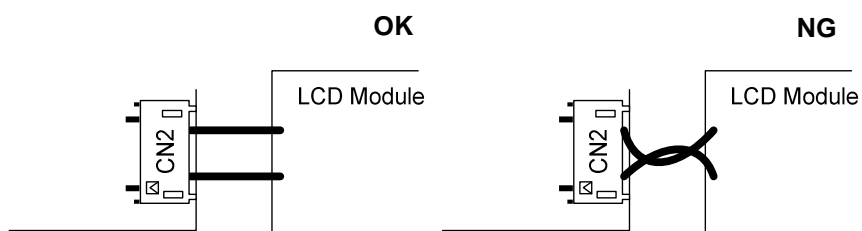

Power Systems – The Power Solution

Web: www.Power-Systems.de
 Email: Info@Power-Systems.de

Address: Hauptstr. 48 ; 74360 Ilsfeld-Auenstein / Germany
 Tel. : + 49 / 70 62 / 67 59 - 6
 Fax: + 49 / 70 62 / 67 59 - 800