



AKD5381-B

AK5381 Evaluation Board Rev.1

GENERAL DESCRIPTION

AKD5381-B is an evaluation board for the digital audio 24bit 96kHz A/D converter, AK5381. AKD5381-B has analog input circuits and a digital interface transmitter, and can achieve the interface with digital audio systems via opt-connector.

■ **Ordering guide**

AKD5381-B --- AK5381 Evaluation Board

FUNCTION

- **DIT (AK4114) with optical output**

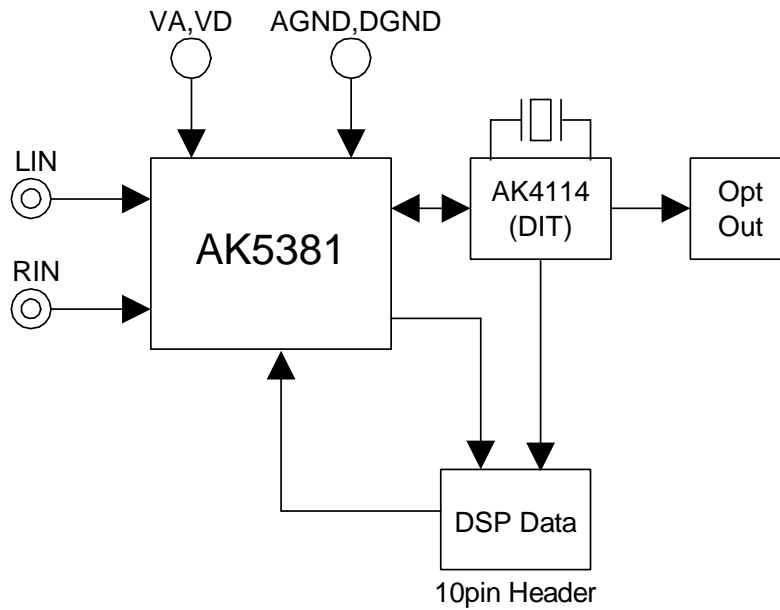

Figure 1. AKD5381-B Block Diagram

* Circuit diagram and PCB layout are attached at the end of this manual.

1. Evaluation Board Manual

■ Operation sequence

1) Set up the power supply lines.

[VA]	(red)	= 2.7 ~ 5.5V or +15V	: for VA of AK5381 (typ. 5.0V)
[VD]	(orange)	= 2.7 ~ 5.5V	: for VD of AK5381, 74HC14 (typ. 5.0V)
[VCC]	(red)	= 3.3V	: for AK4114
[AGND]	(black)	= 0V	: for analog ground
[DGND]	(black)	= 0V	: for logic ground

Each supply line should be distributed from the power supply unit.

2) Set up the evaluation mode, jumper pins and DIP switches. (See the followings.)

3) Power on.

The AK5381 and AK4114 should be reset once bringing SW2 = "L" upon power-up.

■ Evaluation mode

(1) Slave Mode

(1-1) A/D evaluation using DIT function of AK4114

PORT2 (DIT) is used. DIT generates audio bi-phase signal from received data and which is output through optical connector (TOTX141). It is possible to connect AKM's D/A converter evaluation boards on the digital-amplifier, which equips DIR input. Nothing should be connected to PORT1 (DSP).

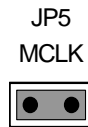

(1-2) All interface signals including master clock are fed externally.

PORT1 (DSP) is used. All interface signals (MCLK, SCLK, LRCK) are provided to the AK5381 through PORT1. JP5 (MCLK) should be open. The DIF1 of SW1 (MODE) should be set to "H".

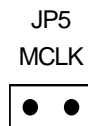

(2) Master Mode

(2-1) A/D evaluation using DIT function of AK4114

PORT2 (DIT) is used. DIT generates audio bi-phase signal from received data and which is output through optical connector (TOTX141). It is possible to connect AKM's D/A converter evaluation boards on the digital-amplifier, which equips DIR input. Nothing should be connected to PORT1 (DSP). The DIF1 of SW1 (MODE) should be set to "H".

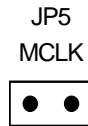

(2-2) Master clock is fed externally.

PORT1 (DSP) is used. MCLK is provided to the AK5381 through PORT1. JP5 (MCLK) should be open. The DIF1 of SW1 (MODE) should be set to "H".

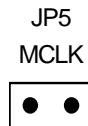

■ Other jumper pins set up

1. JP1 (GND) : Analog ground and Digital ground
 OPEN : Separated.
 SHORT : Common. (The connector "DGND" can be open.) <Default>
2. JP2 (CKS1) : Setting of CKS1 pin for AK5381
 H : Master mode
 L : Slave mode <Default>
3. JP3 (VA) : Select VA for AK5381
 VA : Supply from VA connector <Default>
 REG : Supply from regulator. VA connector should be supplied +15V.
4. JP4 (VD) : Select VD for AK5381
 VA : Supply from VA connector
 VD : Supply from VD connector <Default>

■ DIP Switch set up

[SW1] (MODE1): Setting the evaluation mode for AK5381 and AK4114
ON is “H”, OFF is “L”. CKS1 should be set by JP2.

No.	Name	OFF (“L”)	ON (“H”)
1	CKS0	See Table 2	
2	CKS2		
3	DIF	MSB justified	I ² S Compatible
4	DIF1	AK4114 Master mode	AK4114 Slave mode

Table 1. Mode Setting

CKS2	CKS1	CKS0	Input Level	HPF	Master/Slave	MCLK	SCLK	
L	L	L	CMOS	ON	Slave	256/384/512/768fs	≥ 48fs or 32fs	
L	L	H	CMOS	OFF	Slave	256/384/512/768fs	≥ 48fs or 32fs	
L	H	L	CMOS	ON	Master	256fs (~ 96kHz)	64fs	
L	H	H	CMOS	ON	Master	512fs (~ 48kHz)	64fs	
H	L	L	TTL	ON	Slave	256/384/512/768fs	≥ 48fs or 32fs	
H	L	H	Reserved					
H	H	L	CMOS	ON	Master	384fs (~ 96kHz)	64fs	
H	H	H	CMOS	ON	Master	768fs (~ 48kHz)	64fs	

Table 2. Mode Setting of AK5381

Note: AK4114 does not support MCLK=384fs/512fs/768fs.

PORT1 (DSP) should be used when MCLK=384fs/512fs/768fs.

■ The function of the toggle SW

Upper-side is “H” and lower-side is “L”.

[SW2] (PDN): Resets the AK5381 and AK4114. Keep “H” during normal operation.

■ Analog Input Circuits

Analog signal is input via J1(RIN) and J2(LIN) of RCA connectors.

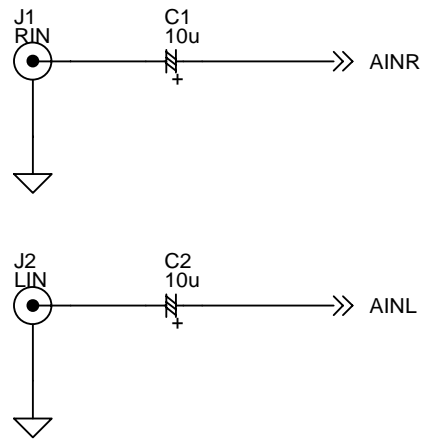

Figure 2. Analog Input circuits

* AKM assumes no responsibility for the trouble when using the circuit examples.

MEASUREMENT RESULTS

[Measurement condition]

- Measurement unit: Audio Precision, System Two Cascade
- MCLK : 256fs
- SCLK : 64fs
- fs : 48kHz, 96kHz
- Bit : 24bit
- Power Supply : VA = VD = 5.0V (Using regulator)
- Interface : DIT
- Temperature : Room

Parameter		Result (Lch / Rch)	Unit
ADC Analog Input Characteristics:			
S/(N+D) (-1dB Input)	fs=48kHz	89.0 / 88.4	dB
	fs=96kHz	86.9 / 86.2	dB
D-Range (-60dB Input)	fs=48kHz, A-weighted	102.7 / 102.4	dB
	fs=96kHz	99.2 / 99.2	dB
S/N	fs=48kHz, A-weighted	102.8 / 102.8	dB
	fs=96kHz	99.4 / 99.4	dB
Interchannel Isolation		123.6 / 123.8	dB

[ADC Plot : fs=48kHz]

AKM

AK5381 THD+N vs. Input Level
VA=VD=5.0V, fs=48kHz, fin=1kHz

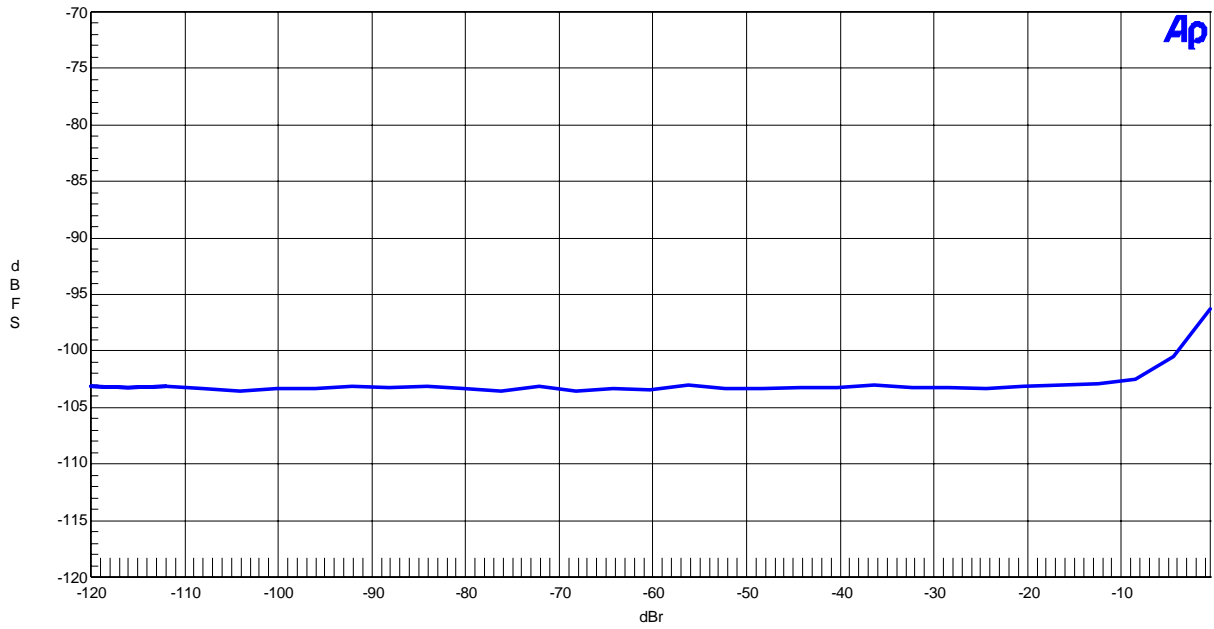

Figure 1. THD+N vs. Input Level

AKM

AK5381 THD+N vs. Input Frequency
VA=VD=5.0V, fs=48kHz, Input=-1dBr

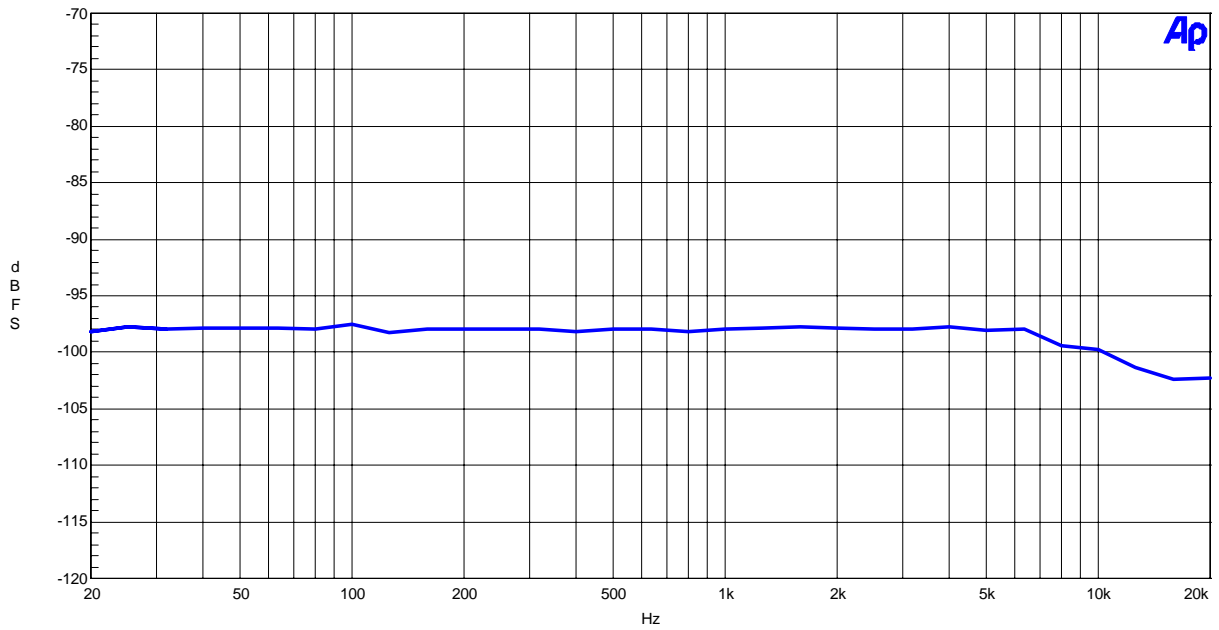

Figure 2. THD+N vs. Input Frequency

AKM

AK5381 Linearity
VA=VD=5.0V, fs=48kHz, fin=1kHz

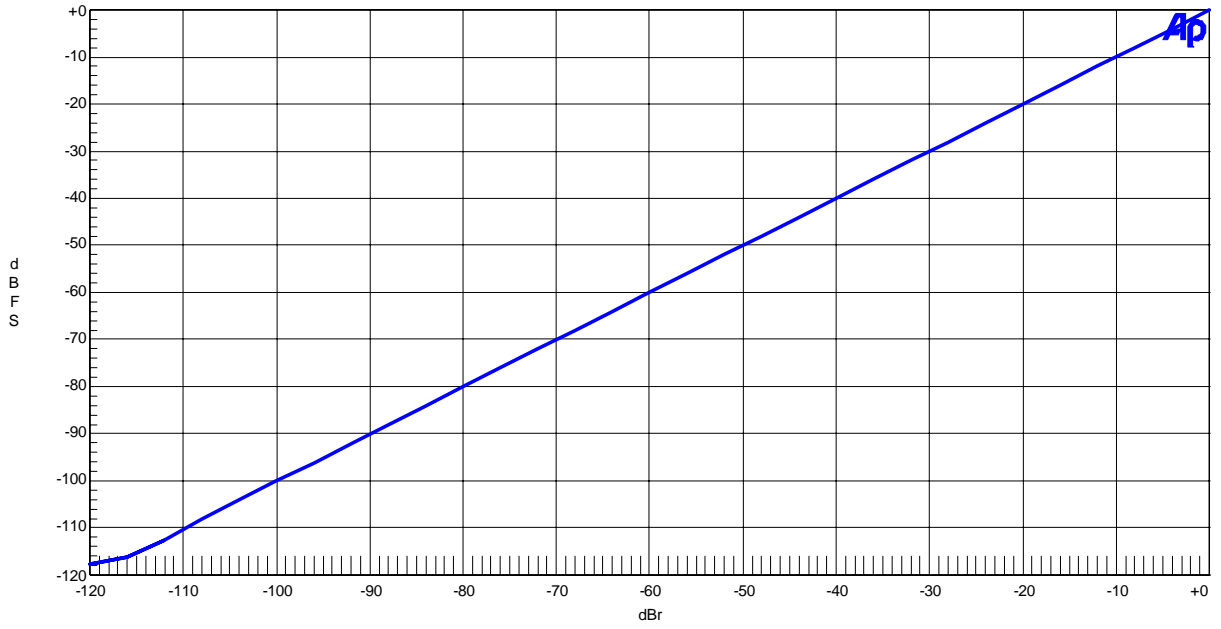

Figure 3. Linearity

AKM

AK5381 Frequency Response
VA=VD=5.0V, fs=48kHz, Input=-1dBr

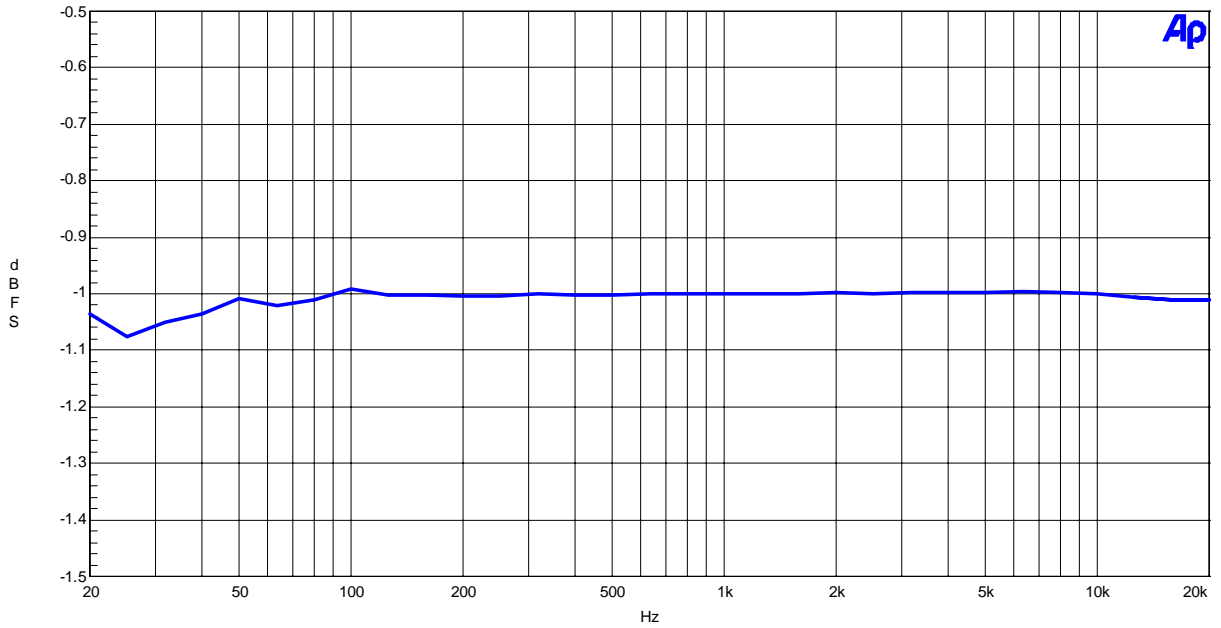

Figure 4. Frequency Response

AKM

AK5381 Crosstalk
VA=VD=5.0V, fs=48kHz, Input=-1dB

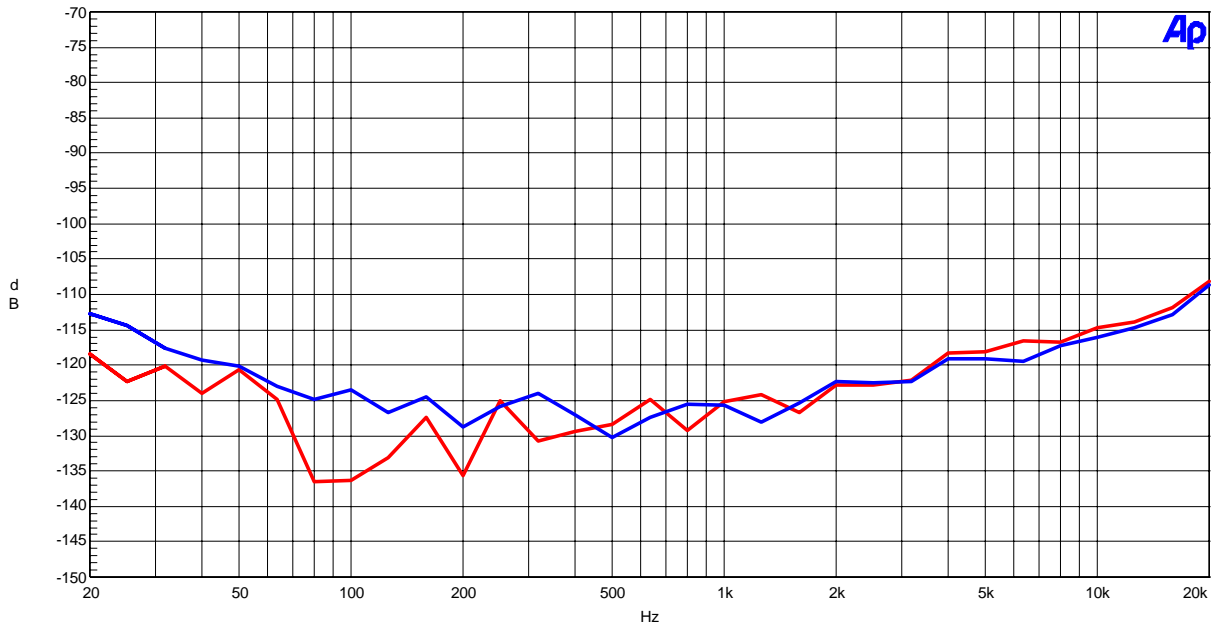

Figure 5. Crosstalk

AKM

AK5381 FFT Plot
VA=VD=5.0V, fs=48kHz, Input=-1dB, fin=1kHz

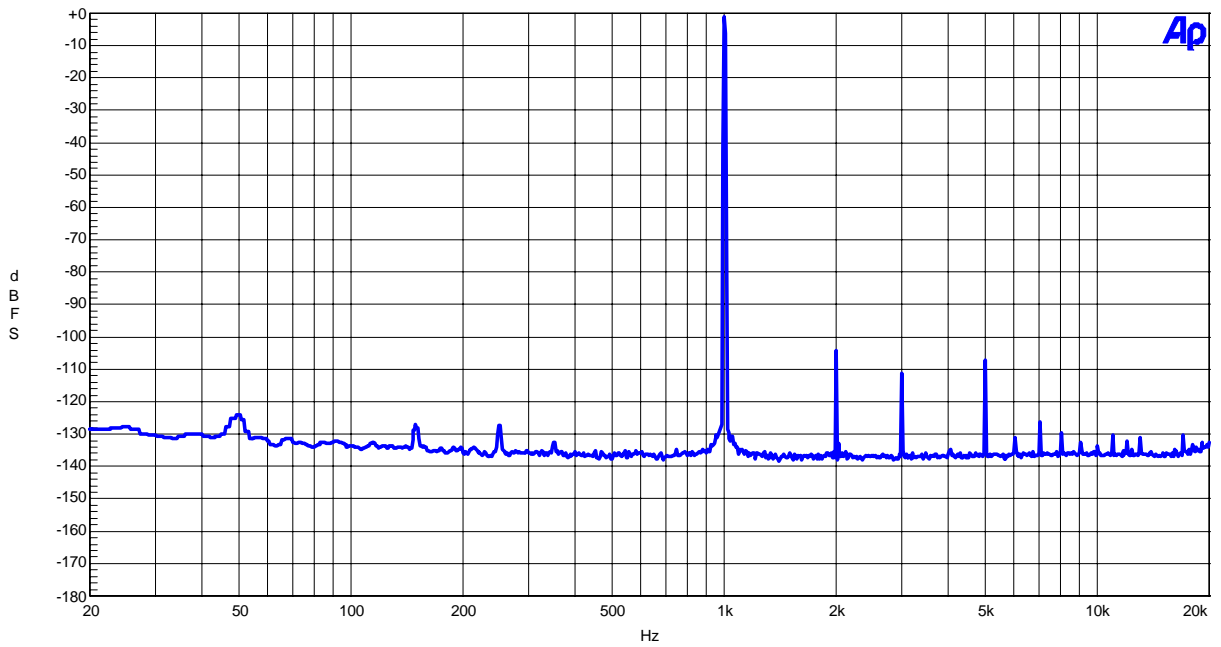

Figure 6. FFT Plot

AKM

AK5381 FFT Plot
VA=VD=5.0V, fs=48kHz, Input=-60dB, fin=1kHz

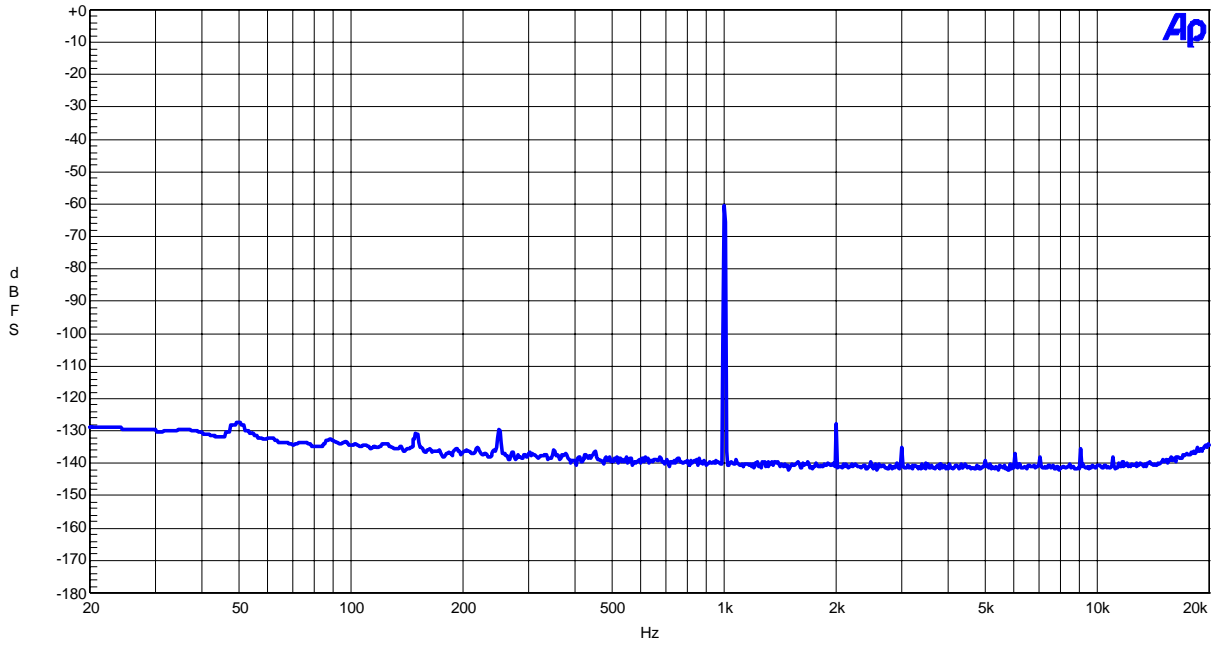

Figure 7. FFT Plot

AKM

AK5381 FFT Plot
VA=VD=5.0V, fs=48kHz, fin=None

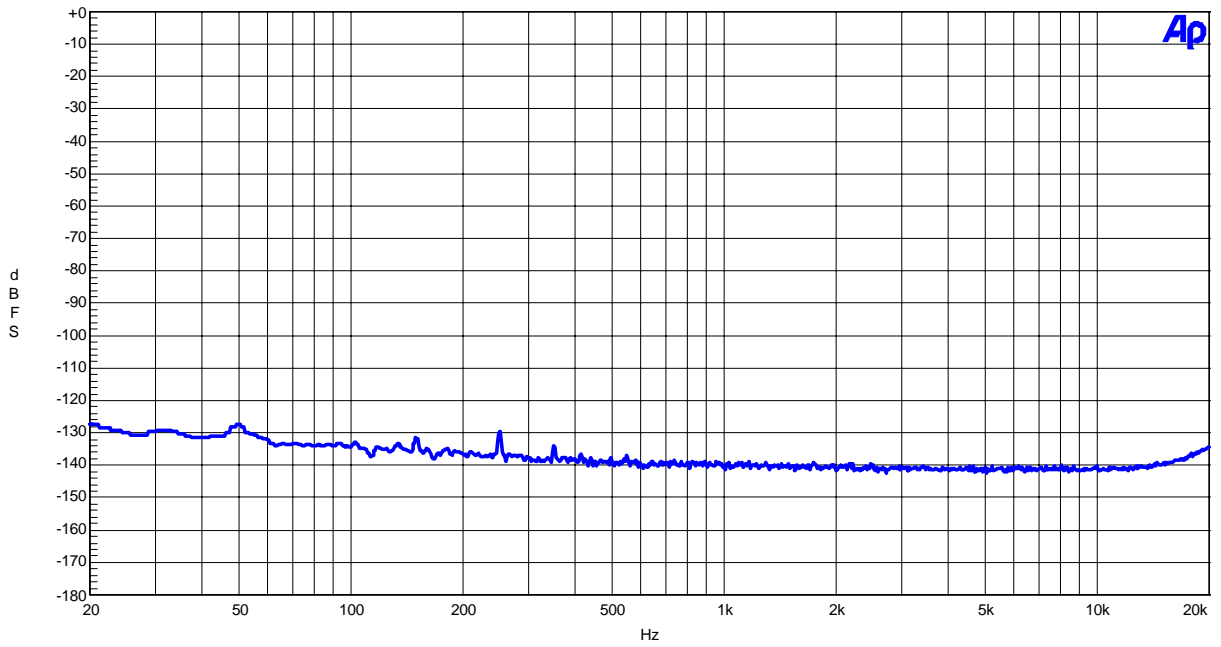

Figure 8. FFT Plot

[ADC Plot : fs=96kHz]

AKM

AK5381 THD+N vs. Input Level
VA=VD=5.0V, fs=96kHz, fin=1kHz

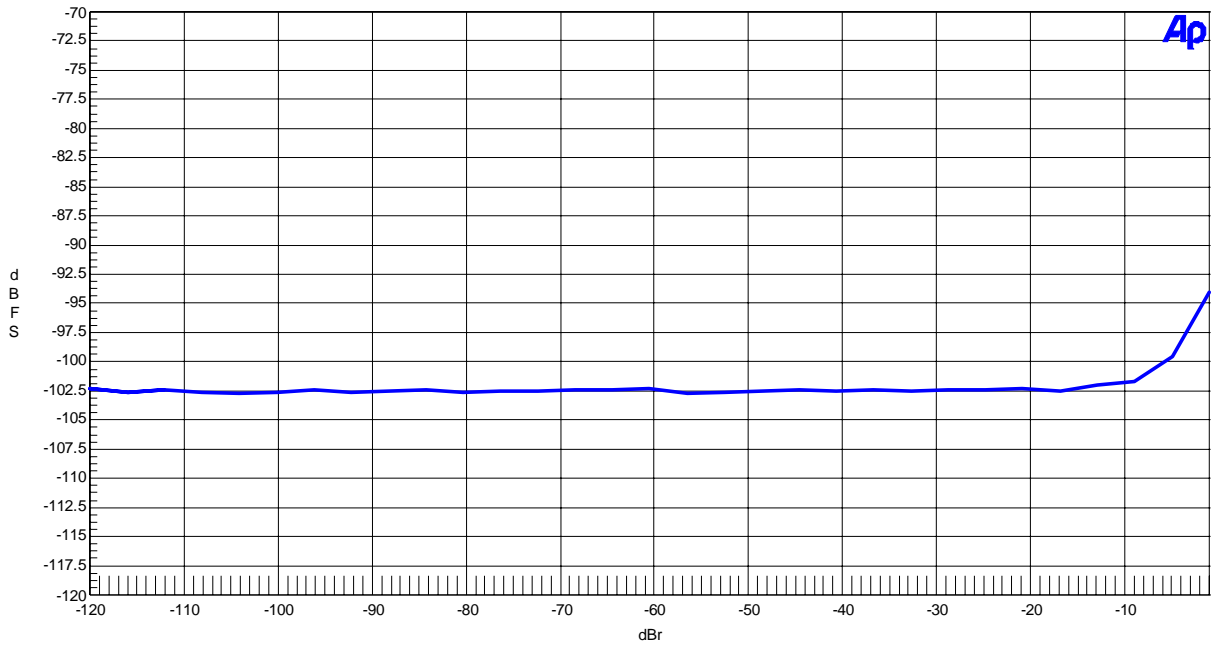

Figure 9. THD+N vs. Input Level

AKM

AK5381 THD+N vs. Input Frequency
VA=VD=5.0V, fs=96kHz, Input=-1dBr

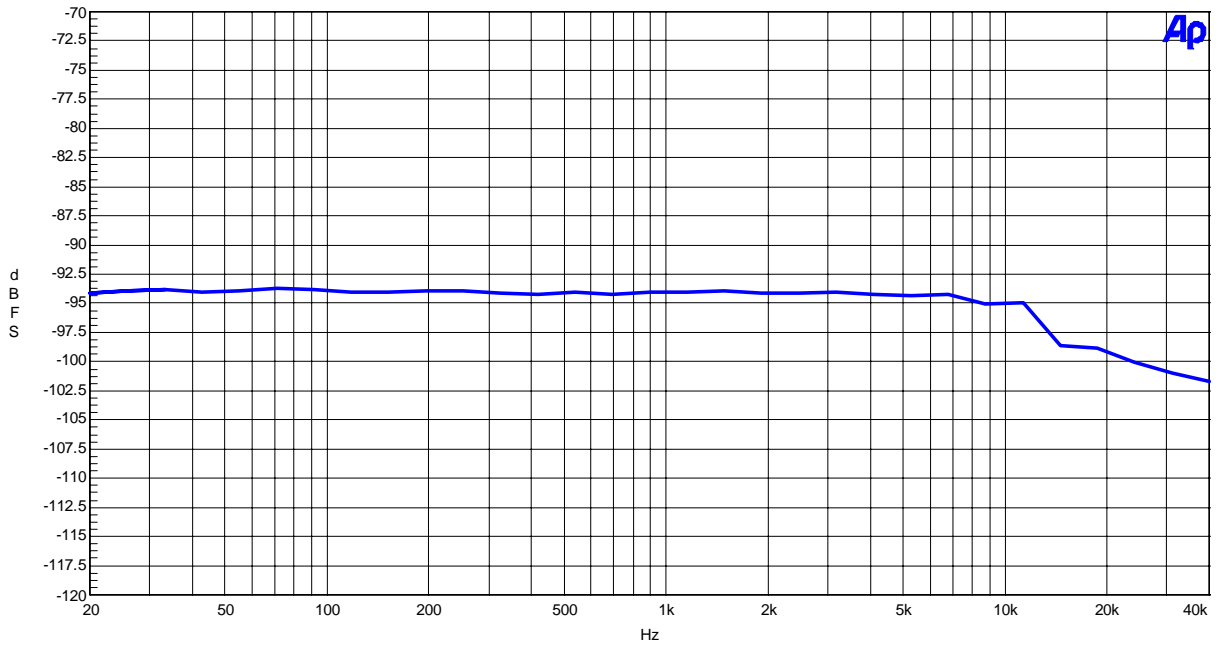

Figure 10. THD+N vs. Input Frequency

AKM

AK5381 Linearity
VA=VD=5.0V, fs=96kHz, fin=1kHz

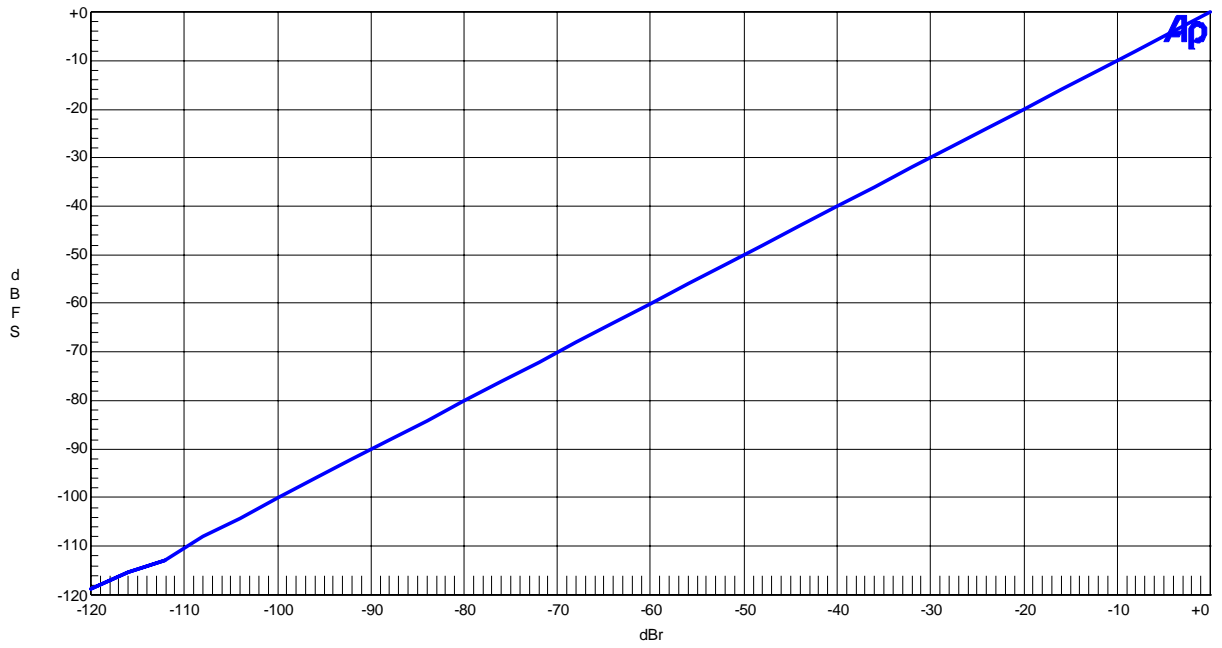

Figure 11. Linearity

AKM

AK5381 Frequency Response
VA=VD=5.0V, fs=96kHz, Input=-1 dBr

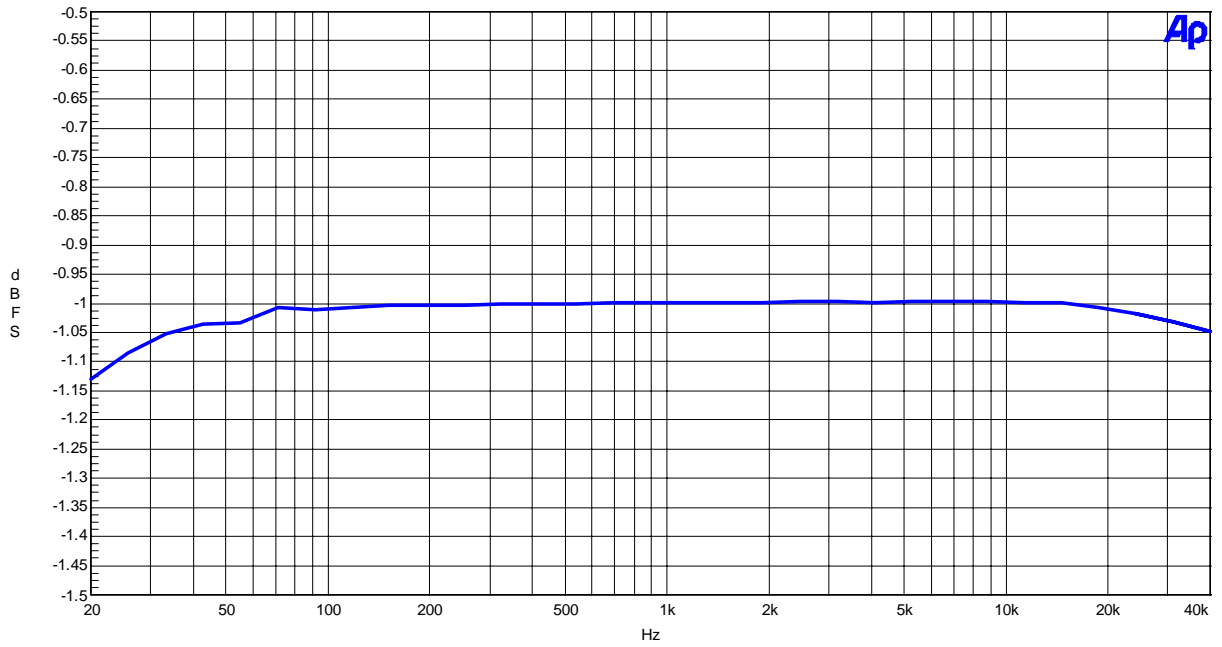

Figure 12. Frequency Response

AKM

AK5381 Crosstalk
VA=VD=5.0V, fs=96kHz, Input=-1dB_r

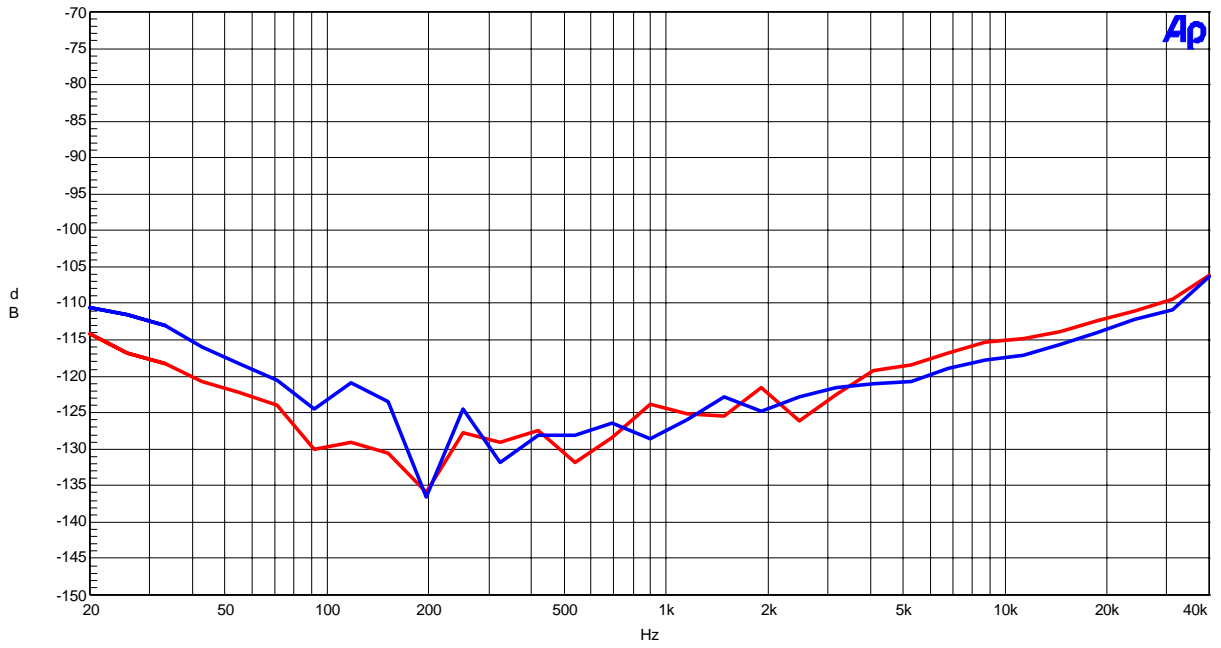

Figure 13. Crosstalk

AKM

AK5381 FFT Plot
VA=VD=5.0V, fs=96kHz, Input=-1dB_r, fin=1kHz

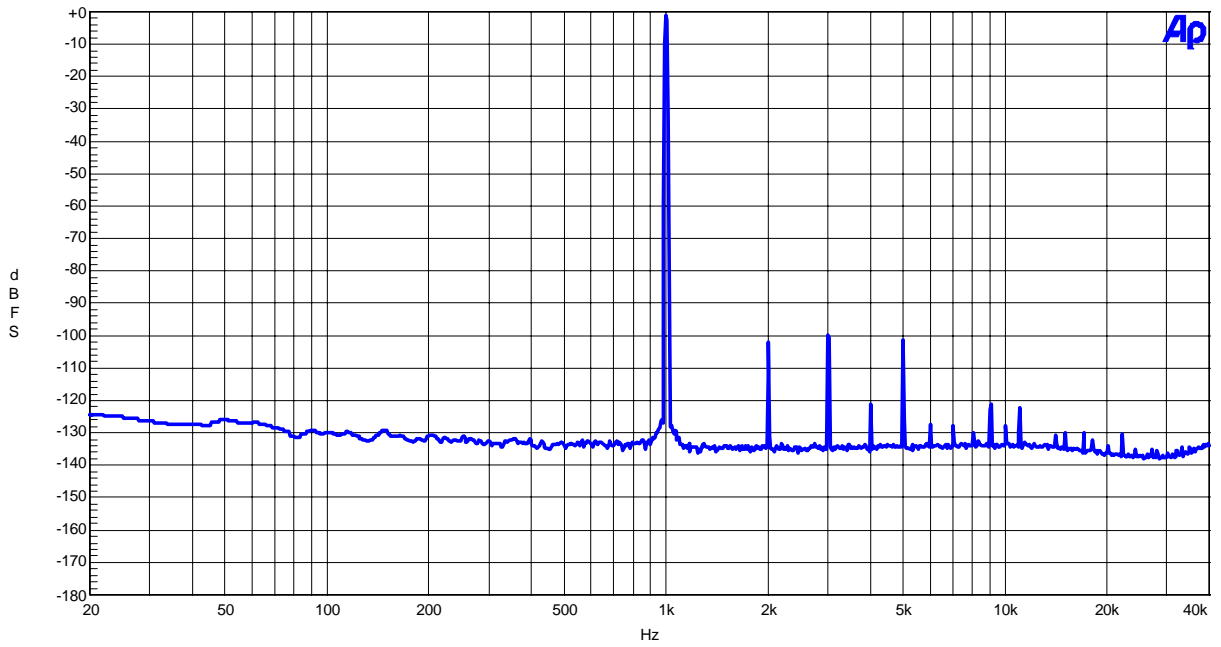

Figure 14. FFT Plot

AKM

AK5381 FFT Plot
VA=VD=5.0V, fs=96kHz, Input=-60dB, fin=1kHz

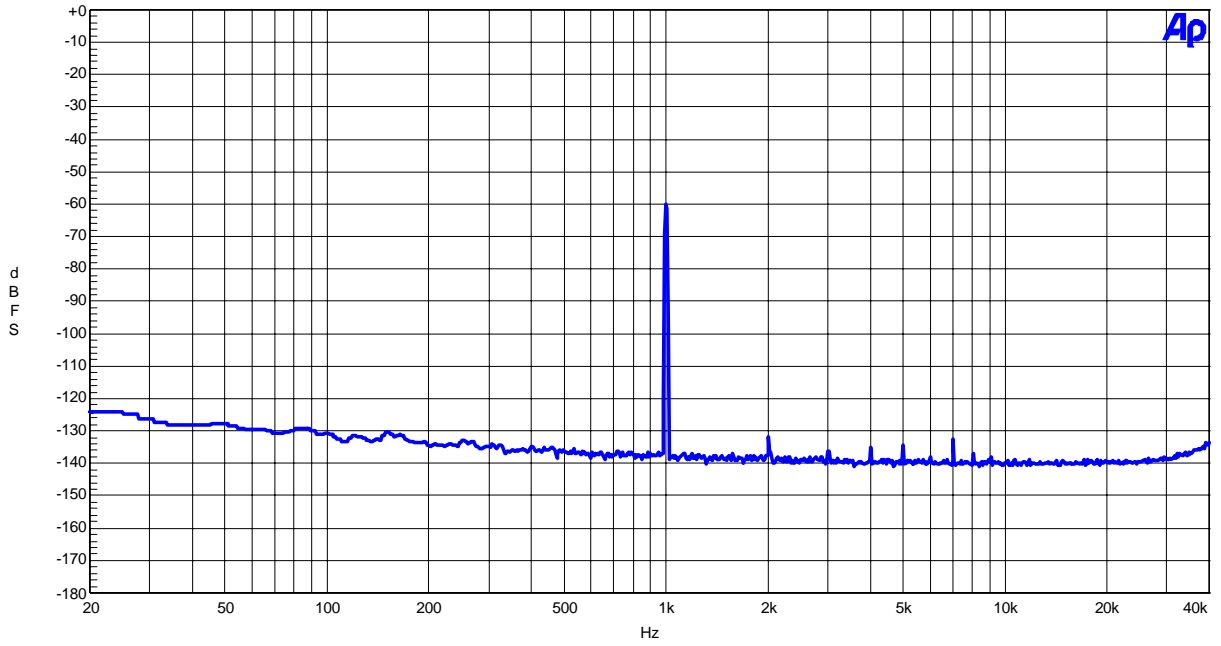

Figure 15. FFT Plot

AKM

AK5381 FFT Plot
VA=VD=5.0V, fs=96kHz, fin=None

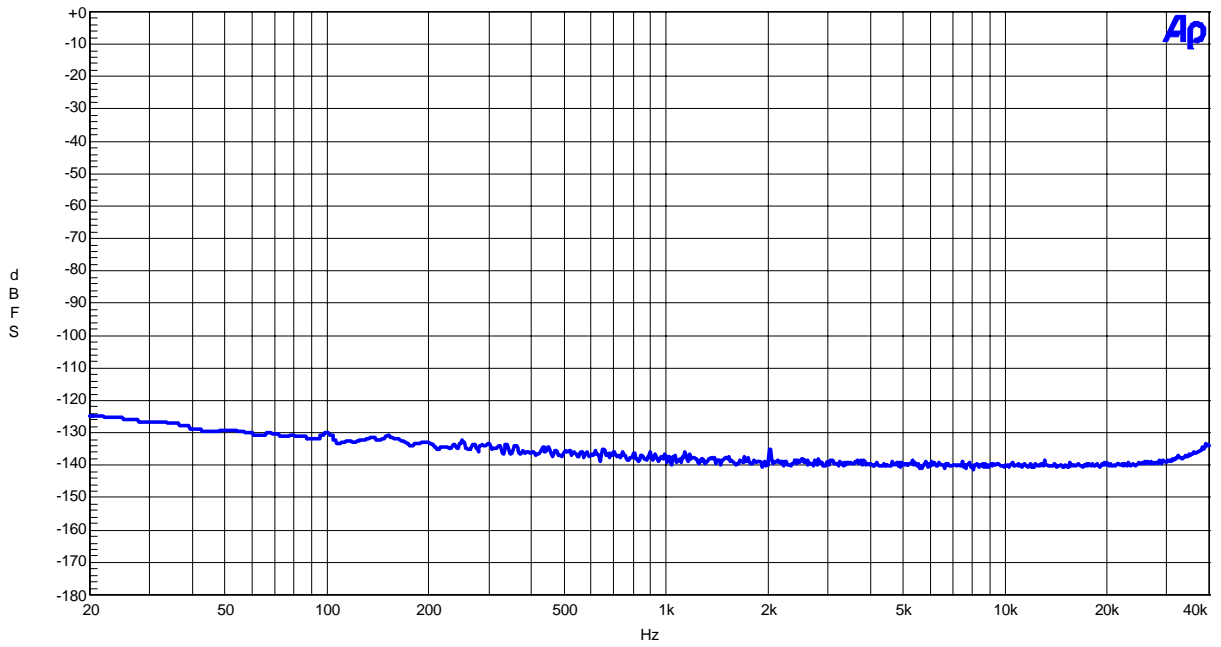

Figure 16. FFT Plot

Revision History

Date (YY/MM/DD)	Manual Revision	Board Revision	Reason	Contents
04/05/14	KM074700		First Edition	
05/01/14	KM074701	0	Board Name Change Circuit Change	AKD5381 Rev.B→AKD5381-B Rev.0 The information on AK5357 was removed.
06/04/24	KM074702	1	Error Correction	Board Rev: 0→1

IMPORTANT NOTICE

- These products and their specifications are subject to change without notice. Before considering any use or application, consult the Asahi Kasei Microsystems Co., Ltd. (AKM) sales office or authorized distributor concerning their current status.
- AKM assumes no liability for infringement of any patent, intellectual property, or other right in the application or use of any information contained herein.
- Any export of these products, or devices or systems containing them, may require an export license or other official approval under the law and regulations of the country of export pertaining to customs and tariffs, currency exchange, or strategic materials.
- AKM products are neither intended nor authorized for use as critical components in any safety, life support, or other hazard related device or system, and AKM assumes no responsibility relating to any such use, except with the express written consent of the Representative Director of AKM. As used here:
 - (a) A hazard related device or system is one designed or intended for life support or maintenance of safety or for applications in medicine, aerospace, nuclear energy, or other fields, in which its failure to function or perform may reasonably be expected to result in loss of life or in significant injury or damage to person or property.
 - (b) A critical component is one whose failure to function or perform may reasonably be expected to result, whether directly or indirectly, in the loss of the safety or effectiveness of the device or system containing it, and which must therefore meet very high standards of performance and reliability.
- It is the responsibility of the buyer or distributor of an AKM product who distributes, disposes of, or otherwise places the product with a third party to notify that party in advance of the above content and conditions, and the buyer or distributor agrees to assume any and all responsibility and liability for and hold AKM harmless from any and all claims arising from the use of said product in the absence of such notification.

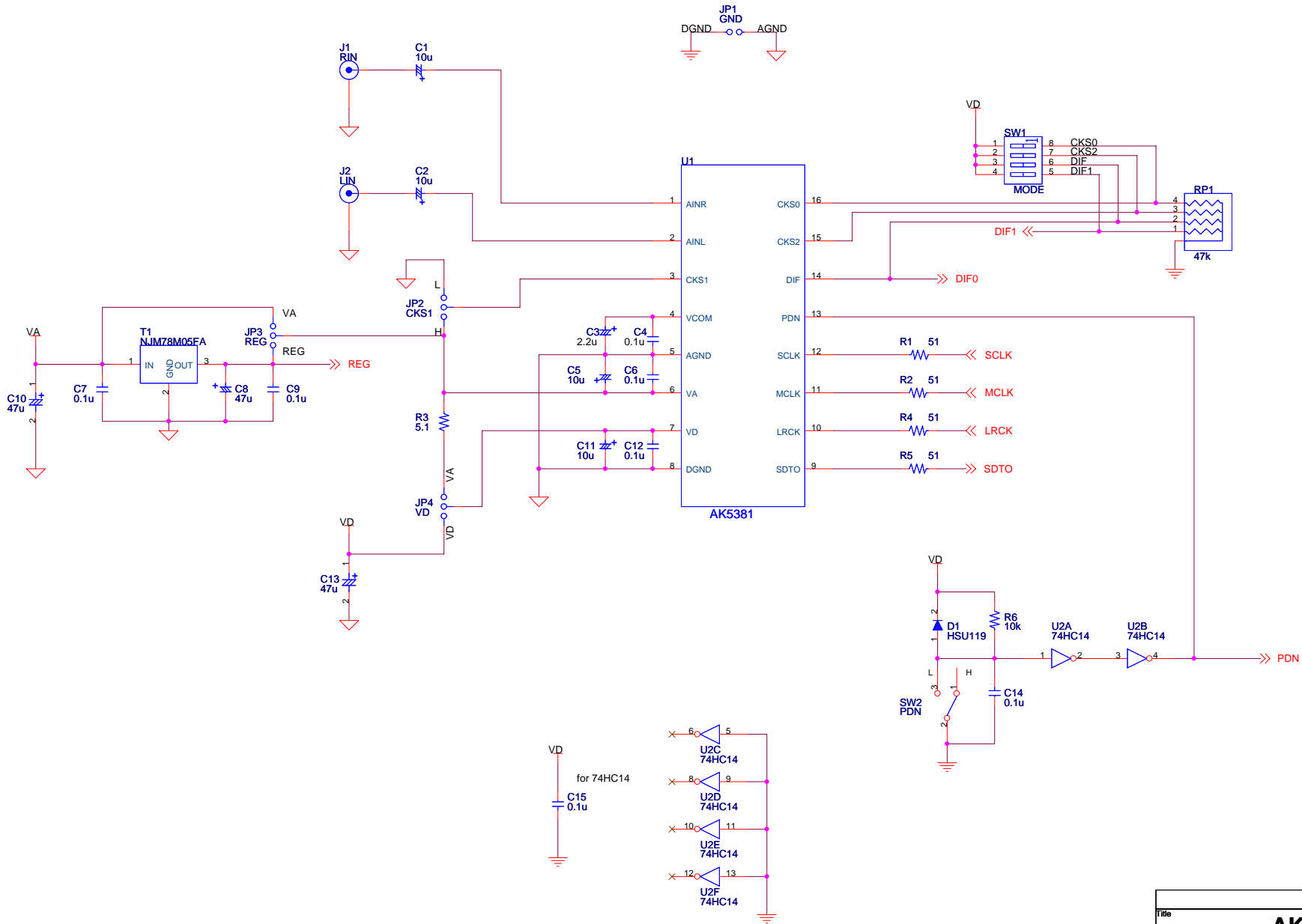

Title		
AKD5381-B		
Size	Document Number	Rev
A3	AK5381	1
Date:	Monday, April 24, 2006	Sheet 1 of 2

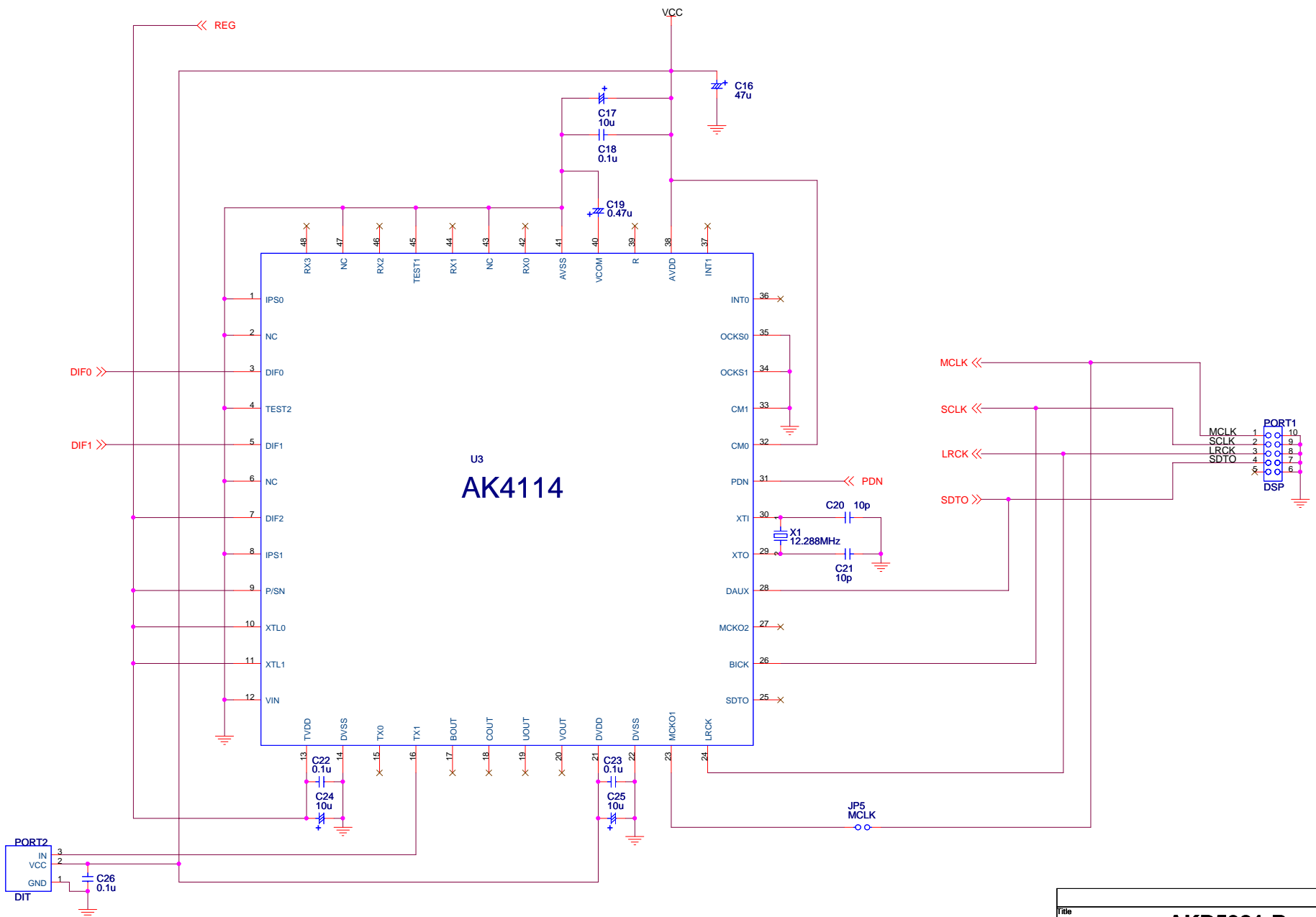

Title			AKD5381-B		
Size	Document Number	AK4114			Rev
A3					1
Date:	Monday, April 24, 2006	Sheet	2	of	2

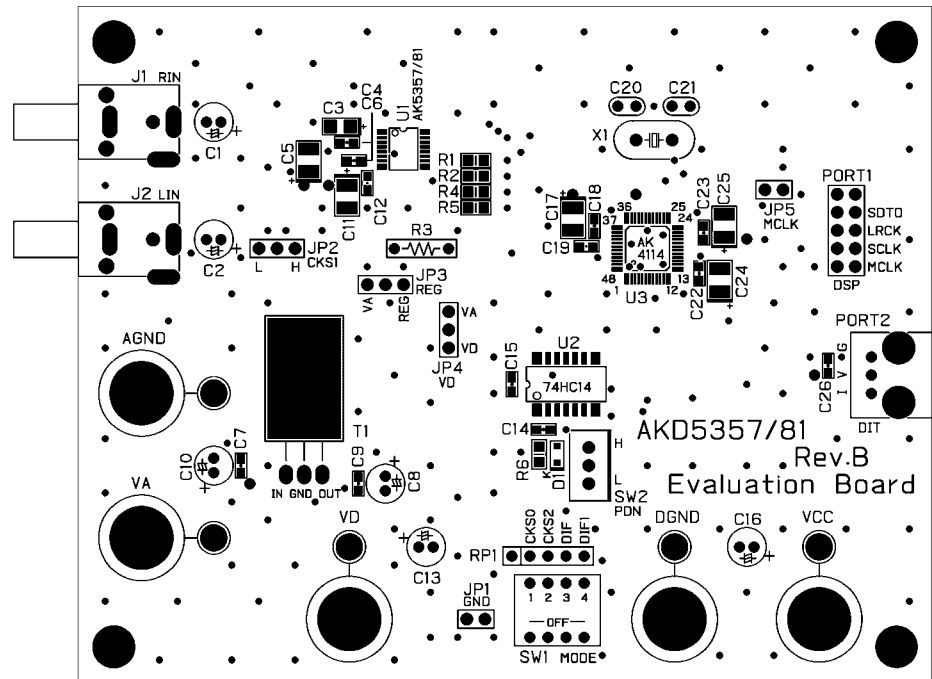

AKD5357/81 Rev.B L1 SR SILK

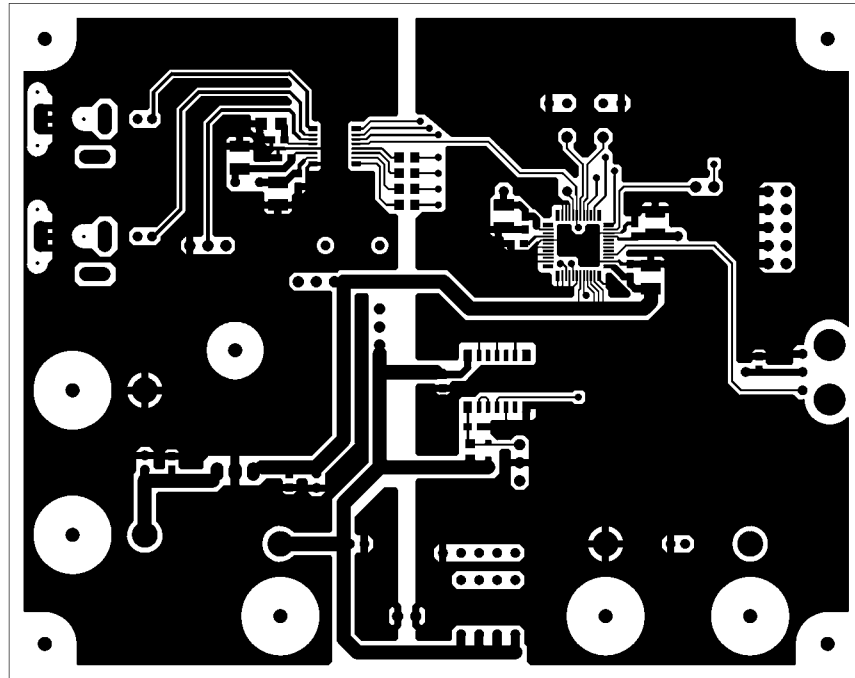

AKD5357/81 Rev.B L1

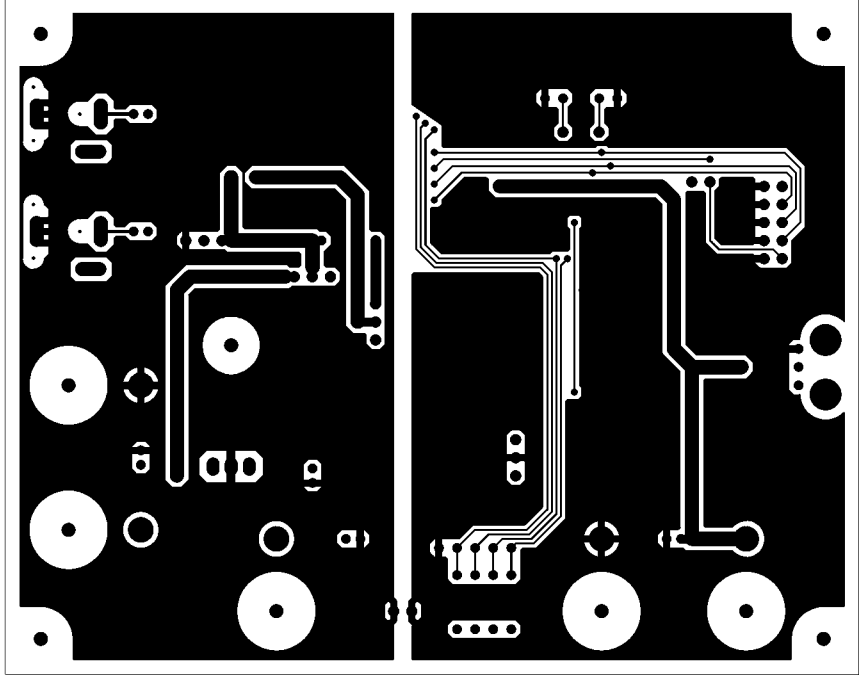

AKD9327\81 Rev.B LS