



SANYO Semiconductors

DATA SHEET

15GN03CA

 — NPN Epitaxial Planar Silicon Transistor
VHF High-frequency Amplifier Applications

Applications

- VHF, RF, MIXER, OSC, IF amplifier.

Features

- High cutoff frequency : $f_T=1.5\text{GHz}$ typ.
- High gain : $|S_{21e}|^2=13\text{dB}$ typ ($f=0.4\text{GHz}$).

Specifications

Absolute Maximum Ratings at $T_a=25^\circ\text{C}$

Parameter	Symbol	Conditions	Ratings	Unit
Collector-to-Base Voltage	V_{CB0}		20	V
Collector-to-Emitter Voltage	V_{CE0}		10	V
Emitter-to-Base Voltage	V_{EB0}		3	V
Collector Current	I_C		70	mA
Collector Dissipation	P_C		200	mW
Junction Temperature	T_j		150	$^\circ\text{C}$
Storage Temperature	T_{stg}		-55 to +150	$^\circ\text{C}$

Electrical Characteristics at $T_a=25^\circ\text{C}$

Parameter	Symbol	Conditions	Ratings			Unit
			min	typ	max	
Collector Cutoff Current	I_{CB0}	$V_{CB}=10\text{V}, I_E=0\text{A}$			0.1	μA
Emitter Cutoff Current	I_{EB0}	$V_{EB}=2\text{V}, I_C=0\text{A}$			1	μA
DC Current Gain	h_{FE}	$V_{CE}=5\text{V}, I_C=10\text{mA}$	100		180	
Gain-Bandwidth Product	f_T	$V_{CE}=5\text{V}, I_C=20\text{mA}$	1.0	1.5		GHz
Output Capacitance	C_{ob}	$V_{CB}=10\text{V}, f=1\text{MHz}$		0.95	1.25	pF
Reverse Transfer Capacitance	C_{re}	$V_{CB}=10\text{V}, f=1\text{MHz}$		0.65		pF

Marking : ZU

Continued on next page.

- Any and all SANYO Semiconductor Co.,Ltd. products described or contained herein are, with regard to "standard application", intended for the use as general electronics equipment (home appliances, AV equipment, communication device, office equipment, industrial equipment etc.). The products mentioned herein shall not be intended for use for any "special application" (medical equipment whose purpose is to sustain life, aerospace instrument, nuclear control device, burning appliances, transportation machine, traffic signal system, safety equipment etc.) that shall require extremely high level of reliability and can directly threaten human lives in case of failure or malfunction of the product or may cause harm to human bodies, nor shall they grant any guarantee thereof. If you should intend to use our products for applications outside the standard applications of our customer who is considering such use and/or outside the scope of our intended standard applications, please consult with us prior to the intended use. If there is no consultation or inquiry before the intended use, our customer shall be solely responsible for the use.
- Specifications of any and all SANYO Semiconductor Co.,Ltd. products described or contained herein stipulate the performance, characteristics, and functions of the described products in the independent state, and are not guarantees of the performance, characteristics, and functions of the described products as mounted in the customer's products or equipment. To verify symptoms and states that cannot be evaluated in an independent device, the customer should always evaluate and test devices mounted in the customer's products or equipment.

SANYO Semiconductor Co., Ltd.

www.semiconductor-sanyo.com/network

15GN03CA

Continued from preceding page.

Parameter	Symbol	Conditions	Ratings			Unit
			min	typ	max	
Forward Transfer Gain	$ S_{21e} ^2$	$V_{CE}=5V, I_C=20mA, f=0.4GHz$	10	13		dB
Noise Figure	NF	$V_{CE}=3V, I_C=2mA, f=0.4GHz$		1.6		dB

Package Dimensions

unit : mm (typ)

7013A-009

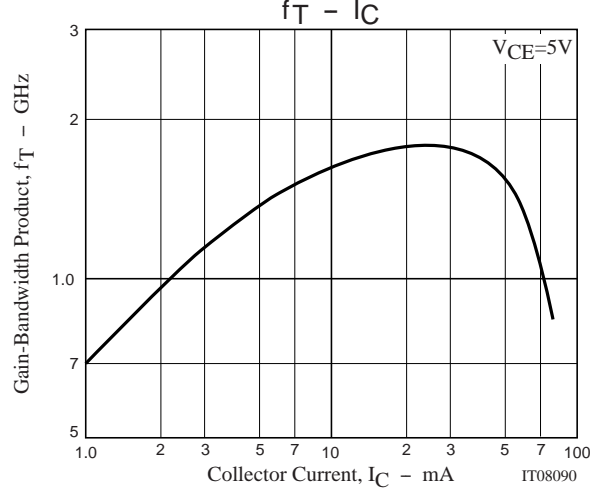
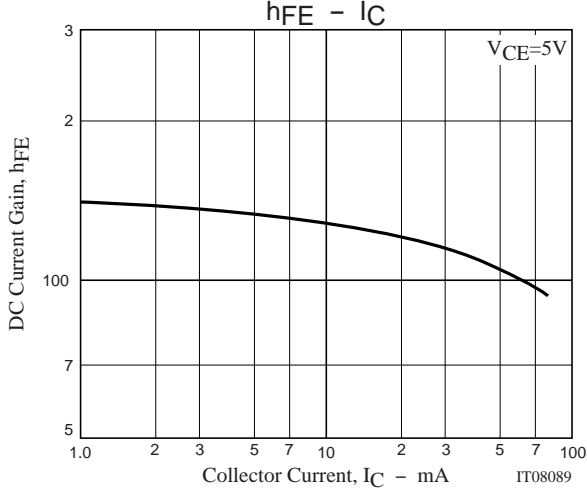
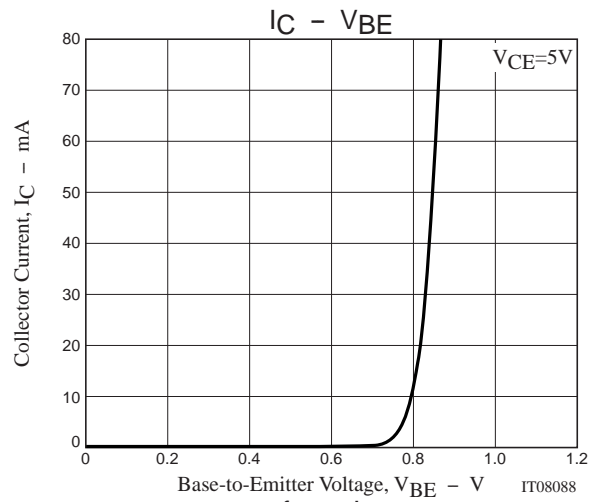
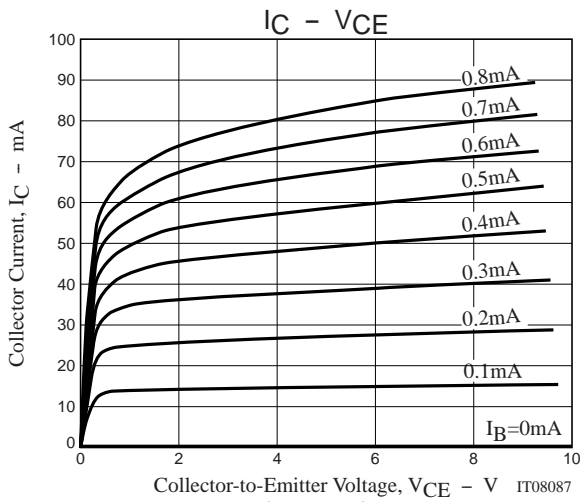
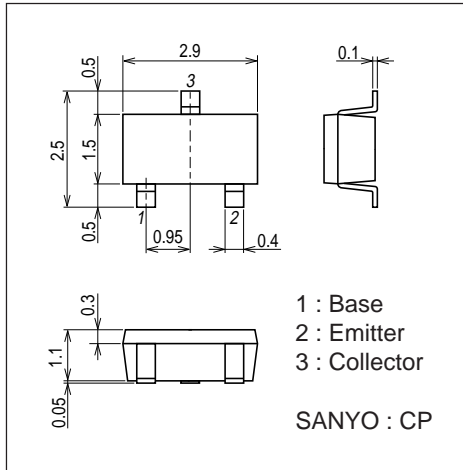

15GN03CA

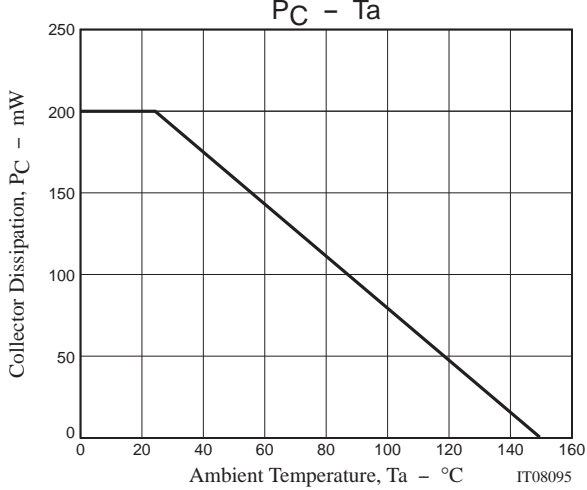
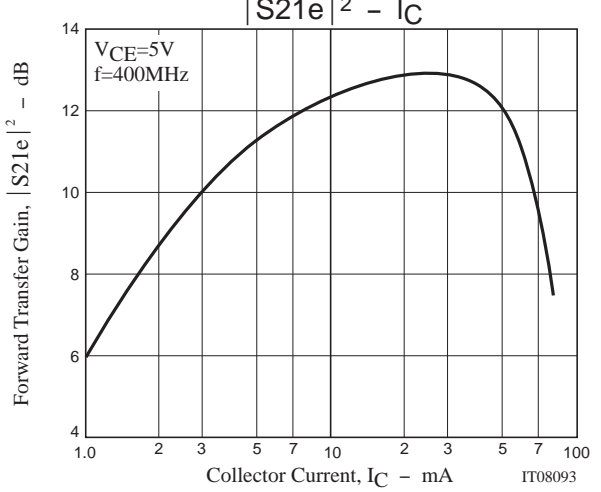
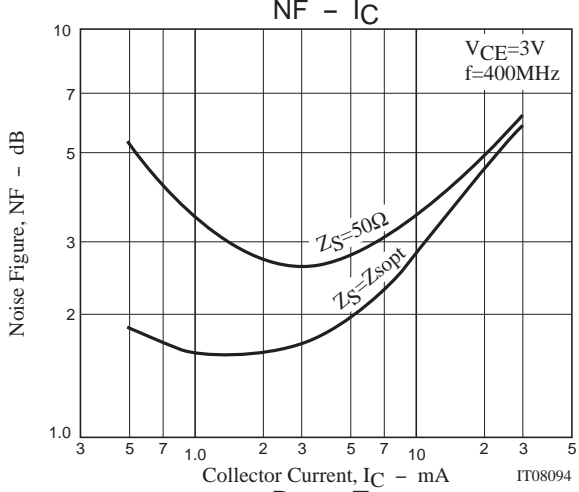
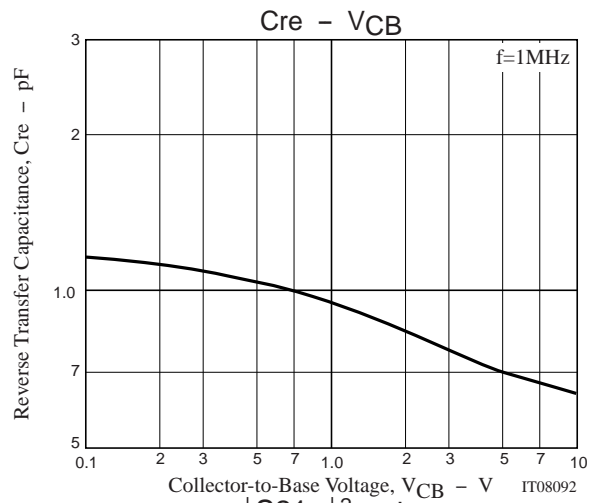
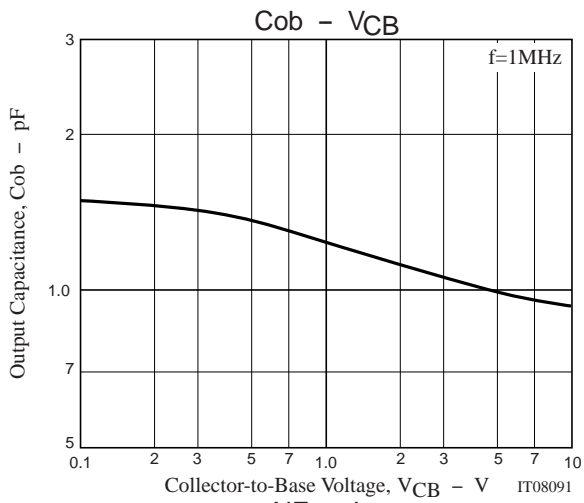

15GN03CA

S Parameters (Common emitter)

$V_{CE}=5V, I_C=1mA, Z_O=50\Omega$

Freq(MHz)	$ S_{11} $	$\angle S_{11}$	$ S_{21} $	$\angle S_{21}$	$ S_{12} $	$\angle S_{12}$	$ S_{22} $	$\angle S_{22}$
100	0.918	-34.17	3.328	154.00	0.040	67.14	0.963	-9.32
200	0.816	-63.46	2.833	133.91	0.063	50.52	0.897	-15.61
300	0.719	-87.48	2.349	118.47	0.075	39.90	0.847	-19.59
400	0.650	-106.66	1.974	106.31	0.081	33.68	0.816	-22.72
500	0.603	-123.45	1.709	96.50	0.081	30.41	0.795	-25.65
600	0.579	-137.17	1.492	88.62	0.078	30.45	0.785	-28.56
700	0.562	-149.31	1.328	81.55	0.074	30.61	0.779	-31.42
800	0.557	-159.59	1.197	75.34	0.070	34.97	0.777	-34.68
900	0.557	-168.64	1.094	70.12	0.068	41.63	0.773	-38.02
1000	0.560	-176.38	1.003	65.13	0.066	50.34	0.773	-41.22

$V_{CE}=5V, I_C=3mA, Z_O=50\Omega$

Freq(MHz)	$ S_{11} $	$\angle S_{11}$	$ S_{21} $	$\angle S_{21}$	$ S_{12} $	$\angle S_{12}$	$ S_{22} $	$\angle S_{22}$
100	0.799	-55.14	7.483	141.00	0.033	59.88	0.886	-14.45
200	0.641	-93.26	5.412	118.03	0.047	44.28	0.773	-18.84
300	0.553	-118.80	4.036	104.19	0.050	40.23	0.719	-21.00
400	0.512	-136.73	3.182	94.58	0.052	40.73	0.693	-22.61
500	0.492	-150.89	2.627	86.95	0.055	44.74	0.683	-24.93
600	0.488	-161.99	2.244	80.86	0.056	49.28	0.677	-27.44
700	0.487	-171.08	1.958	75.25	0.059	55.44	0.675	-30.18
800	0.492	-178.68	1.749	70.37	0.063	62.40	0.675	-33.31
900	0.502	174.60	1.575	65.89	0.068	67.82	0.674	-36.39
1000	0.508	168.93	1.433	61.61	0.078	74.10	0.677	-39.25

$V_{CE}=5V, I_C=5mA, Z_O=50\Omega$

Freq(MHz)	$ S_{11} $	$\angle S_{11}$	$ S_{21} $	$\angle S_{21}$	$ S_{12} $	$\angle S_{12}$	$ S_{22} $	$\angle S_{22}$
100	0.703	-69.63	10.162	132.63	0.030	54.51	0.821	-16.94
200	0.550	-109.80	6.625	110.25	0.037	43.19	0.704	-19.31
300	0.490	-133.75	4.733	98.16	0.041	44.91	0.660	-20.36
400	0.464	-149.68	3.666	89.82	0.045	49.05	0.643	-21.83
500	0.458	-161.66	3.003	83.25	0.049	56.14	0.635	-23.97
600	0.460	-170.95	2.537	77.83	0.054	60.18	0.632	-26.46
700	0.465	-178.51	2.212	72.71	0.058	65.91	0.631	-29.05
800	0.472	174.93	1.962	68.10	0.067	71.03	0.633	-32.06
900	0.482	169.11	1.764	64.09	0.075	76.57	0.634	-35.26
1000	0.491	164.18	1.602	59.88	0.085	78.96	0.635	-38.26

$V_{CE}=5V, I_C=10mA, Z_O=50\Omega$

Freq(MHz)	$ S_{11} $	$\angle S_{11}$	$ S_{21} $	$\angle S_{21}$	$ S_{12} $	$\angle S_{12}$	$ S_{22} $	$\angle S_{22}$
100	0.568	-91.34	13.492	121.50	0.022	51.19	0.729	-18.79
200	0.463	-130.04	7.837	102.18	0.030	50.01	0.628	-18.37
300	0.435	-149.86	5.435	92.29	0.035	56.54	0.598	-18.84
400	0.427	-162.69	4.153	85.23	0.041	59.99	0.587	-20.20
500	0.431	-171.77	3.374	79.57	0.047	67.05	0.586	-22.36
600	0.438	-179.07	2.842	74.63	0.055	70.37	0.585	-24.64
700	0.446	174.71	2.460	69.90	0.062	74.51	0.587	-27.44
800	0.457	169.18	2.181	65.54	0.072	78.16	0.588	-30.30
900	0.469	164.67	1.954	61.61	0.080	80.51	0.592	-33.49
1000	0.482	160.55	1.775	57.60	0.092	82.60	0.596	-36.43

15GN03CA

S Parameters (Common emitter)

$V_{CE}=5V, I_C=15mA, Z_O=50\Omega$

Freq(MHz)	$ S_{11} $	$\angle S_{11}$	$ S_{21} $	$\angle S_{21}$	$ S_{12} $	$\angle S_{12}$	$ S_{22} $	$\angle S_{22}$
100	0.506	-103.02	14.843	116.40	0.020	52.22	0.680	-19.13
200	0.433	-139.11	8.300	98.87	0.027	55.27	0.595	-17.41
300	0.418	-156.74	5.691	89.86	0.032	60.47	0.571	-17.79
400	0.416	-167.49	4.336	83.26	0.040	65.01	0.567	-19.20
500	0.423	-175.59	3.518	77.72	0.047	70.77	0.564	-21.38
600	0.434	177.94	2.949	72.99	0.056	75.36	0.566	-23.76
700	0.441	172.60	2.558	68.36	0.064	77.18	0.566	-26.43
800	0.454	167.70	2.257	64.14	0.073	80.34	0.573	-29.43
900	0.468	163.21	2.026	60.20	0.084	82.23	0.576	-32.58
1000	0.478	159.35	1.833	56.21	0.094	82.82	0.579	-35.40

$V_{CE}=5V, I_C=20mA, Z_O=50\Omega$

Freq(MHz)	$ S_{11} $	$\angle S_{11}$	$ S_{21} $	$\angle S_{21}$	$ S_{12} $	$\angle S_{12}$	$ S_{22} $	$\angle S_{22}$
100	0.473	-110.94	15.555	113.24	0.018	48.75	0.651	-18.99
200	0.420	-144.96	8.504	96.80	0.025	55.46	0.577	-16.75
300	0.412	-160.51	5.806	88.35	0.032	64.32	0.556	-16.94
400	0.412	-170.47	4.415	81.97	0.040	69.43	0.553	-18.38
500	0.423	-177.81	3.567	76.52	0.047	73.49	0.552	-20.62
600	0.434	176.33	2.998	72.06	0.054	76.85	0.554	-23.22
700	0.443	171.32	2.597	67.40	0.064	79.43	0.555	-25.76
800	0.457	166.61	2.289	62.99	0.075	80.21	0.562	-28.77
900	0.470	162.56	2.044	58.98	0.084	82.61	0.567	-31.92
1000	0.484	159.03	1.849	54.97	0.095	83.62	0.572	-34.90

$V_{CE}=5V, I_C=30mA, Z_O=50\Omega$

Freq(MHz)	$ S_{11} $	$\angle S_{11}$	$ S_{21} $	$\angle S_{21}$	$ S_{12} $	$\angle S_{12}$	$ S_{22} $	$\angle S_{22}$
100	0.444	-121.15	16.032	109.59	0.018	56.45	0.620	-18.33
200	0.414	-151.46	8.590	94.42	0.023	58.54	0.558	-15.68
300	0.413	-164.93	5.826	86.42	0.031	69.33	0.543	-15.93
400	0.418	-173.75	4.420	80.00	0.040	71.41	0.541	-17.58
500	0.429	179.87	3.560	74.72	0.048	75.89	0.545	-19.95
600	0.442	174.95	2.980	69.97	0.056	78.14	0.546	-22.37
700	0.454	170.06	2.575	65.31	0.067	79.78	0.550	-25.11
800	0.467	165.62	2.268	61.02	0.077	81.97	0.556	-27.94
900	0.485	161.83	2.027	57.14	0.086	83.95	0.563	-31.50
1000	0.497	158.27	1.829	53.02	0.096	84.97	0.570	-34.37

$V_{CE}=5V, I_C=50mA, Z_O=50\Omega$

Freq(MHz)	$ S_{11} $	$\angle S_{11}$	$ S_{21} $	$\angle S_{21}$	$ S_{12} $	$\angle S_{12}$	$ S_{22} $	$\angle S_{22}$
100	0.436	-135.54	15.112	105.16	0.016	53.23	0.591	-16.61
200	0.431	-160.16	7.915	91.13	0.021	62.83	0.547	-14.06
300	0.439	-170.89	5.332	83.37	0.030	71.57	0.538	-15.05
400	0.447	-177.86	4.022	77.04	0.039	75.43	0.538	-16.92
500	0.462	176.77	3.231	71.43	0.046	77.82	0.543	-19.30
600	0.477	172.03	2.708	66.71	0.057	81.23	0.548	-22.35
700	0.490	167.59	2.318	61.92	0.065	82.45	0.553	-25.43
800	0.507	163.59	2.037	57.52	0.076	84.13	0.559	-28.69
900	0.523	159.90	1.813	53.42	0.087	86.15	0.566	-32.45
1000	0.539	156.32	1.629	49.36	0.099	87.07	0.573	-35.73

- SANYO Semiconductor Co.,Ltd. assumes no responsibility for equipment failures that result from using products at values that exceed, even momentarily, rated values (such as maximum ratings, operating condition ranges, or other parameters) listed in products specifications of any and all SANYO Semiconductor Co.,Ltd. products described or contained herein.
- SANYO Semiconductor Co.,Ltd. strives to supply high-quality high-reliability products, however, any and all semiconductor products fail or malfunction with some probability. It is possible that these probabilistic failures or malfunction could give rise to accidents or events that could endanger human lives, trouble that could give rise to smoke or fire, or accidents that could cause damage to other property. When designing equipment, adopt safety measures so that these kinds of accidents or events cannot occur. Such measures include but are not limited to protective circuits and error prevention circuits for safe design, redundant design, and structural design.
- In the event that any or all SANYO Semiconductor Co.,Ltd. products described or contained herein are controlled under any of applicable local export control laws and regulations, such products may require the export license from the authorities concerned in accordance with the above law.
- No part of this publication may be reproduced or transmitted in any form or by any means, electronic or mechanical, including photocopying and recording, or any information storage or retrieval system, or otherwise, without the prior written consent of SANYO Semiconductor Co.,Ltd.
- Any and all information described or contained herein are subject to change without notice due to product/technology improvement, etc. When designing equipment, refer to the "Delivery Specification" for the SANYO Semiconductor Co.,Ltd. product that you intend to use.
- Information (including circuit diagrams and circuit parameters) herein is for example only; it is not guaranteed for volume production.
- Upon using the technical information or products described herein, neither warranty nor license shall be granted with regard to intellectual property rights or any other rights of SANYO Semiconductor Co.,Ltd. or any third party. SANYO Semiconductor Co.,Ltd. shall not be liable for any claim or suits with regard to a third party's intellectual property rights which has resulted from the use of the technical information and products mentioned above.

This catalog provides information as of October, 2008. Specifications and information herein are subject to change without notice.