

**Features**

- LARGE SIZE.
- 4.0 INCH DIGIT HEIGHT.
- LOW CURRENT OPERATION.
- EXCELLENT CHARACTER APPEARANCE.
- HIGH LIGHT OUTPUT.
- EASY MOUNTING ON P.C. BOARDS OR SOCKETS.
- I.C. COMPATIBLE.
- MECHANICALLY RUGGED.
- STANDARD : GRAY FACE, WHITE SEGMENT.
- RoHS COMPLIANT.

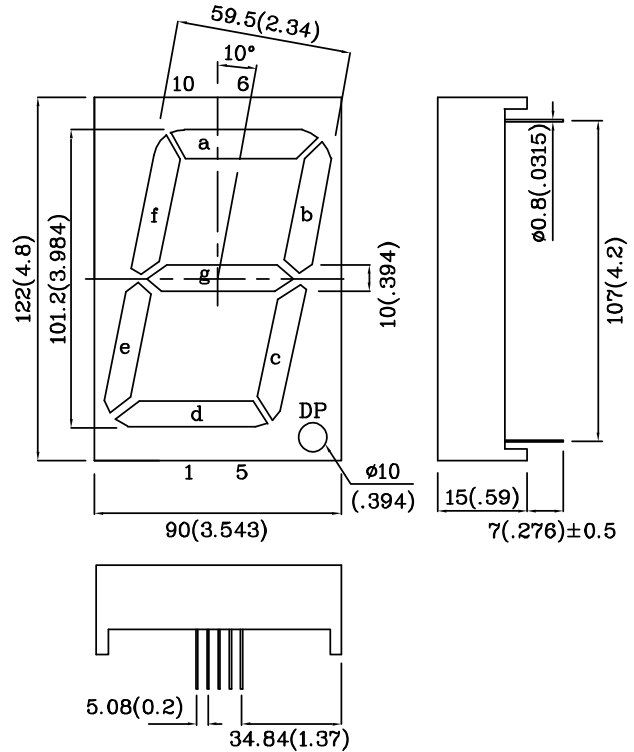
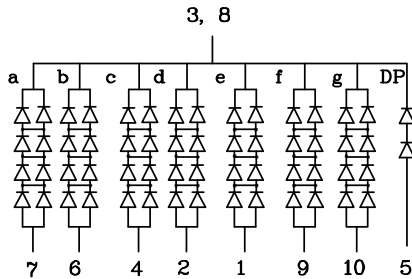

Notes:

1. All dimensions are in millimeters (inches).
2. Tolerance is  $\pm 0.25(0.01")$  unless otherwise noted.
3. Specifications are subject to change without notice.

Absolute maximum ratings (TA=25°C)		UR (GaAsP/GaP)	Unit
Reverse Voltage Per Segment Or (Dp)	V <sub>R</sub>	20 (10)	V
Forward Current Per Segment Or (Dp)	I <sub>F</sub>	60 (30)	mA
Forward Current (Peak) Per Segment Or (Dp) 1/10 Duty Cycle 0.1ms Pulse Width	i <sub>FS</sub>	320 (160)	mA
Power Dissipation Per Segment Or (Dp)	P <sub>T</sub>	600 (150)	mW
Operating Temperature	T <sub>A</sub>	-40 ~ +85	°C
Storage Temperature	T <sub>stg</sub>	-40 ~ +85	
Lead Solder Temperature [2mm Below Package Base]	260°C For 3~5 Seconds		

Operating Characteristics (TA=25°C)		UR (GaAsP/GaP)	Unit
Forward Voltage (Typ.) Per Segment Or (Dp) (I <sub>F</sub> =10mA)	V <sub>F</sub>	7.6 (3.8)	V
Forward Voltage (Max.) Per Segment Or (Dp) (I <sub>F</sub> =10mA)	V <sub>F</sub>	10.0 (5.0)	V
Reverse Current Per Segment Or (Dp) (Max.) (V <sub>R</sub> =20(10)V)	I <sub>R</sub>	20 (10)	uA
Wavelength Of Peak Emission (Typ.) (I <sub>F</sub> =10mA)	λ <sub>P</sub>	627	nm
Wavelength Of Dominant Emission (Typ.) (I <sub>F</sub> =10mA)	λ <sub>D</sub>	625	nm
Spectral Line Full Width At Half-Maximum (Typ.) (I <sub>F</sub> =10mA)	Δλ	45	nm
Capacitance (Typ.) (V <sub>F</sub> =0V, f=1MHz)	C	15	pF

Part Number	Emitting Color	Emitting Material	Luminous Intensity (I <sub>F</sub> =10mA) ucd		Wavelength nm λ <sub>P</sub>	Description
			min.	typ.		
DUR100C	Red	GaAsP/GaP	12000	43990	627	Common Cathode, Rt. Hand Decimal

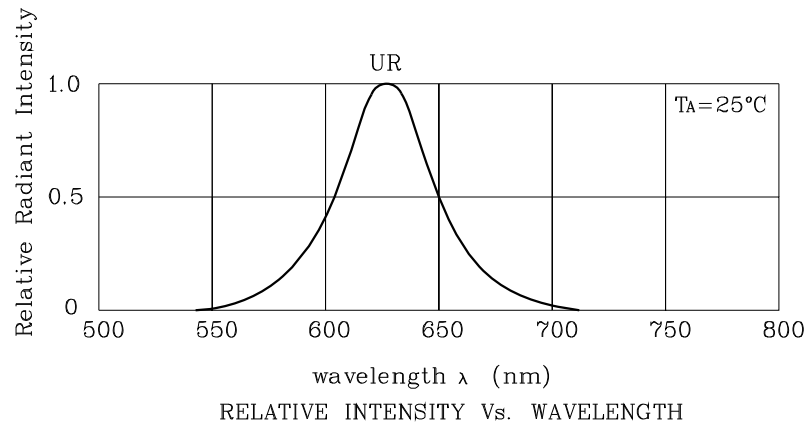

❖ UR

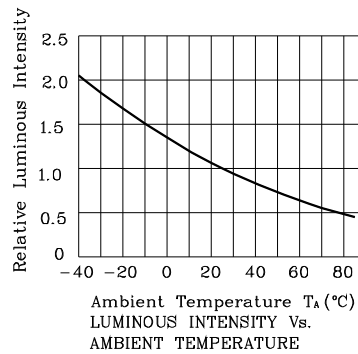
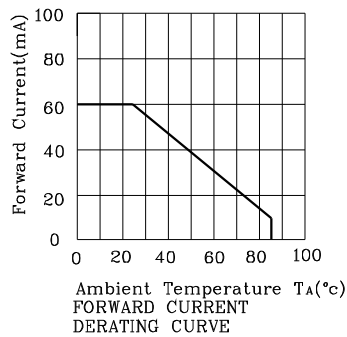
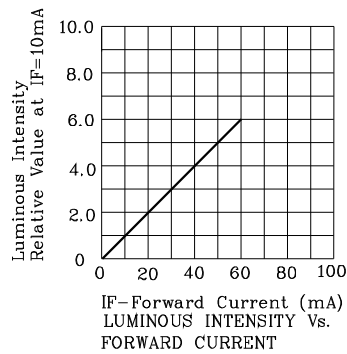
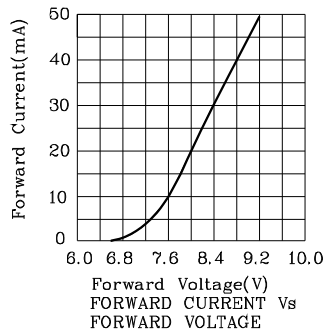

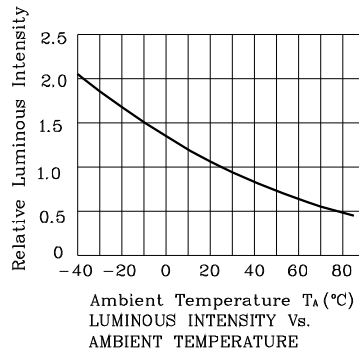
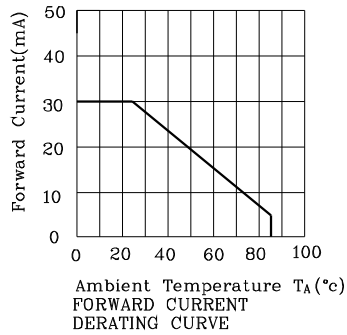
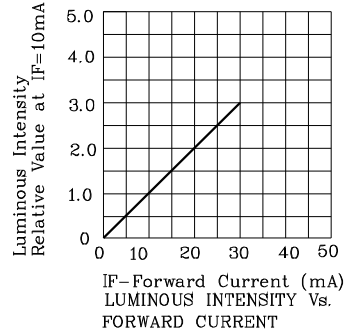
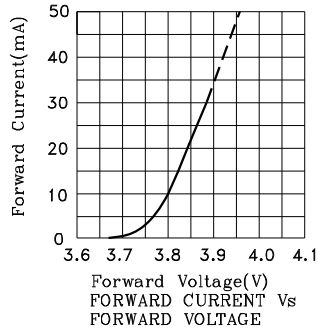

**DUR100C**

Wave Soldering Profile For Lead-free Through-hole LED.

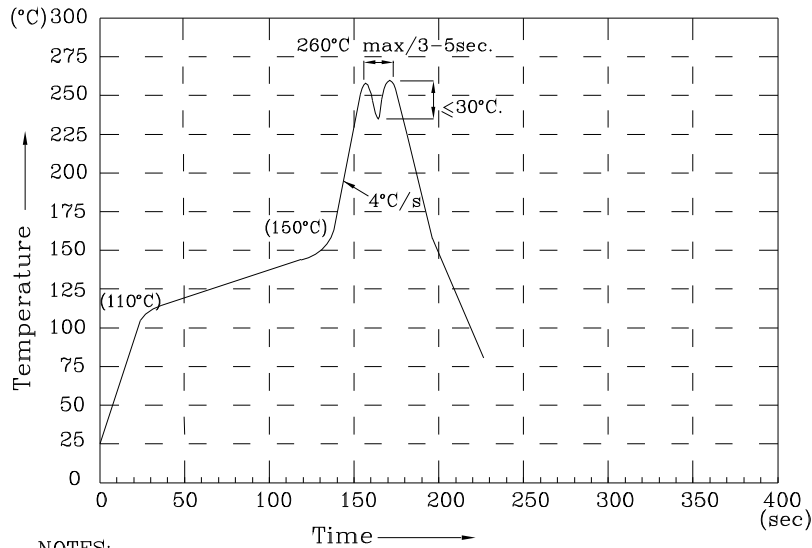

NOTES:

- 1.Recommend the wave temperature 245°C~260°C.The maximum soldering temperature should be less than 260°C.
- 2.Do not apply stress on epoxy resins when temperature is over 85 degree°C.
- 3.The soldering profile apply to the lead free soldering (Sn/Cu/Ag alloy).
- 4.No more than once.

Remarks:

If special sorting is required (e.g. binning based on forward voltage, Luminous intensity / luminous flux, or wavelength), the typical accuracy of the sorting process is as follows:

1. Wavelength: +/-1nm
2. Luminous intensity / luminous flux: +/-15%
3. Forward Voltage: +/-0.1V

Note: Accuracy may depend on the sorting parameters.

**PACKING & LABEL SPECIFICATIONS**

**DUR100C**

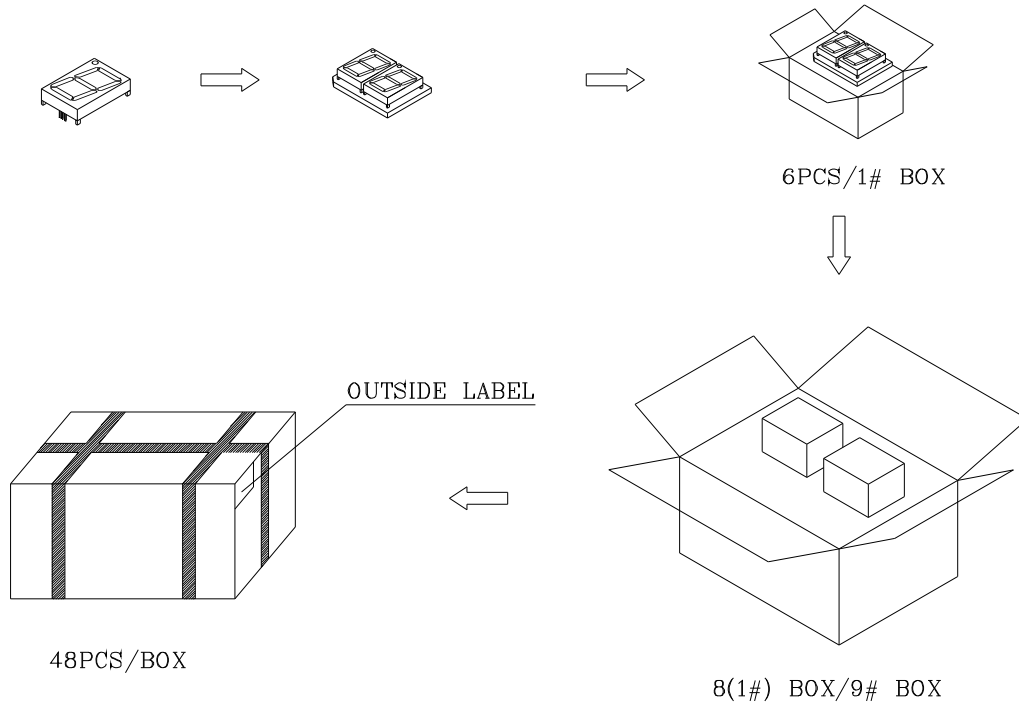

Inside LABEL Paste On The IC-tube

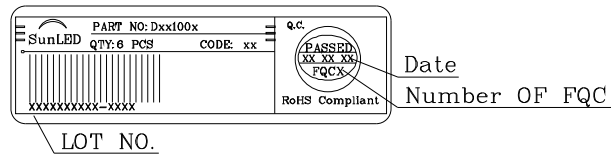

Outside LABEL Paste On The Box

