

Features

- 0.25 INCH DIGIT HEIGHT.
- LOW CURRENT OPERATION.
- EXCELLENT CHARACTER APPEARANCE.
- EASY MOUNTING ON P.C. BOARDS OR SOCKETS.
- I.C. COMPATIBLE.
- CATEGORIZED FOR LUMINOUS INTENSITY.
- MECHANICALLY RUGGED.
- STANDARD : GRAY FACE, WHITE SEGMENT.
- RoHS COMPLIANT.

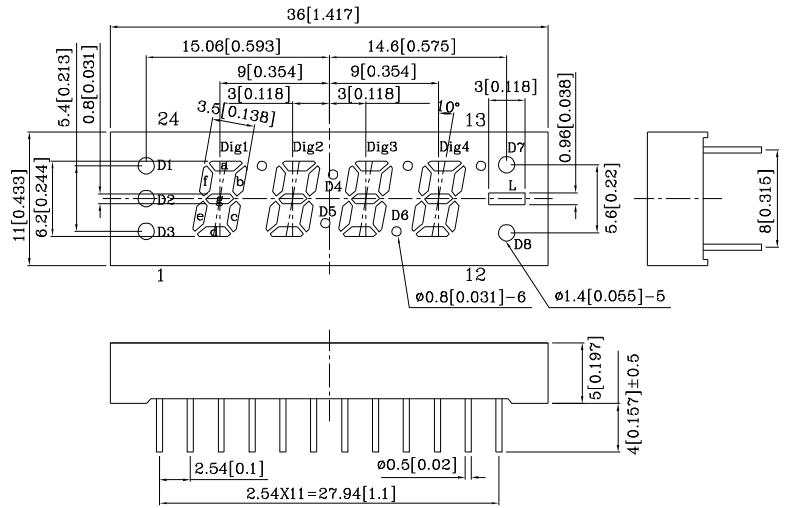
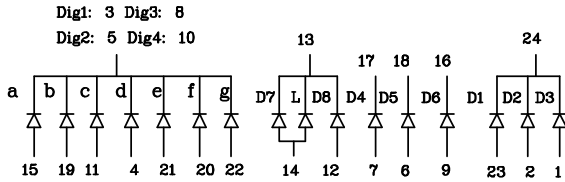

Notes:

1. All dimensions are in millimeters (inches).
2. Tolerance is ± 0.25(0.01") unless otherwise noted.
3. Specifications are subject to change without notice.

| Absolute Maximum Ratings (TA=25°C) | | UR (GaAsP/ GaP) | Unit |
|---|--|-----------------------|-----------------------|
| Reverse Voltage | Dig1'8,'Dig2'8',Dig3'8',Di g4'8' D1,D2,D3,D4,D5,D6,D8 | VR | 5 |
| | D7,L | | |
| Forward Current | Dig1'8,'Dig2'8',Dig3'8',Di g4'8' D1,D2,D3,D4,D5,D6,D8 | IF | 30 |
| | D7,L | | 60 |
| Forward Current (Peak) 1/10 Duty Cycle 0.1ms Pulse Width | Dig1'8,'Dig2'8',Dig3'8',Di g4'8' D1,D2,D3,D4,D5,D6,D8 | iFS | 160 |
| | D7,L | | 320 |
| Power Dissipation | Dig1'8,'Dig2'8',Dig3'8',Di g4'8' D1,D2,D3 ,D4,D5,D6,D8 | PT | 75 |
| | D7,L | | 150 |
| Operating Temperature | TA | | -40 ~ +85 |
| Storage Temperature | Tstg | | -40 ~ +85 |
| Lead Solder Temperature [2mm Below Package Base] | | | 260°C For 3~5 Seconds |

| Operating Characteristics (TA=25°C) | | UR (GaAsP/ GaP) | Unit |
|--|---|-----------------------|------|
| Forward Volt- age (Typ.) (IF=10mA) | Dig1'8,'Dig2'8',Dig3'8',D ig4'8' D1,D2,D3,D4,D5,D6,D8 | VF | 1.9 |
| | D7,L | | |
| Forward Volt- age (Max.) (IF=10mA) | Dig1'8,'Dig2'8',Dig3'8',D ig4'8' D1,D2,D3,D4,D5,D6,D8 | VF | 2.5 |
| | D7,L | | |
| Reverse Cur- rent (Max.) (VR=5V) | Dig1'8,'Dig2'8',Dig3'8',D ig4'8' D1,D2,D3,D4,D5,D6,D8 | IR | 10 |
| | D7,L | | 20 |
| Wavelength of Peak (Typ.) Emission (IF=10mA) | | λ P | 627 |
| Wavelength of Dominant Emission (Typ.) (IF=10mA) | | λ D | 625 |
| Spectral Line Full Width (Typ.) At Half-Maximum (IF=10mA) | | Δλ | 45 |
| Capacitance (Typ.) (VF=0V, f=1MHz) | | C | 15 |

| Part Number | Emitting Color | Emitting Material | Luminous Intensity (IF=10mA) ucd | | Wavelength nm λ P | Description |
|-------------|----------------|-------------------|-------------------------------------|------|---------------------------------|----------------|
| | | | min. | typ. | | |
| DUR06C4-A | Red | GaAsP/GaP | 1200 | 6390 | 627 | Common Cathode |

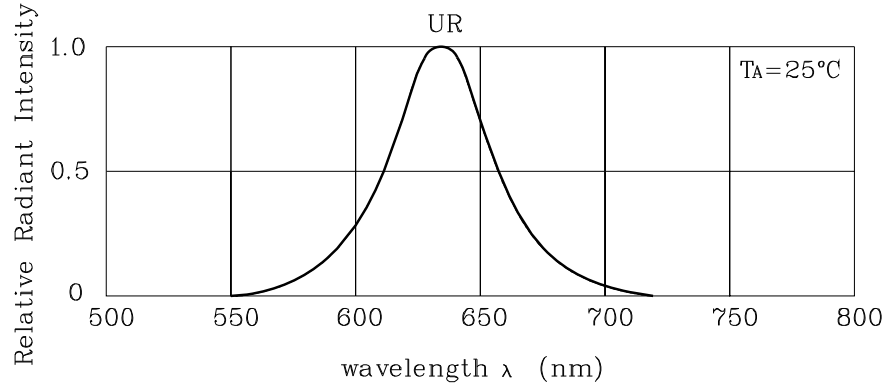

RELATIVE INTENSITY Vs. WAVELENGTH

❖ UR

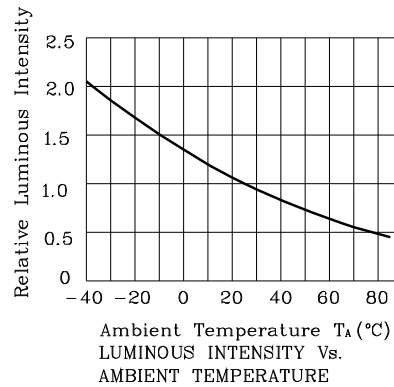
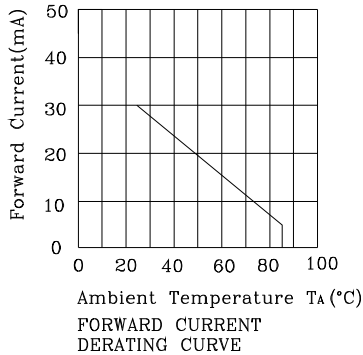
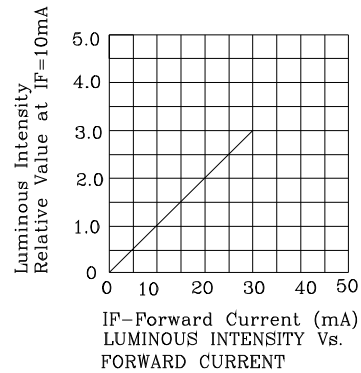
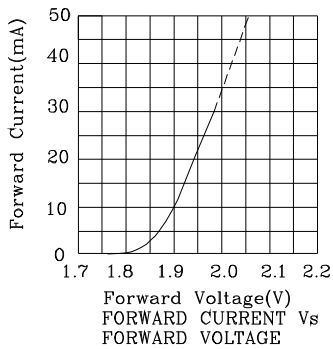

❖ UR

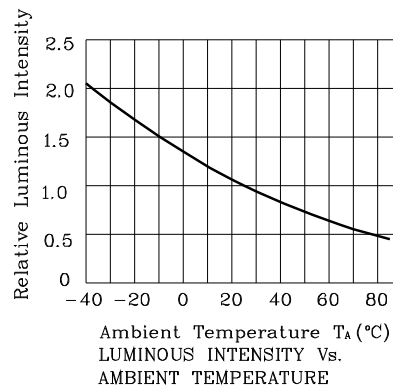
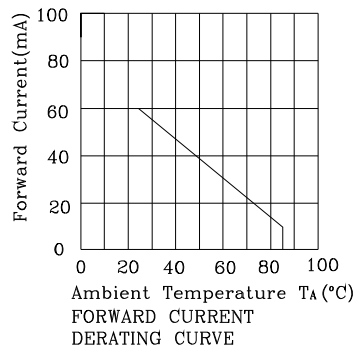
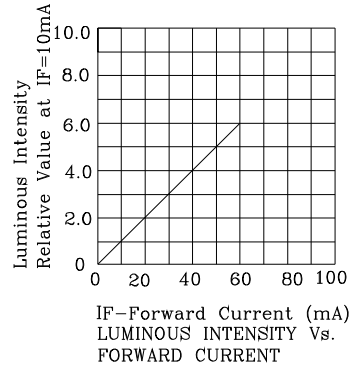
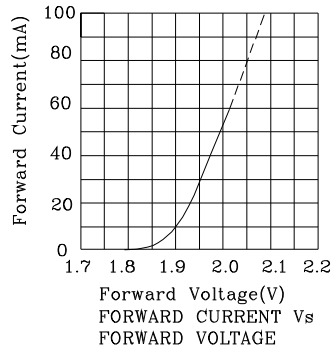

Wave Soldering Profile For Lead-free Through-hole LED.

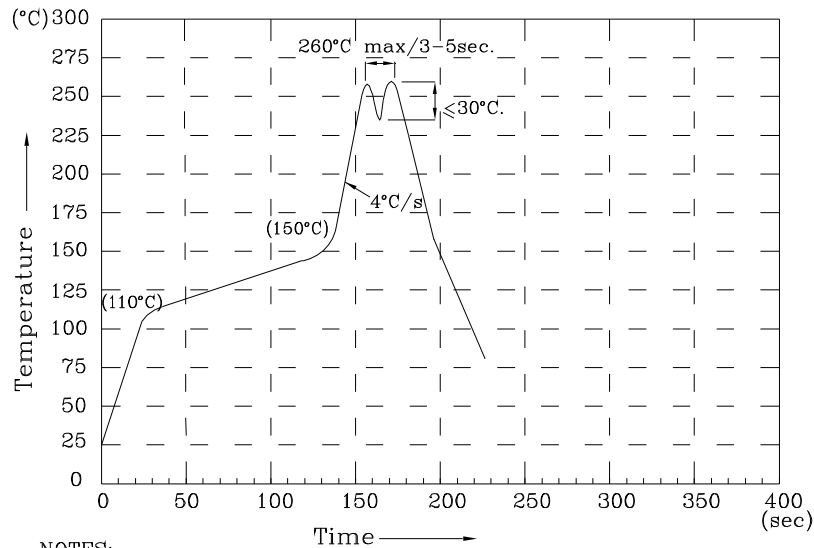

NOTES:

1. Recommend the wave temperature 245°C~260°C. The maximum soldering temperature should be less than 260°C.
2. Do not apply stress on epoxy resins when temperature is over 85 degree°C.
3. The soldering profile apply to the lead free soldering (Sn/Cu/Ag alloy).
4. No more than once.

Remarks:

If special sorting is required (e.g. binning based on forward voltage, luminous intensity/ luminous flux or wavelength), the typical accuracy of the sorting process is as follows:

1. Wavelength: +/-1nm
2. Luminous Intensity/ luminous flux: +/-15%
3. Forward Voltage: +/-0.1V

Note: Accuracy may depend on the sorting parameters.

PACKING & LABEL SPECIFICATIONS

DUR06C4-A

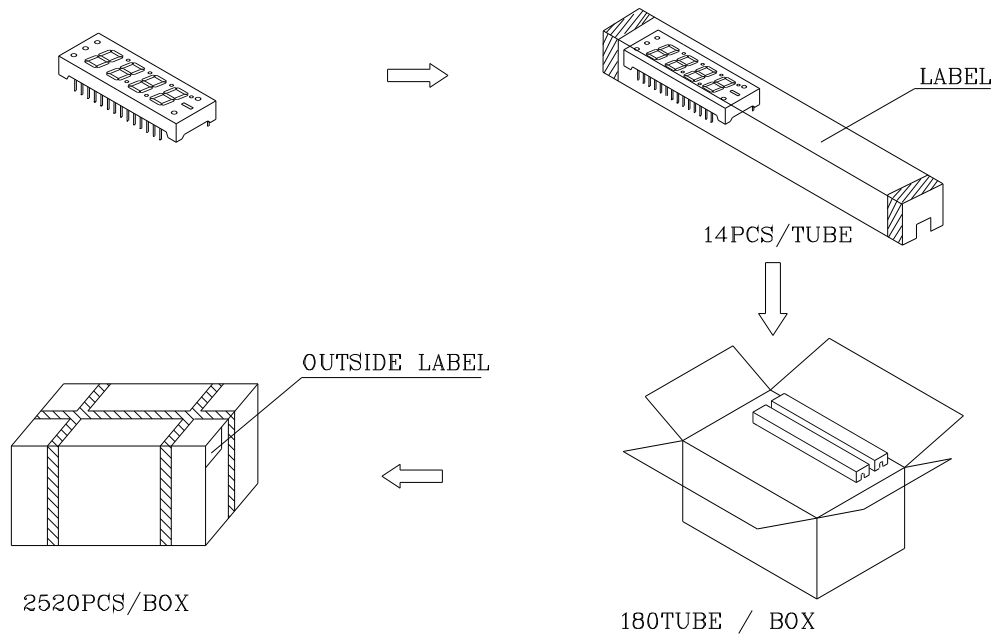

Inside LABEL Paste On The IC-tube

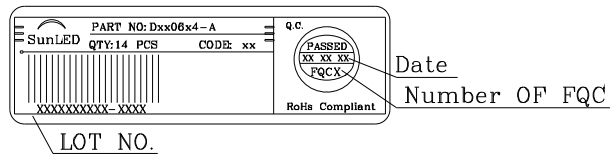

Outside LABEL Paste On The Box

