

1. CONFIGURATION & DIMENSIONS :

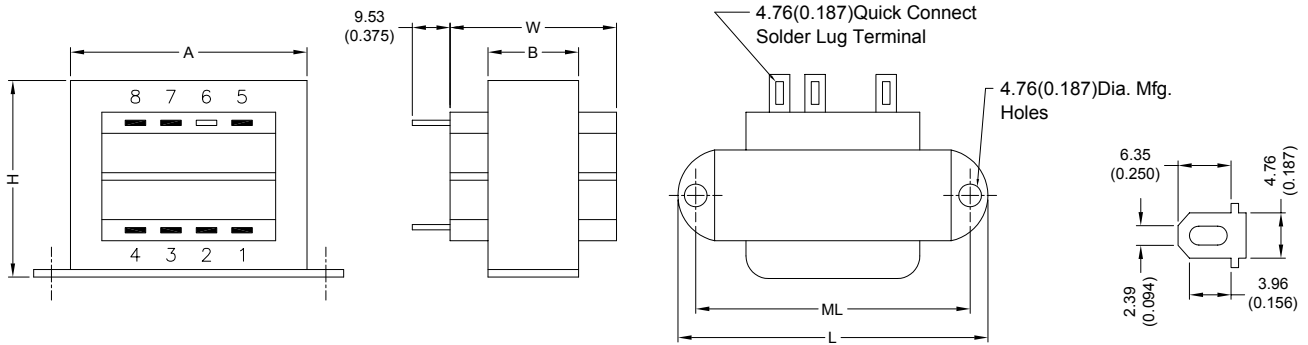

UNIT : mm (inch)

SIZE	VA	L	W	H	A	B	ML	gram
4	6	60.33 (2.375)	31.75 (1.250)	34.93 (1.375)	42.88 (1.688)	17.48 (0.688)	50.80 (2.000)	199.58

2. SCHEMATIC :

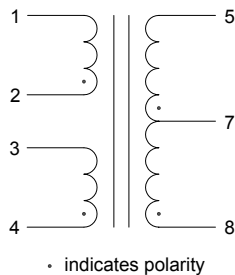

3. ELECTRICAL CHARACTERISTICS (@ 25°C) :

a. Primary Voltage	AC 115/230 V 50/60 Hz .
b. No Load Primary Current	Less Than 20mA / 25mA .
c. Secondary Voltage (±5%)	
Pin 5-8 C.T. Pin 7	AC 68.00 V / 67.60 V .
d. Secondary Load Current	0.11A .
e. Full Load Primary Current	Less Than 80mA / 45mA .
f. Full Load Secondary Voltage (±5%)	56.00V / 56.00V .
Pin 5-8 C.T. Pin 7	
g. DC Resistance	
Pin 1-2	Primary-1 = 257 Ohm .
Pin 3-4	Primary-2 = 317 Ohm .
Pin 5-7	Secondary-1 = 26.50 Ohm .
Pin 7-8	Secondary-2 = 26.50 Ohm .
h. Insulation Resistance	DC 500V 100Meg Ohm Of More .
i. Withstand Voltage (Hi-Pot)	AC 2500V 60Hz 1 Minutes .
j. Temperature Rise	Less Than 60 Deg C .
k. Core Size	EI-41 x 17.00 m/m .
l. Turns & Wire Gauge	
Primary-1 Pin 1-2	1600 Turns Diameter: 0.10 mm
Primary-2 Pin 3-4	1800 Turns Diameter: 0.10 mm
Secondary Pin 5-7-8	478 x 2 Turns Diameter: 0.18 mm



RoHS Compliant

NOTE : Specifications subject to change without notice. Please check our website for latest information.

25.02.2008



SUPERWORLD ELECTRONICS (S) PTE LTD