

# Preliminary Data Sheet

## Features

- For WLAN applications
- Usable bandwidth of 17 MHz
- Balanced or single-ended operation
- Ceramic Surface Mount Package (SMP)
- Small size

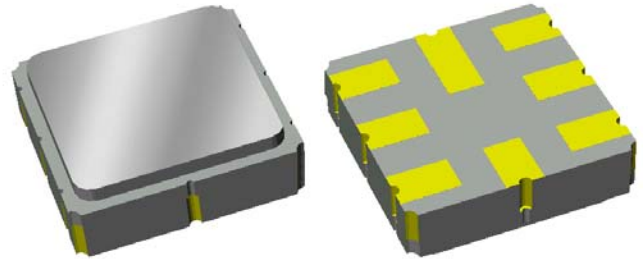

## Package

Surface Mount 3.80 x 3.80 x 1.27 mm

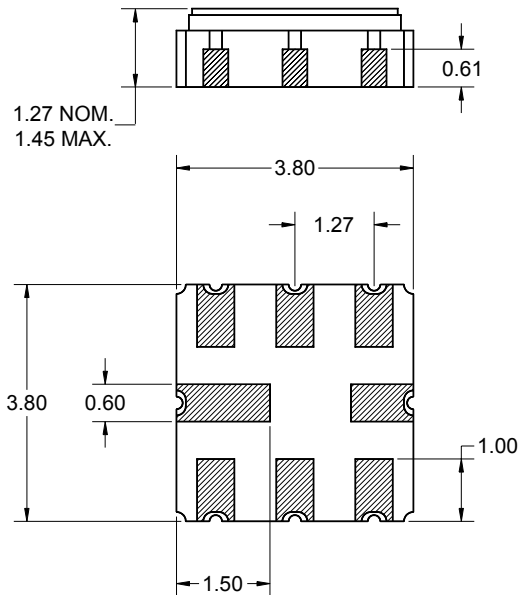

## Pin Configuration

Bottom View

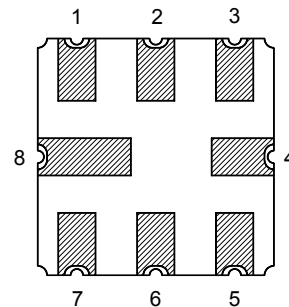

Pin No.	Description
2	Input
3	Input return
6	Output
7	Output return
1,4,5,8	Case ground

Dimensions shown are nominal in millimeters  
 All tolerances are  $\pm 0.15$ mm except overall  
 length and width  $\pm 0.10$ mm

Body:  $Al_2O_3$  ceramic  
 Lid: Kovar, Ni plated  
 Terminations: Au plating 0.5 - 1.0 $\mu$ m,  
 over a 2 - 6 $\mu$ m Ni plating

# Preliminary Data Sheet

## Electrical Specifications <sup>(1)</sup>

Operating Temperature Range: <sup>(2)</sup> -10 to +80 °C

Parameter <sup>(3)</sup>	Minimum	Typical	Maximum	Unit
<b>Center Frequency, <math>f_0</math></b>	-	374	-	MHz
<b>Maximum Insertion Loss</b> 367 - 381 MHz	-	9	10	dB
<b>Lower 3 dB Bandedge</b>	-	363.5	365.5	MHz
<b>Upper 3 dB Bandedge</b>	382.5	384.5	-	MHz
<b>Stop Band Rejection <sup>(4)</sup></b>				
274 - 331 MHz	45	50	-	dB
331 - 352 MHz	40	45	-	dB
352 - 357.5 MHz	30	35	-	dB
390.5 - 396 MHz	30	35	-	dB
396 - 404 MHz	35	41	-	dB
404 - 417 MHz	40	45	-	dB
417 - 474 MHz	40	45	-	dB
<b>Amplitude Variation <sup>(5)</sup></b> 367 - 381 MHz	-	0.75	1.0	dB
<b>Group Delay Variation <sup>(5)</sup></b> 367 - 381 MHz	-	40	100	nsec
<b>Triple Transit Suppression</b>	30	40	-	dB
<b>Source Impedance <sup>(6)</sup></b>	-	200	-	$\Omega$
<b>Load Impedance <sup>(6)</sup></b>	-	200	-	$\Omega$

### Notes:

1. All specifications are based on the test circuit shown below
2. In production, devices will be tested at room temperature to a guardbanded specification to ensure electrical compliance over temperature
3. Electrical margin has been built into the design to account for the variations due to temperature drift and manufacturing tolerances
4. All attenuation measured over the defined frequency range and referenced to minimum insertion loss
5. Total variation over the defined range
6. This is the optimum impedance in order to achieve the performance shown

### Test Circuit:

Actual matching values may vary due to PCB layout and parasitics

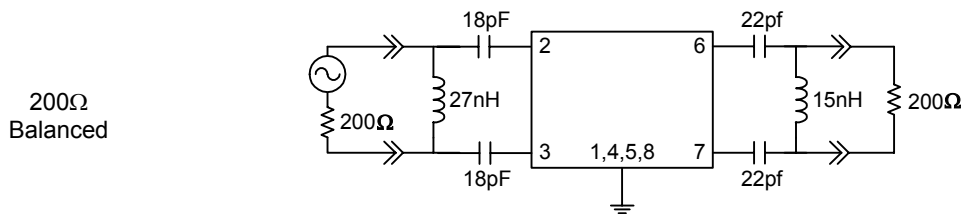

**Preliminary Data Sheet**

**Typical Performance (at +25°C)**

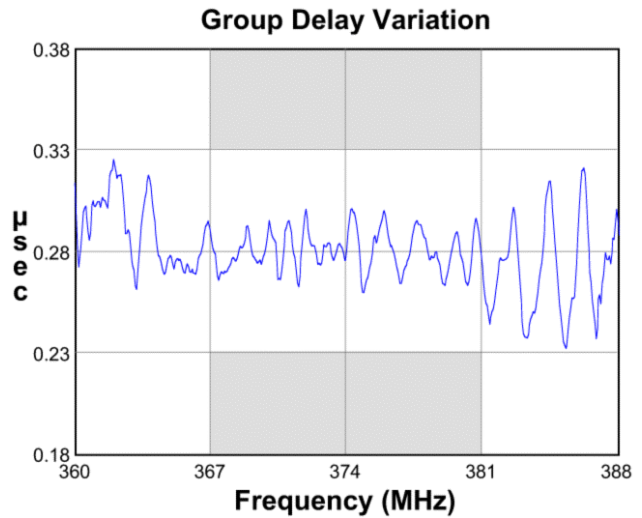
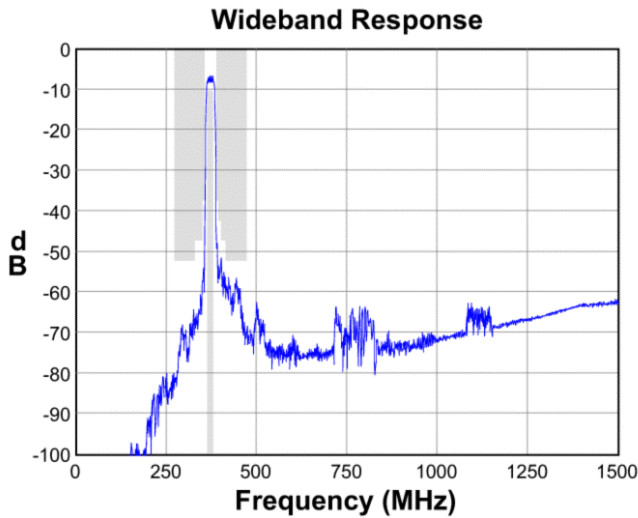
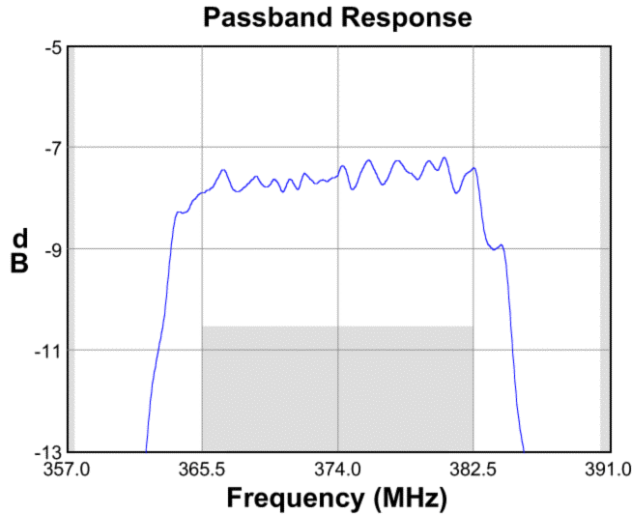
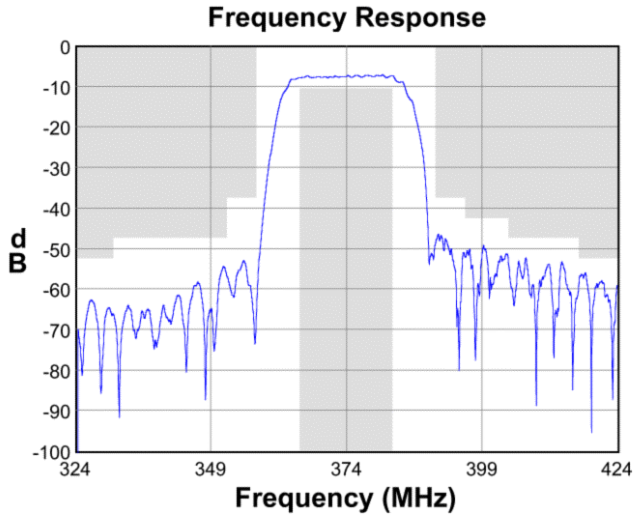

**Input Smith Chart**

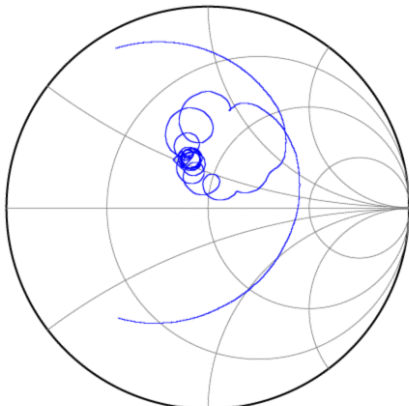

**Output Smith Chart**

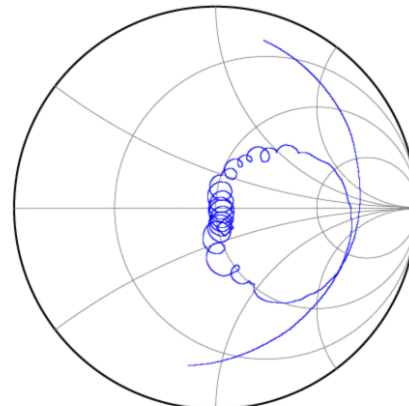

**Preliminary Data Sheet**

**Matching Schematics**

Actual matching values may vary due to PCB layout and parasitics

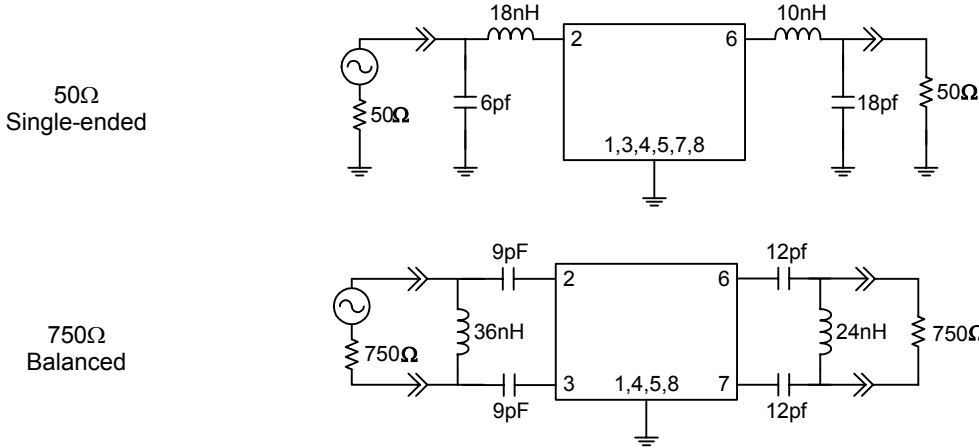

**Marking**

**PCB Footprint**

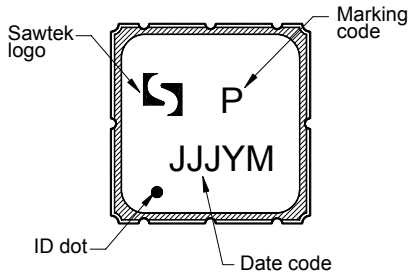

The date code consists of: JJJ = Julian day,  
Y = last digit of year, M = manufacturing site code

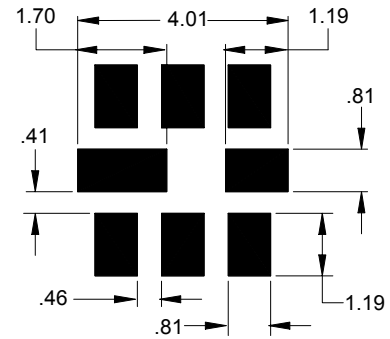

This footprint represents a recommendation only  
Dimensions shown are nominal in millimeters

**Tape and Reel**

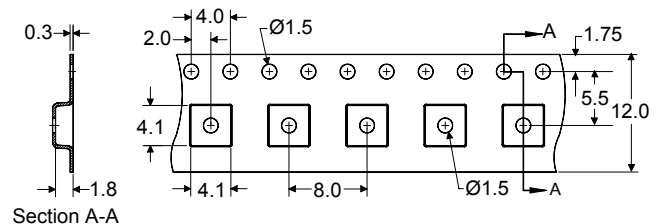
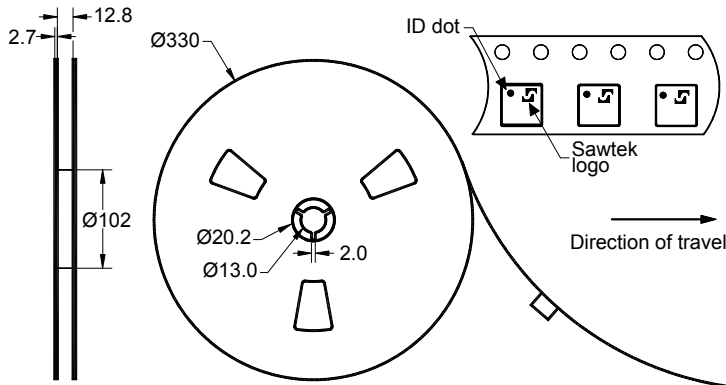

Dimensions shown are nominal in millimeters  
Packaging quantity: 4000 units/reel

# Preliminary Data Sheet

## Maximum Ratings

Parameter	Symbol	Minimum	Maximum	Unit
Operating Temperature Range	T	-10	+85	°C
Storage Temperature Range	T <sub>stg</sub>	-40	+85	°C
Input Power	P <sub>in</sub>	-	+10	dBm

### Warnings

- Electrostatic Sensitive Device (ESD) 
- Avoid ultrasonic exposure

## Links to Additional Technical Information

[PCB Layout Tips](#)

[Qualification Flowchart](#)

[Soldering Profile](#)

[S-Parameters](#)

[Other Technical Information](#)

Sawtek's liability is limited only to the Surface Acoustic Wave (SAW) component(s) described in this data sheet. Sawtek does not accept any liability for applications, processes, circuits or assemblies which are implemented using any Sawtek component described in this data sheet.

## Contact Information



PO Box 609501  
 Orlando, FL 32860-9501  
 USA

Phone: +1 (407) 886-8860  
 Fax: +1 (407) 886-7061  
 Email: [custservice@sawtek.com](mailto:custservice@sawtek.com)  
 Web: [www.sawtek.com](http://www.sawtek.com)

Or contact one of our worldwide network of [sales offices](#), [representatives](#) or [distributors](#)