

TOSHIBA Bipolar Linear Integrated Circuit Silicon Monolithic

TAR5S15~TAR5S50**Point Regulators (Low-Dropout Regulator)**

The TAR5Sxx Series is comprised of general-purpose bipolar single-power-supply devices incorporating a control pin which can be used to turn them ON/OFF.

Overtemperature and overcurrent protection circuits are built in to the devices' output circuit.

Features

- Low stand-by current
- Overtemperature/overcurrent protection
- Operation voltage range is wide.
- Maximum output current is high.
- Difference between input voltage and output voltage is low.
- Small package.
- Ceramic capacitors can be used.

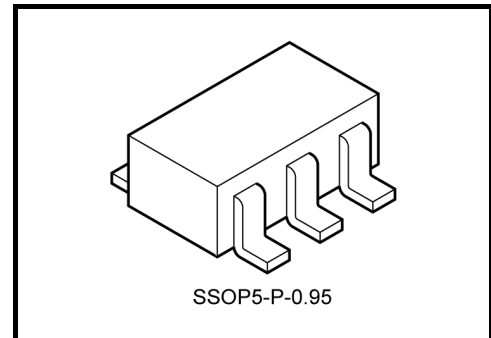

Weight: 0.014 g (typ.)

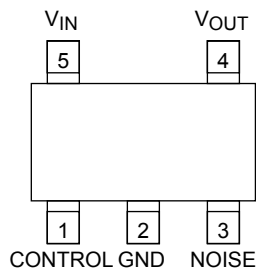
Pin Assignments (top view)

Overtemperature protection and overcurrent protection functions are not necessary guarantee of operating ratings below the absolute maximum ratings.

Do not use devices under conditions in which their absolute maximum ratings will be exceeded.

List of Products Number and Marking

Products No.	Marking	Products No.	Marking
TAR5S15	1V5	TAR5S33	3V3
TAR5S16	1V6	TAR5S34	3V4
TAR5S17	1V7	TAR5S35	3V5
TAR5S18	1V8	TAR5S36	3V6
TAR5S19	1V9	TAR5S37	3V7
TAR5S20	2V0	TAR5S38	3V8
TAR5S21	2V1	TAR5S39	3V9
TAR5S22	2V2	TAR5S40	4V0
TAR5S23	2V3	TAR5S41	4V1
TAR5S24	2V4	TAR5S42	4V2
TAR5S25	2V5	TAR5S43	4V3
TAR5S26	2V6	TAR5S44	4V4
TAR5S27	2V7	TAR5S45	4V5
TAR5S28	2V8	TAR5S46	4V6
TAR5S29	2V9	TAR5S47	4V7
TAR5S30	3V0	TAR5S48	4V8
TAR5S31	3V1	TAR5S49	4V9
TAR5S32	3V2	TAR5S50	5V0

Marking on the Product

Example: TAR5S30 (3.0 V output)

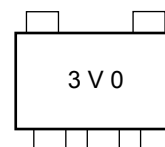

Absolute Maximum Ratings (Ta = 25°C)

Characteristics	Symbol	Rating	Unit
Supply voltage	V_{IN}	15	V
Output current	I_{OUT}	200	mA
Power dissipation	P_D	200 (Note 1)	mW
		380 (Note 2)	
Operation temperature range	T_{opr}	-40 to 85	°C
Storage temperature range	T_{stg}	-55 to 150	°C

Note: Using continuously under heavy loads (e.g. the application of high temperature/current/voltage and the significant change in temperature, etc.) may cause this product to decrease in the reliability significantly even if the operating conditions (i.e. operating temperature/current/voltage, etc.) are within the absolute maximum ratings and the operating ranges.

Please design the appropriate reliability upon reviewing the Toshiba Semiconductor Reliability Handbook ("Handling Precautions"/"Derating Concept and Methods") and individual reliability data (i.e. reliability test report and estimated failure rate, etc).

Note 1: Unit Rating

Note 2: Mounted on a glass epoxy circuit board of 30 × 30 mm. Pad dimension of 50 mm²

TAR5S15~TAR5S22

Electrical Characteristic (unless otherwise specified, $V_{IN} = V_{OUT} + 1\text{ V}$, $I_{OUT} = 50\text{ mA}$, $C_{IN} = 1\text{ }\mu\text{F}$, $C_{OUT} = 10\text{ }\mu\text{F}$, $C_{NOISE} = 0.01\text{ }\mu\text{F}$, $T_j = 25^\circ\text{C}$)

Characteristics	Symbol	Test Condition	Min	Typ.	Max	Unit
Output voltage	V_{OUT}	Please refer to the Output Voltage Accuracy table.				
Line regulation	Reg·line	$V_{OUT} + 1\text{ V} \leq V_{IN} \leq 15\text{ V}$, $I_{OUT} = 1\text{ mA}$	—	3	15	mV
Load regulation	Reg·load	$1\text{ mA} \leq I_{OUT} \leq 150\text{ mA}$	—	25	75	mV
Quiescent current	I_{B1}	$I_{OUT} = 0\text{ mA}$	—	170	—	μA
	I_{B2}	$I_{OUT} = 50\text{ mA}$	—	550	850	
Stand-by current	I_B (OFF)	$V_{CT} = 0\text{ V}$	—	—	0.1	μA
Output noise voltage	V_{NO}	$V_{IN} = V_{OUT} + 1\text{ V}$, $I_{OUT} = 10\text{ mA}$, $10\text{ Hz} \leq f \leq 100\text{ kHz}$, $C_{NOISE} = 0.01\text{ }\mu\text{F}$, $T_a = 25^\circ\text{C}$	—	30	—	μV_{rms}
Temperature coefficient	T_{CVO}	$-40^\circ\text{C} \leq T_{opr} \leq 85^\circ\text{C}$	—	100	—	ppm/ $^\circ\text{C}$
Input voltage	V_{IN}	—	2.4	—	15	V
Ripple rejection	R.R.	$V_{IN} = V_{OUT} + 1\text{ V}$, $I_{OUT} = 10\text{ mA}$, $C_{NOISE} = 0.01\text{ }\mu\text{F}$, $f = 1\text{ kHz}$, $V_{Ripple} = 500\text{ mV}_{p-p}$, $T_a = 25^\circ\text{C}$	—	70	—	dB
Control voltage (ON)	V_{CT} (ON)	—	1.5	—	V_{IN}	V
Control voltage (OFF)	V_{CT} (OFF)	—	—	—	0.4	V
Control current (ON)	I_{CT} (ON)	$V_{CT} = 1.5\text{ V}$	—	3	10	μA
Control current (OFF)	I_{CT} (OFF)	$V_{CT} = 0\text{ V}$	—	0	0.1	μA

TAR5S23~TAR5S50

Electrical Characteristic (unless otherwise specified, $V_{IN} = V_{OUT} + 1\text{ V}$, $I_{OUT} = 50\text{ mA}$, $C_{IN} = 1\text{ }\mu\text{F}$, $C_{OUT} = 10\text{ }\mu\text{F}$, $C_{NOISE} = 0.01\text{ }\mu\text{F}$, $T_j = 25^\circ\text{C}$)

Characteristics	Symbol	Test Condition	Min	Typ.	Max	Unit
Output voltage	V_{OUT}	Please refer to the Output Voltage Accuracy table.				
Line regulation	Reg·line	$V_{OUT} + 1\text{ V} \leq V_{IN} \leq 15\text{ V}$, $I_{OUT} = 1\text{ mA}$	—	3	15	mV
Load regulation	Reg·load	$1\text{ mA} \leq I_{OUT} \leq 150\text{ mA}$	—	25	75	mV
Quiescent current	I_{B1}	$I_{OUT} = 0\text{ mA}$	—	170	—	μA
	I_{B2}	$I_{OUT} = 50\text{ mA}$	—	550	850	
Stand-by current	I_B (OFF)	$V_{CT} = 0\text{ V}$	—	—	0.1	μA
Output noise voltage	V_{NO}	$V_{IN} = V_{OUT} + 1\text{ V}$, $I_{OUT} = 10\text{ mA}$, $10\text{ Hz} \leq f \leq 100\text{ kHz}$, $C_{NOISE} = 0.01\text{ }\mu\text{F}$, $T_a = 25^\circ\text{C}$	—	30	—	μV_{rms}
Dropout volatge	$V_{IN} - V_{OUT}$	$I_{OUT} = 50\text{ mA}$	—	130	200	mV
Temperature coefficient	T_{CVO}	$-40^\circ\text{C} \leq T_{opr} \leq 85^\circ\text{C}$	—	100	—	ppm/ $^\circ\text{C}$
Input voltage	V_{IN}	—	$V_{OUT} + 0.2\text{ V}$	—	15	V
Ripple rejection	R.R.	$V_{IN} = V_{OUT} + 1\text{ V}$, $I_{OUT} = 10\text{ mA}$, $C_{NOISE} = 0.01\text{ }\mu\text{F}$, $f = 1\text{ kHz}$, $V_{Ripple} = 500\text{ mV}_{p-p}$, $T_a = 25^\circ\text{C}$	—	70	—	dB
Control voltage (ON)	V_{CT} (ON)	—	1.5	—	V_{IN}	V
Control voltage (OFF)	V_{CT} (OFF)	—	—	—	0.4	V
Control current (ON)	I_{CT} (ON)	$V_{CT} = 1.5\text{ V}$	—	3	10	μA
Control current (OFF)	I_{CT} (OFF)	$V_{CT} = 0\text{ V}$	—	0	0.1	μA

Output Voltage Accuracy

($V_{IN} = V_{OUT} + 1\text{ V}$, $I_{OUT} = 50\text{ mA}$, $C_{IN} = 1\text{ }\mu\text{F}$, $C_{OUT} = 10\text{ }\mu\text{F}$, $C_{NOISE} = 0.01\text{ }\mu\text{F}$, $T_j = 25^\circ\text{C}$)

Product No.	Symbol	Min	Typ.	Max	Unit
TAR5S15	V _{OUT}	1.44	1.5	1.56	V
TAR5S16		1.54	1.6	1.66	
TAR5S17		1.64	1.7	1.76	
TAR5S18		1.74	1.8	1.86	
TAR5S19		1.84	1.9	1.96	
TAR5S20		1.94	2.0	2.06	
TAR5S21		2.04	2.1	2.16	
TAR5S22		2.14	2.2	2.26	
TAR5S23		2.24	2.3	2.36	
TAR5S24		2.34	2.4	2.46	
TAR5S25		2.43	2.5	2.57	
TAR5S26		2.53	2.6	2.67	
TAR5S27		2.63	2.7	2.77	
TAR5S28		2.73	2.8	2.87	
TAR5S29		2.83	2.9	2.97	
TAR5S30		2.92	3.0	3.08	
TAR5S31		3.02	3.1	3.18	
TAR5S32		3.12	3.2	3.28	
TAR5S33		3.21	3.3	3.39	
TAR5S34		3.31	3.4	3.49	
TAR5S35		3.41	3.5	3.59	
TAR5S36		3.51	3.6	3.69	
TAR5S37		3.6	3.7	3.8	
TAR5S38		3.7	3.8	3.9	
TAR5S39		3.8	3.9	4.0	
TAR5S40		3.9	4.0	4.1	
TAR5S41		3.99	4.1	4.21	
TAR5S42		4.09	4.2	4.31	
TAR5S43		4.19	4.3	4.41	
TAR5S44		4.29	4.4	4.51	
TAR5S45		4.38	4.5	4.62	
TAR5S46	4.48	4.6	4.72		
TAR5S47	4.58	4.7	4.82		
TAR5S48	4.68	4.8	4.92		
TAR5S49	4.77	4.9	5.03		
TAR5S50	4.87	5.0	5.13		

Application Note

1. Recommended Application Circuit

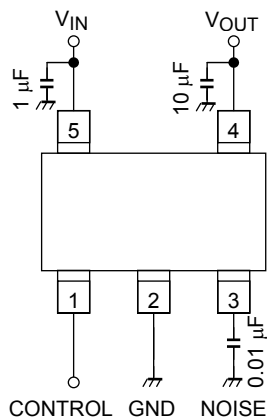

Control Level	Operation
HIGH	ON
LOW	OFF

The figure above shows the recommended configuration for using a point regulator. Insert a capacitor for stable input/output operation. If the control function is not to be used, Toshiba recommend that the control pin (pin 1) be connected to the VCC pin.

2. Power Dissipation

The power dissipation for board-mounted TAR5Sxx Series devices (rated at 380 mW) is measured using a board whose size and pattern are as shown below. When incorporating a device belonging to this series into your design, derate the power dissipation as far as possible by reducing the levels of parameters such as input voltage, output current and ambient temperature. Toshiba recommend that these devices should typically be derated to 70%~80% of their absolute maximum power dissipation value.

Thermal Resistance Evaluation Board

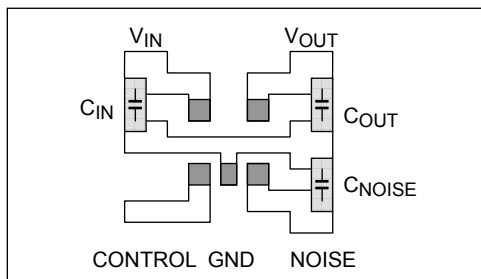

Circuit board material: glass epoxy,
 Circuit board dimension: 30 mm × 30 mm,
 Copper foil pad area: 50 mm² (t = 0.8 mm)

3. Ripple Rejection

The devices of the TAR5Sxx Series feature a circuit with an excellent ripple rejection characteristic. Because the circuit also features an excellent output fluctuation characteristic for sudden supply voltage drops, the circuit is ideal for use in the RF blocks incorporated in all mobile telephones.

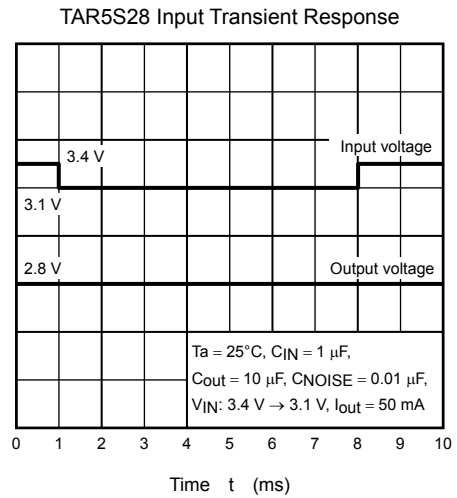
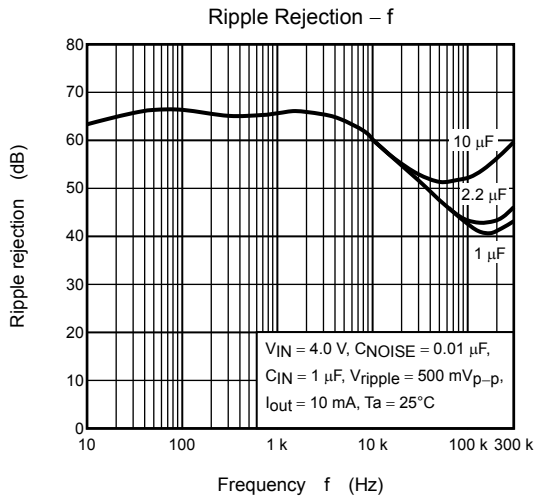

4. NOISE Pin

TAR5Sxx Series devices incorporate a NOISE pin to reduce output noise voltage. Inserting a capacitor between the NOISE pin and GND reduces output noise. To ensure stable operation, insert a capacitor of 0.0047 μF or more between the NOISE pin and GND.

The output voltage rise time varies according to the capacitance of the capacitor connected to the NOISE pin.

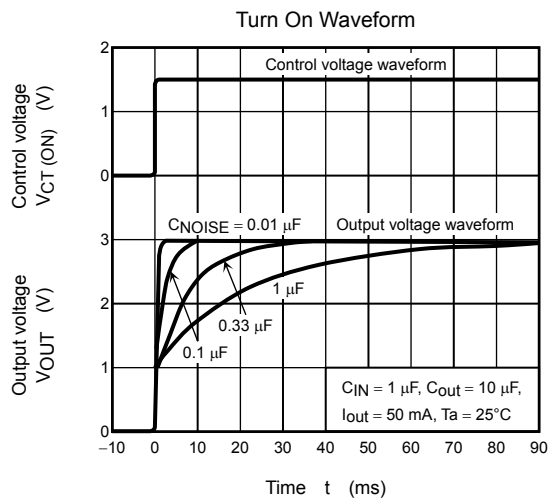
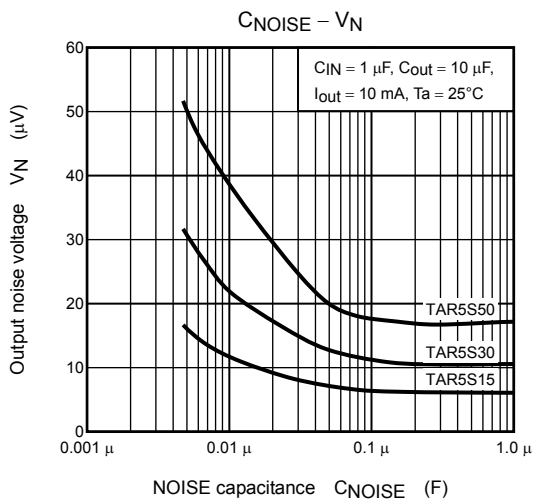

5. Example of Characteristics when Ceramic Capacitor is Used

Shown below is the stable operation area, where the output voltage does not oscillate, evaluated using a Toshiba evaluation circuit. The equivalent series resistance (ESR) of the output capacitor and output current determines this area. TAR5Sxx Series devices operate stably even when a ceramic capacitor is used as the output capacitor.

If a ceramic capacitor is used as the output capacitor and the ripple frequency is 30 kHz or more, the ripple rejection differs from that when a tantalum capacitor is used. This is shown below.

Toshiba recommend that users check that devices operate stably under the intended conditions of use.

Examples of safe operating area characteristics

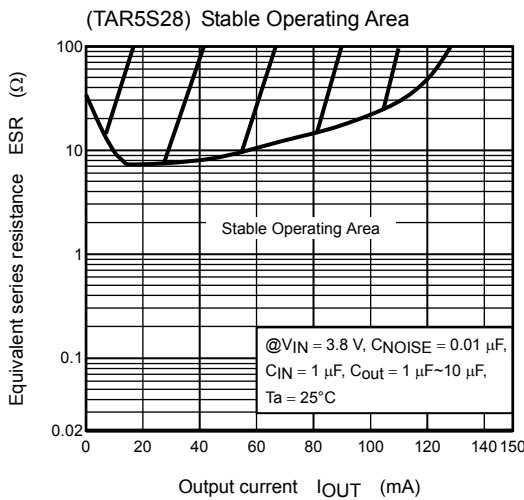
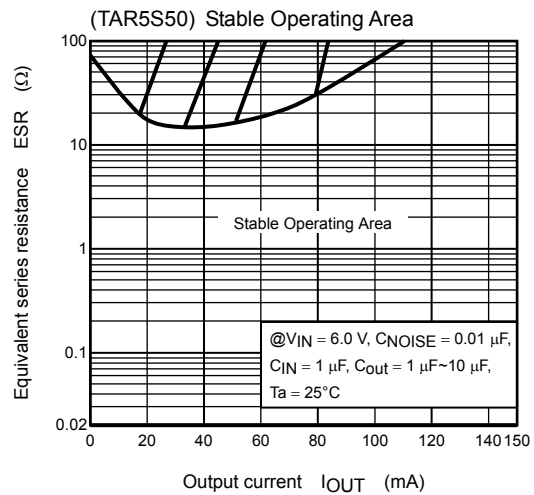
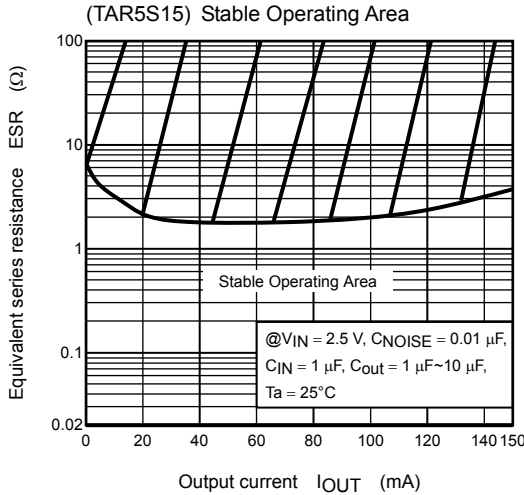

Evaluation Circuit for Stable Operating Area

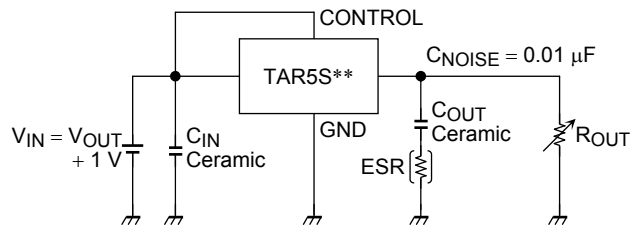

Capacitors used for evaluation
 Made by Murata CIN: GRM40B105K
 COUT: GRM40B105K/GRM40B106K

Ripple Rejection Characteristic (f = 10 kHz~300 kHz)

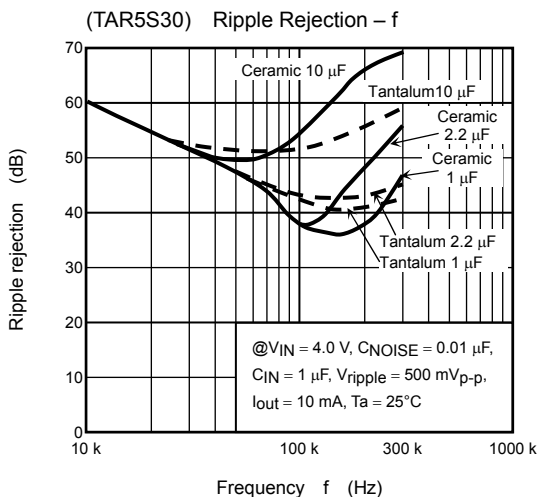

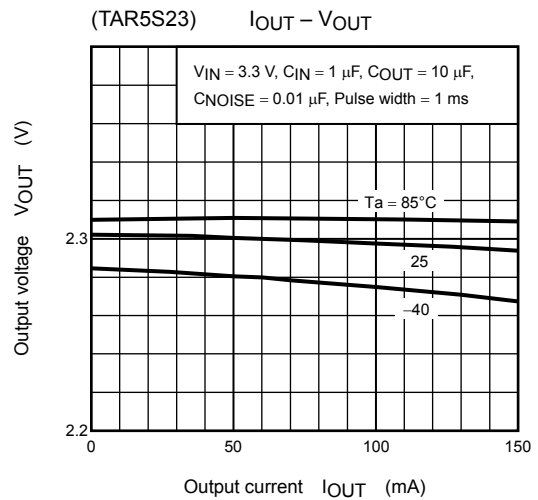
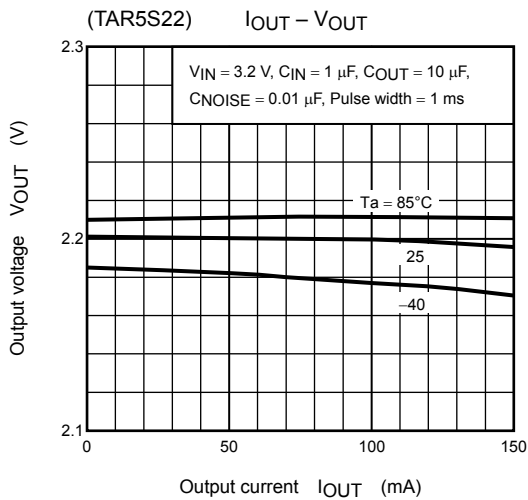
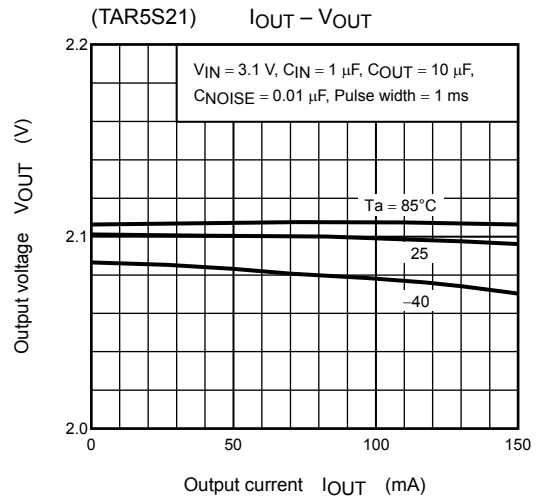
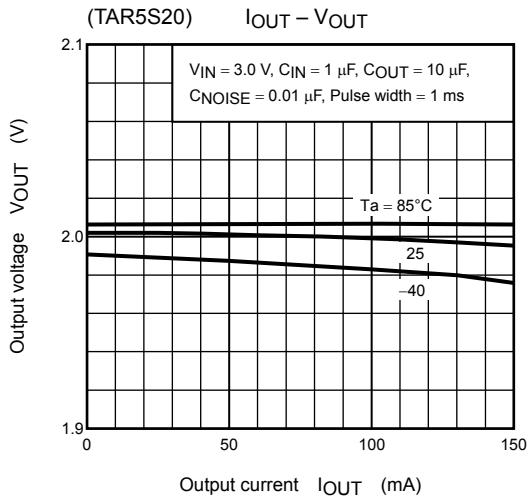
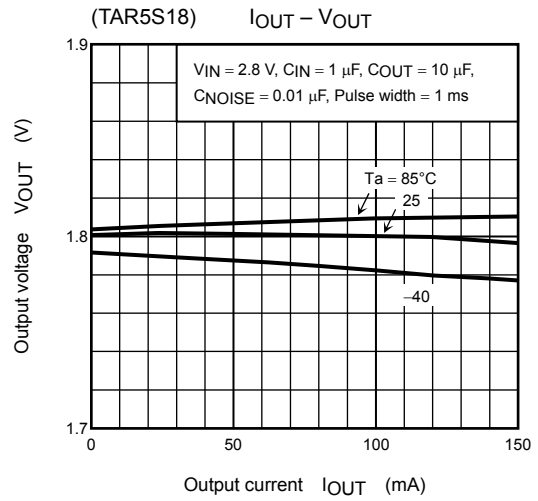
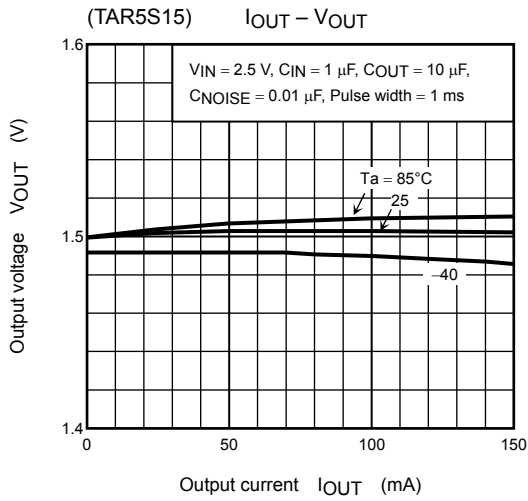

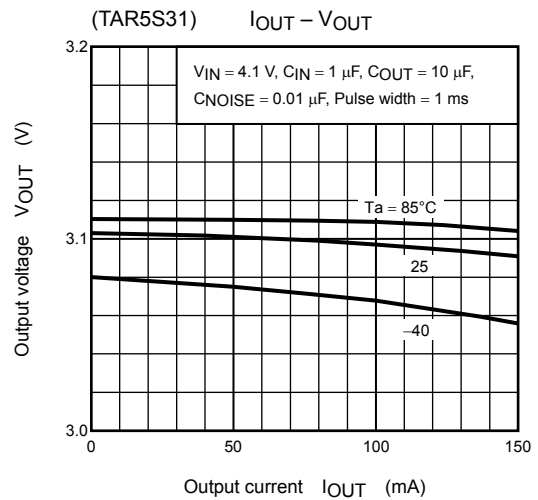
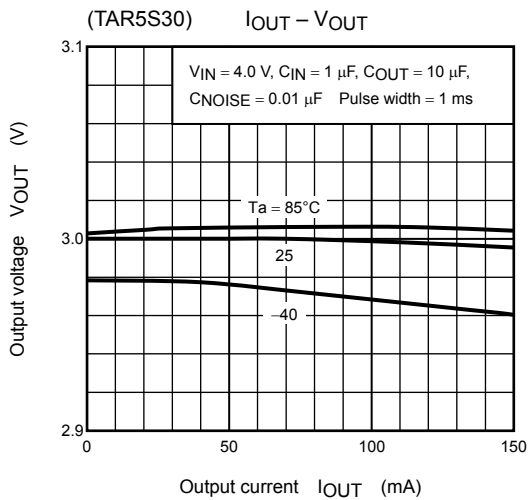
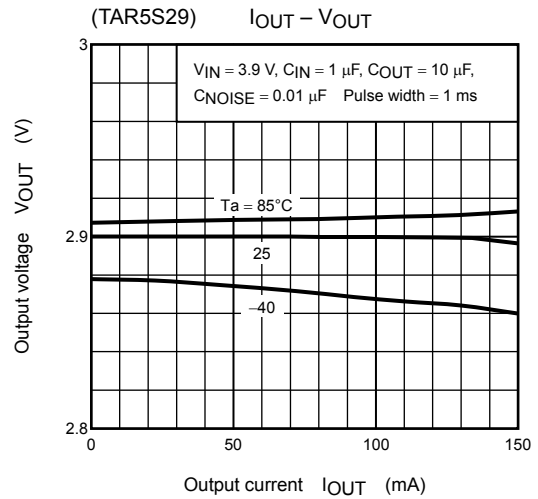
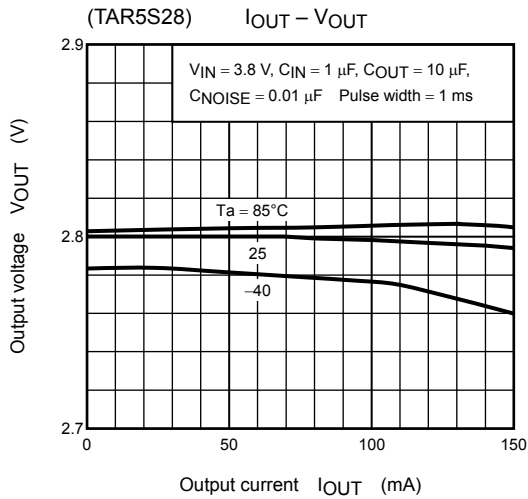
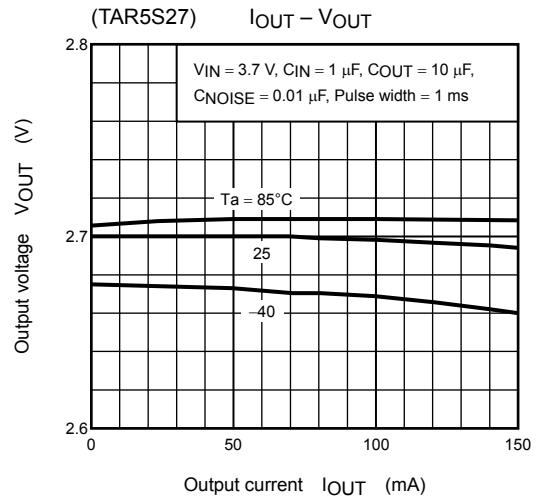
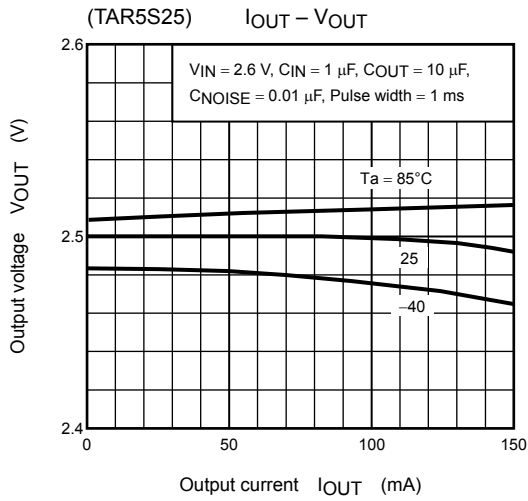

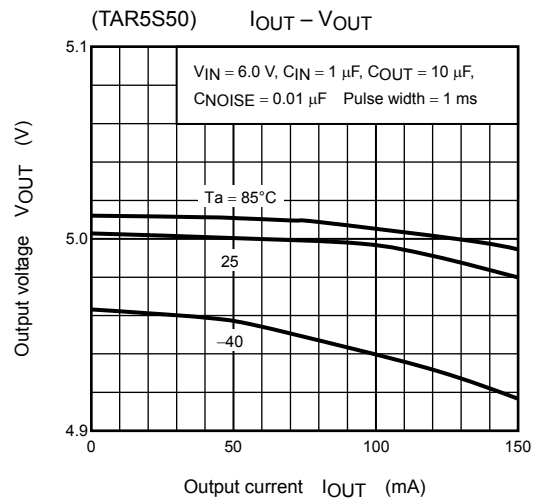
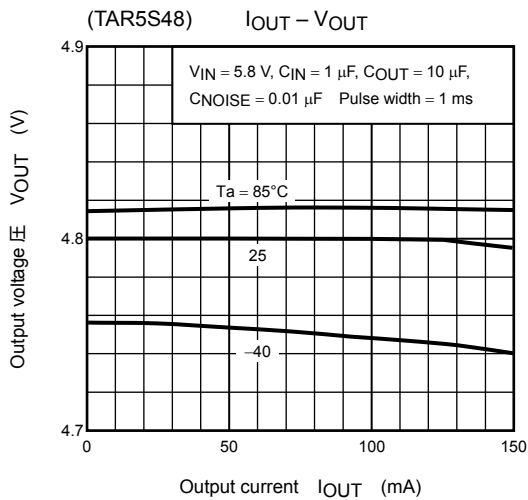
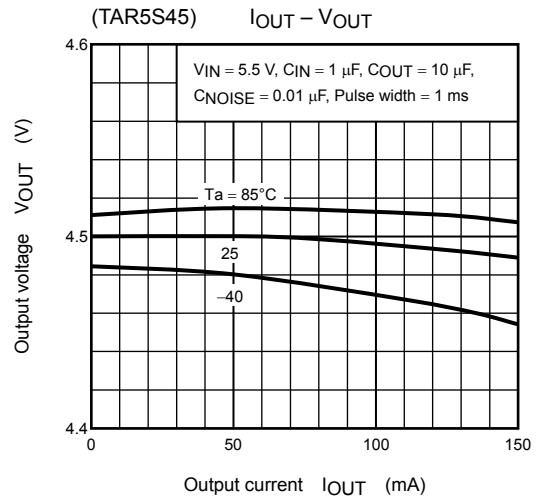
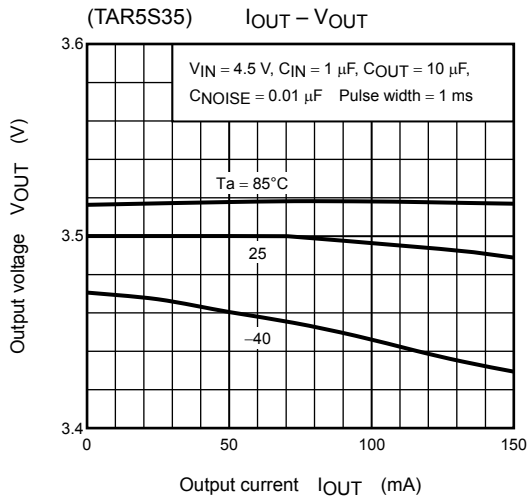
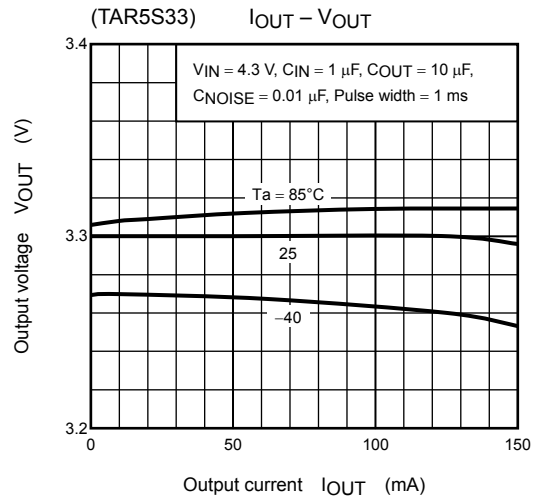
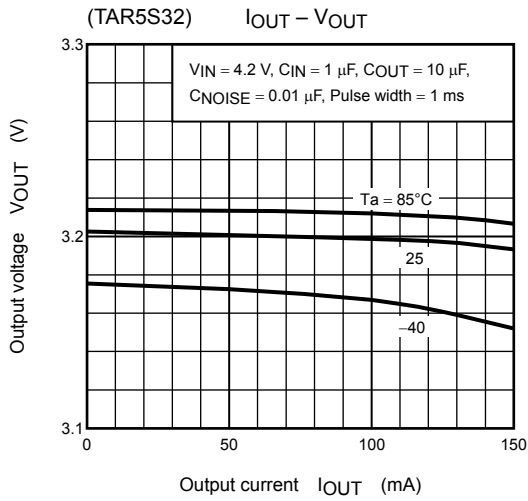

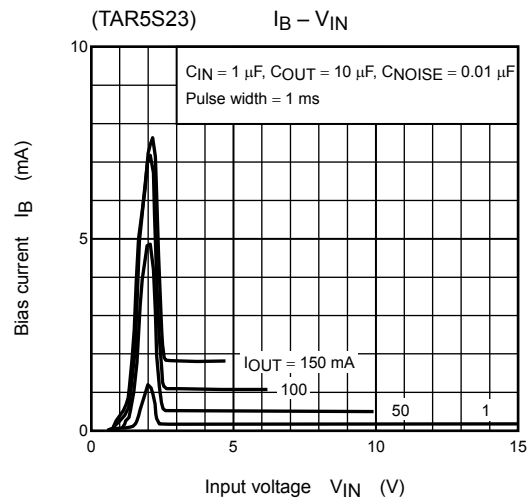
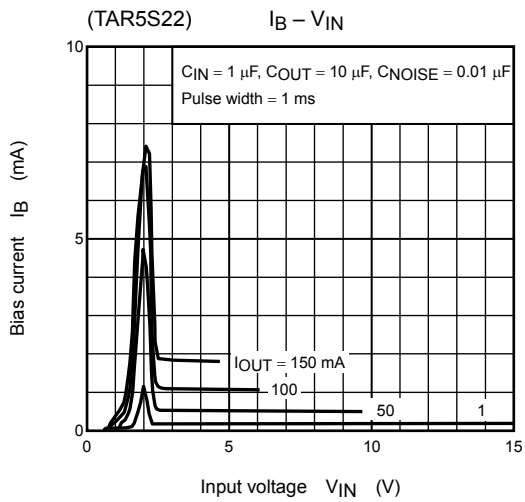
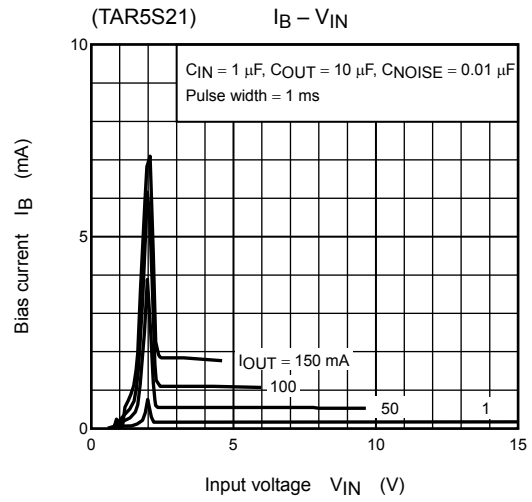
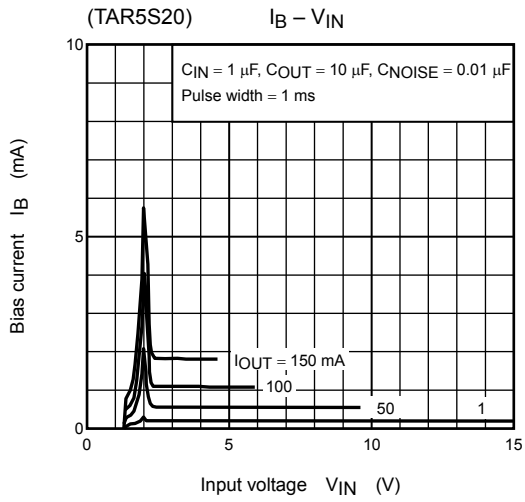
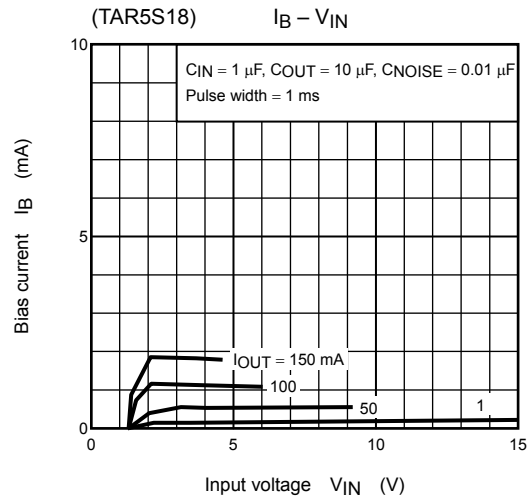
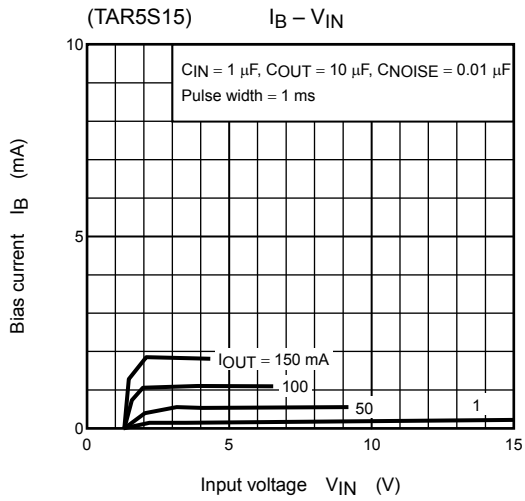

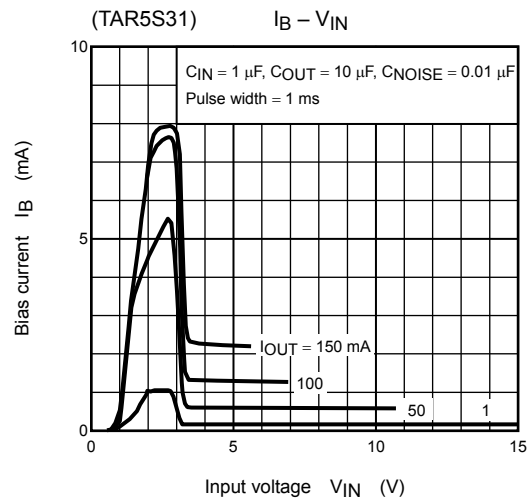
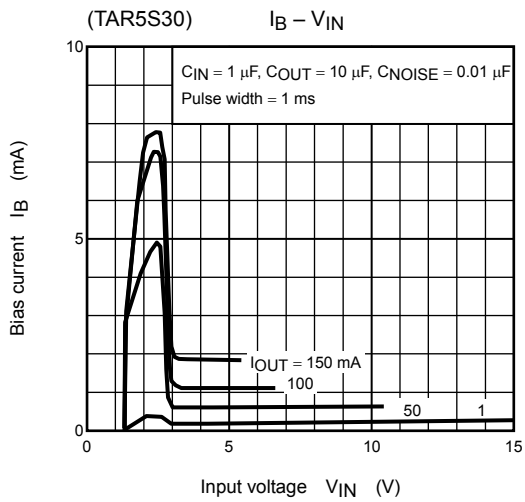
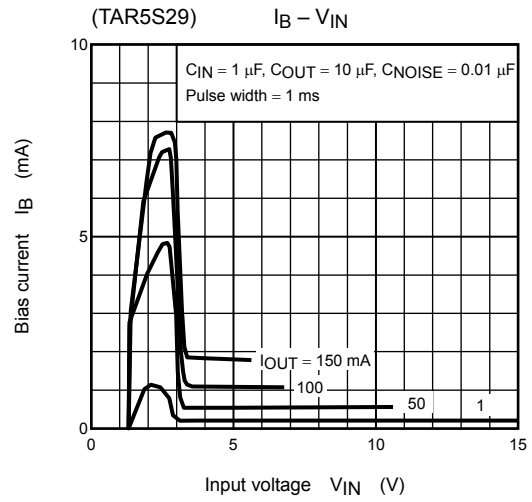
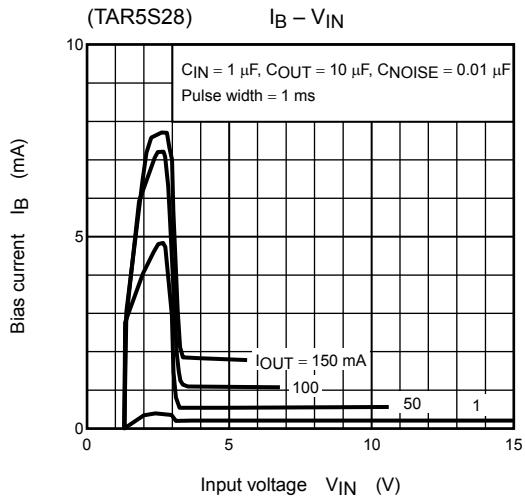
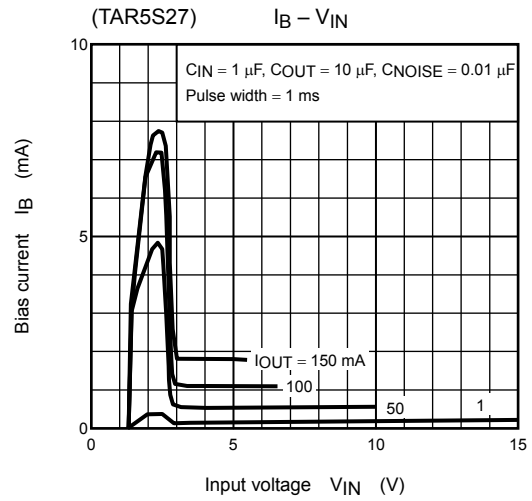
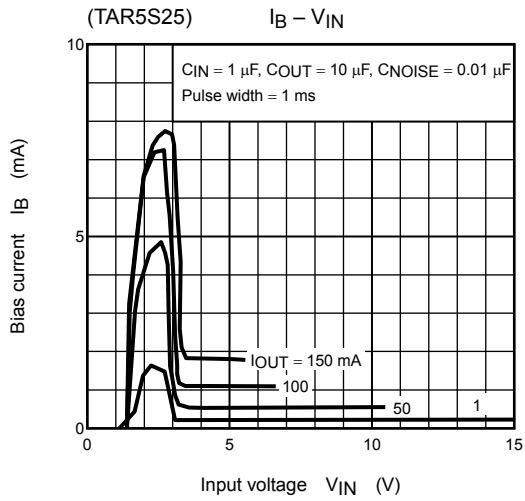

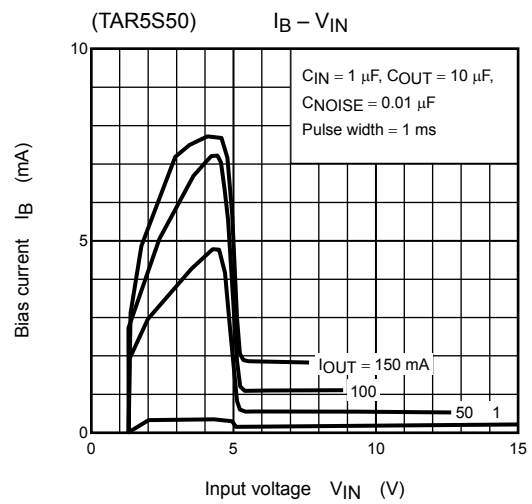
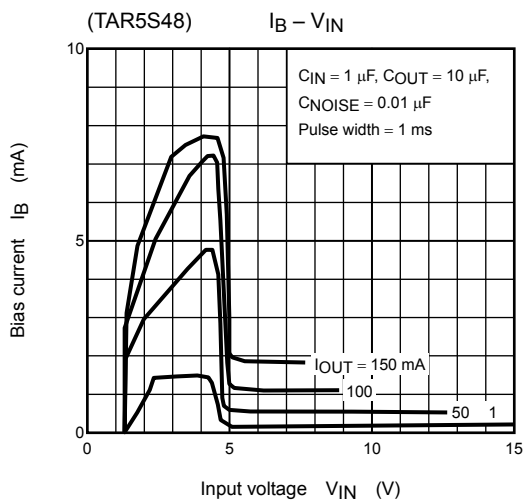
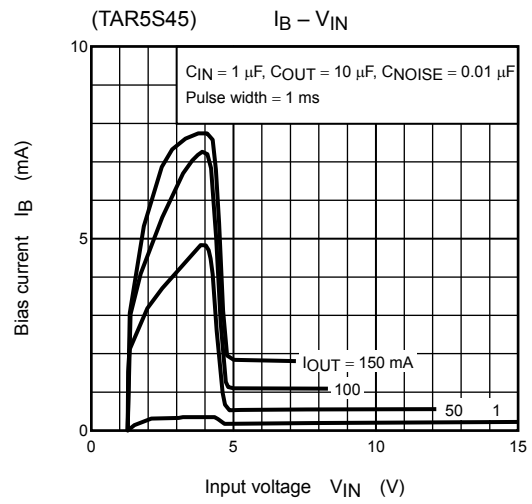
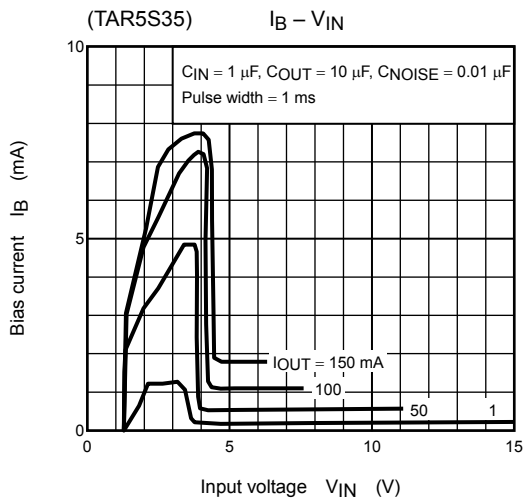
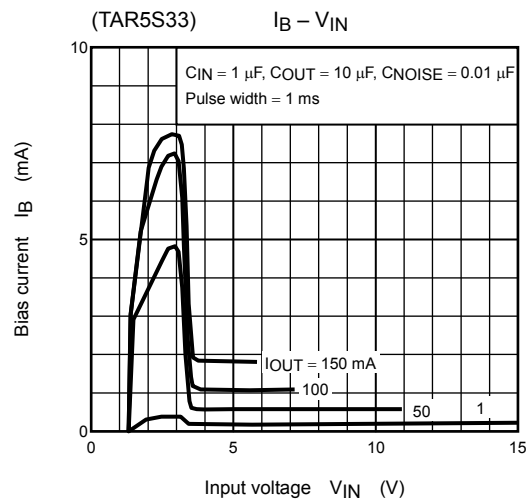
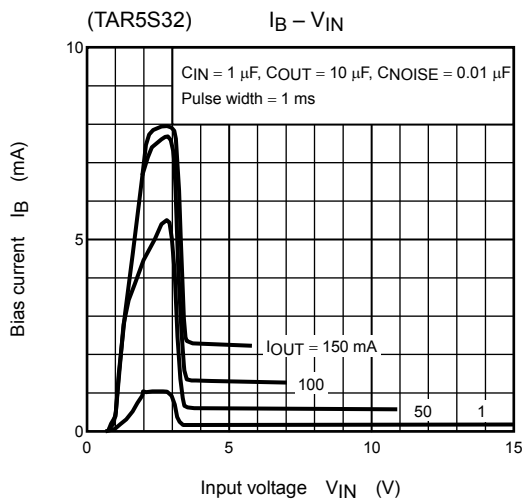

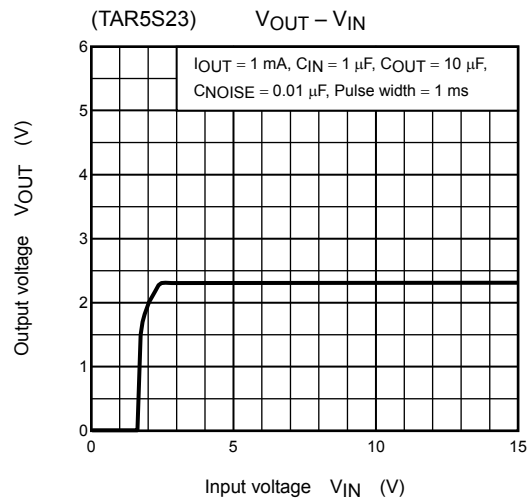
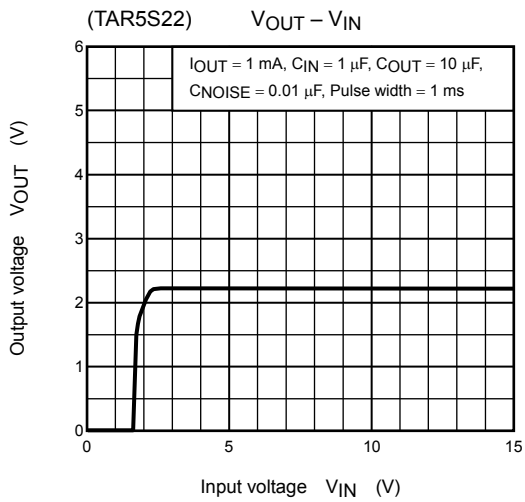
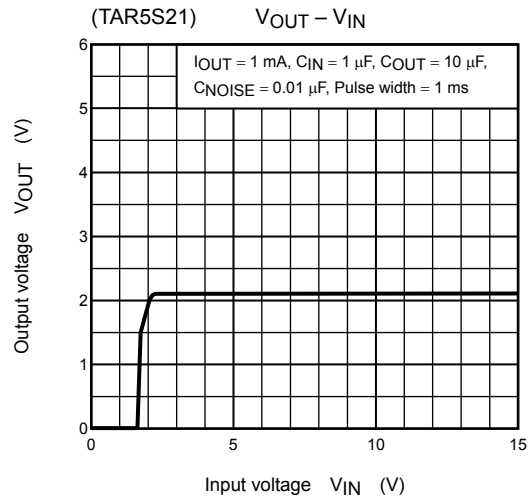
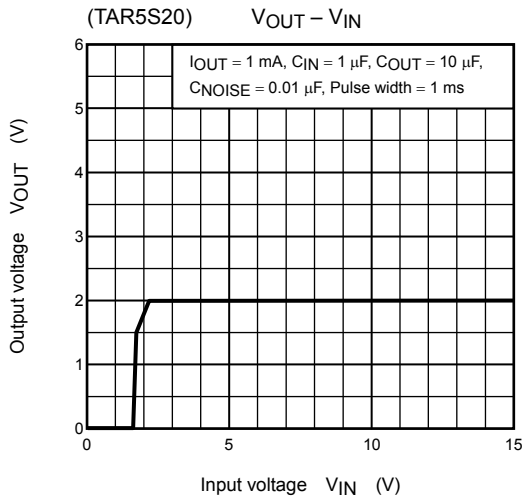
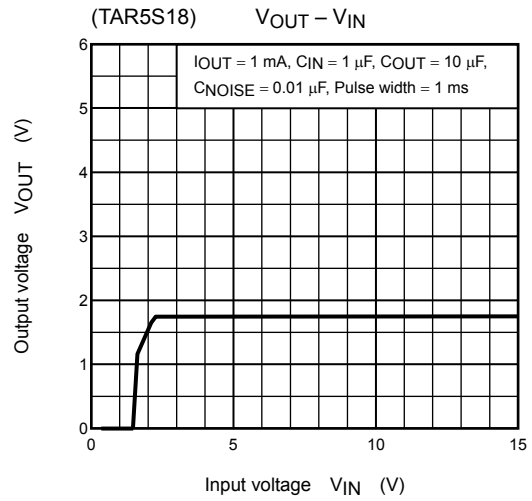
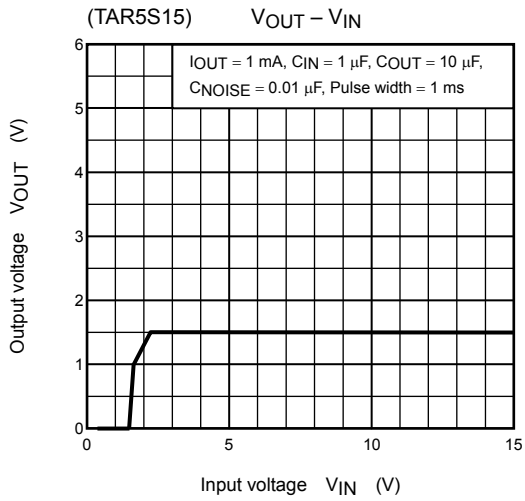

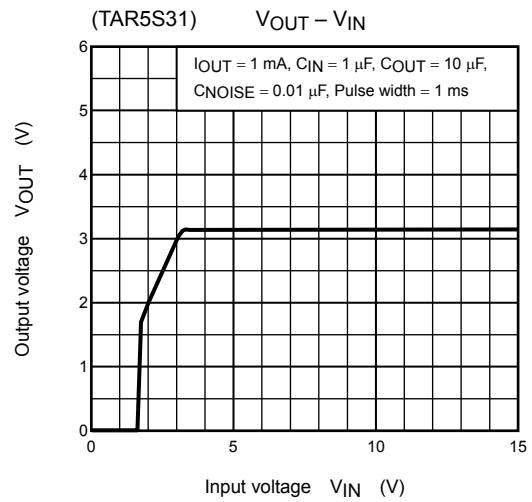
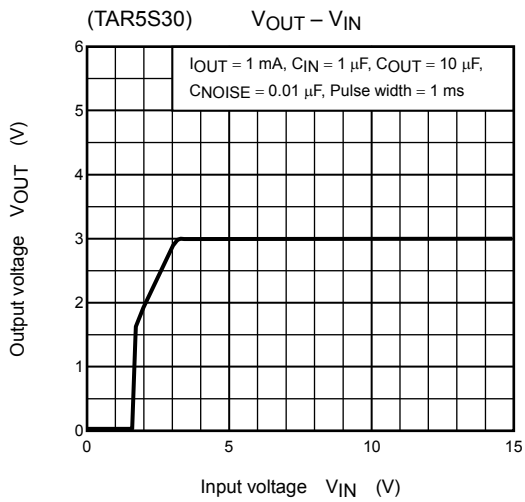
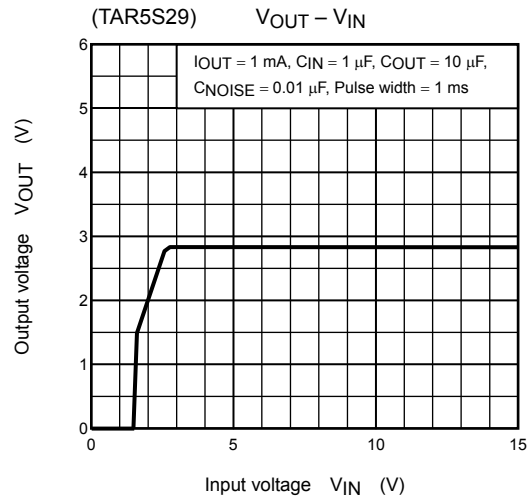
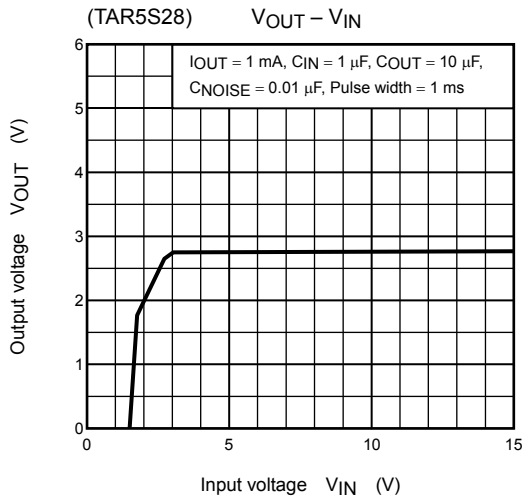
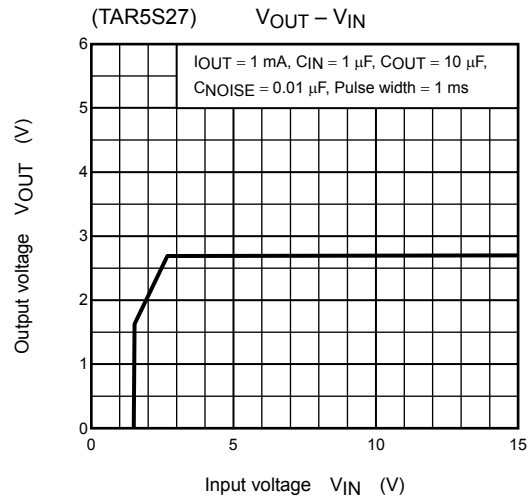
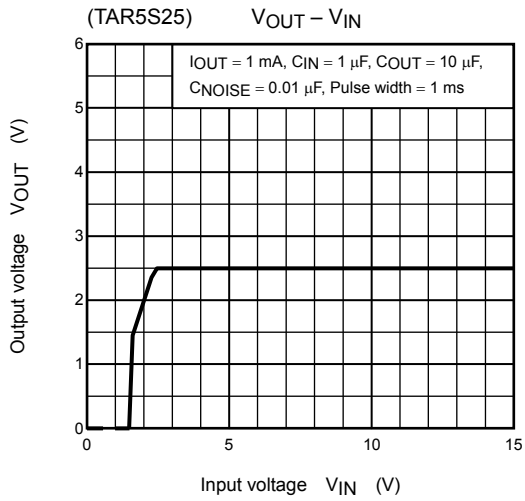

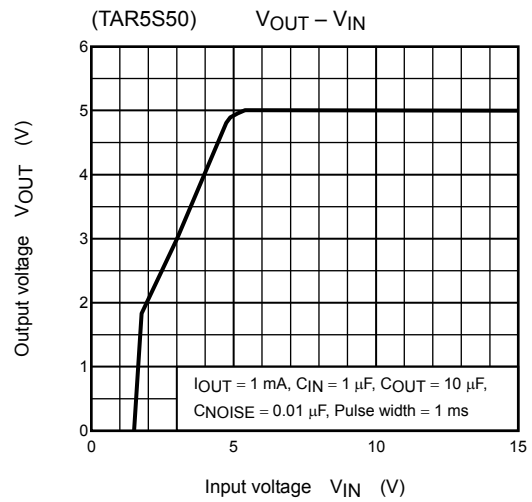
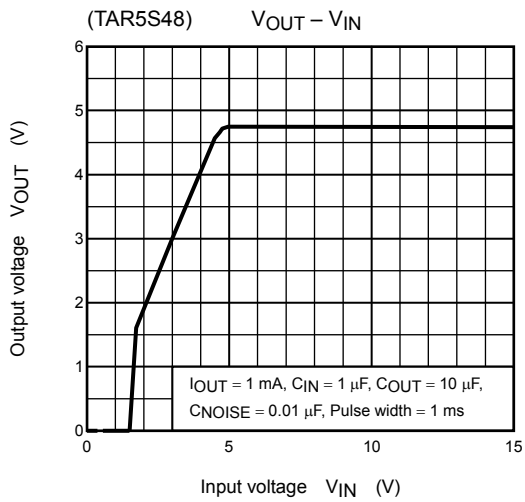
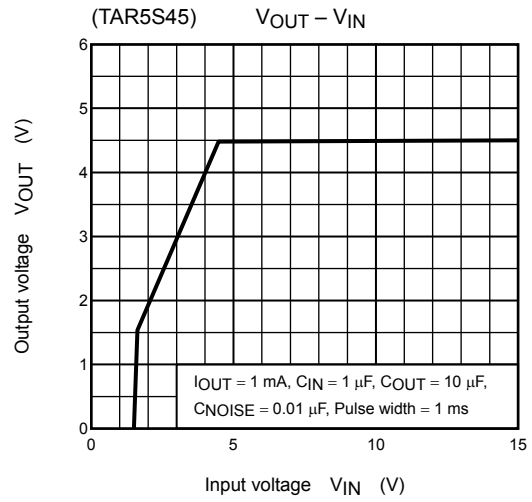
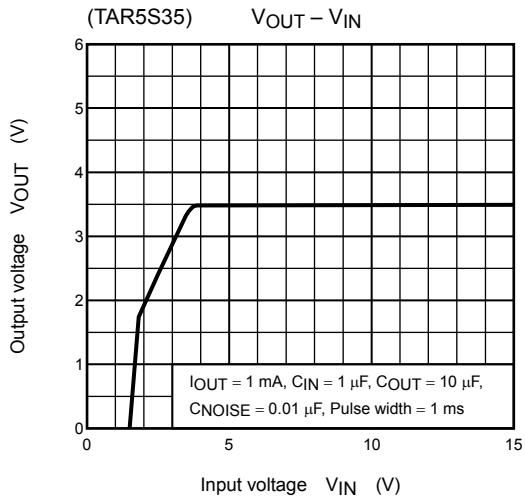
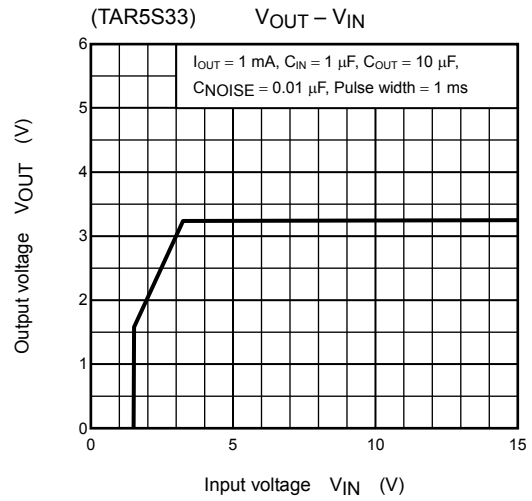
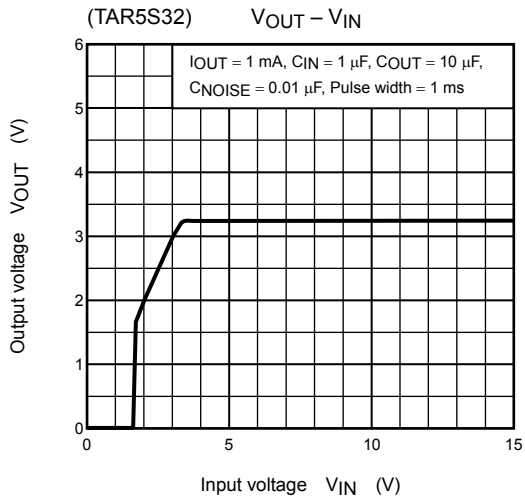

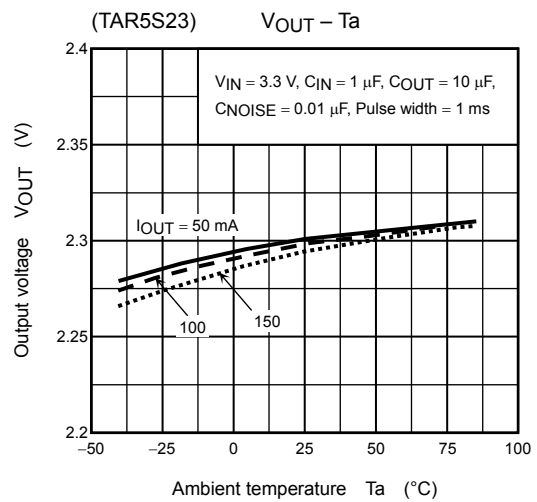
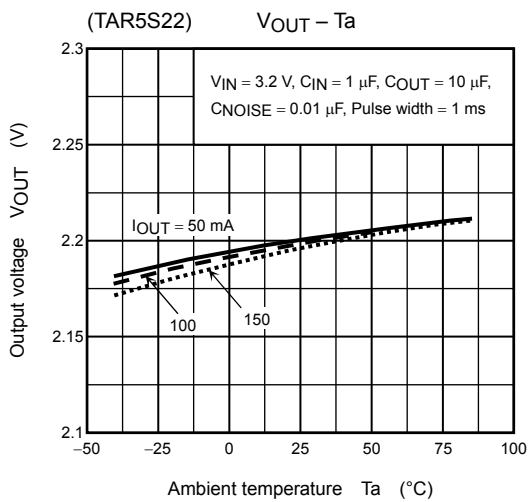
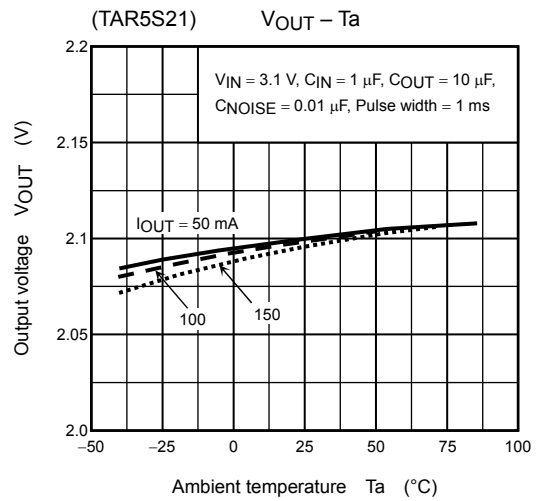
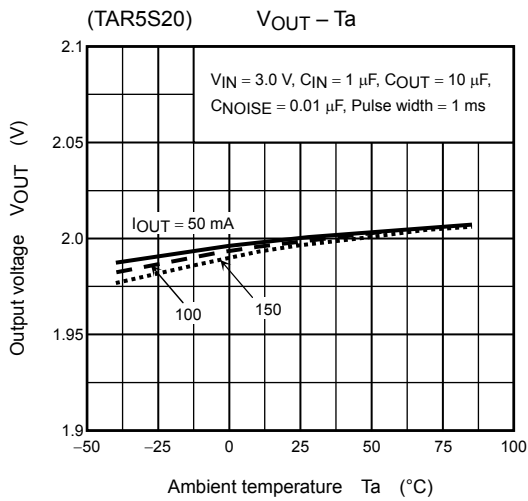
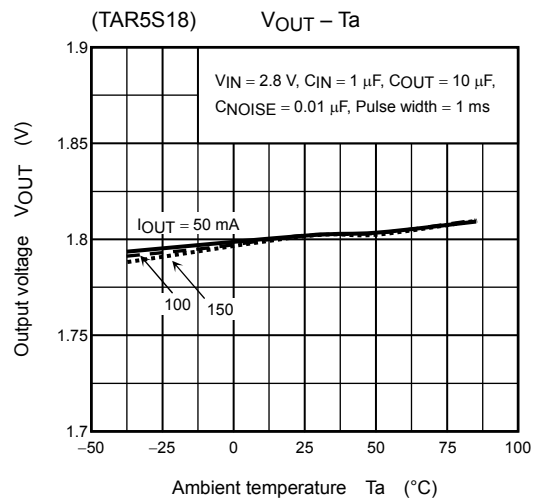
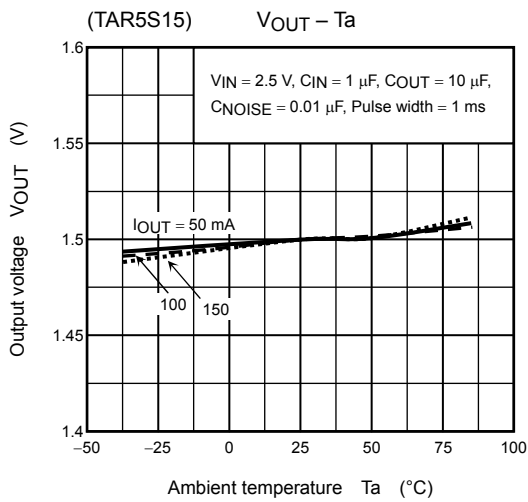

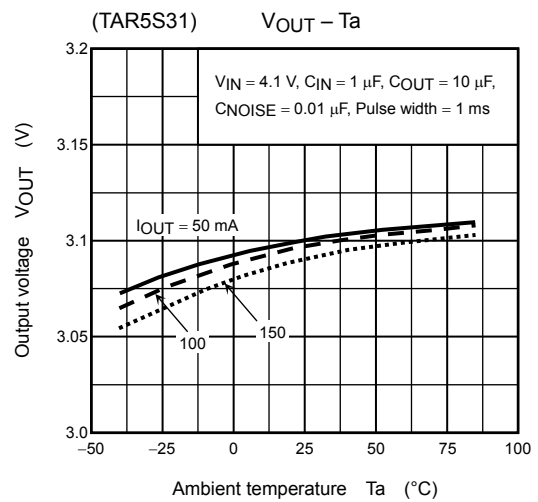
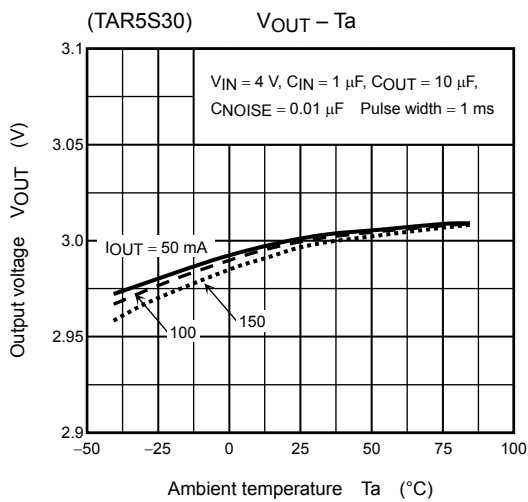
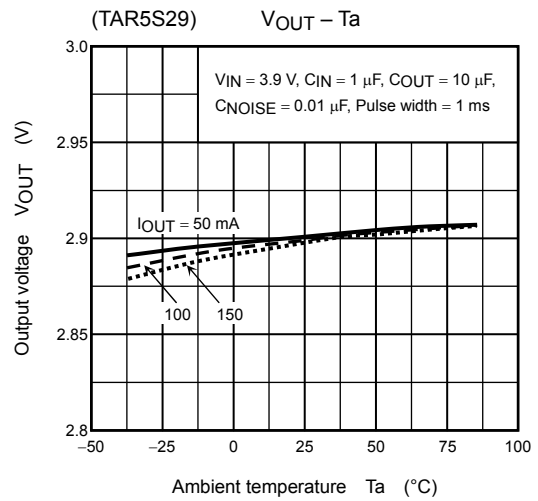
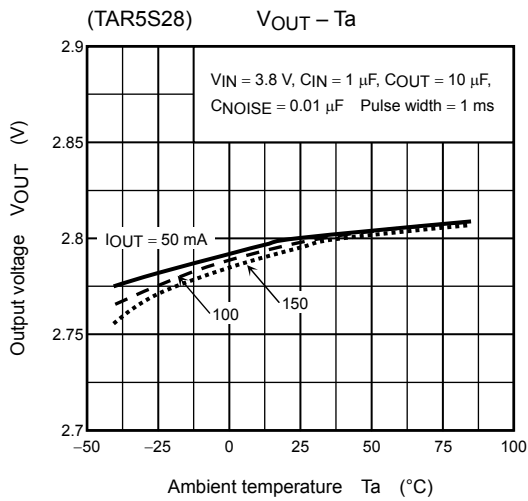
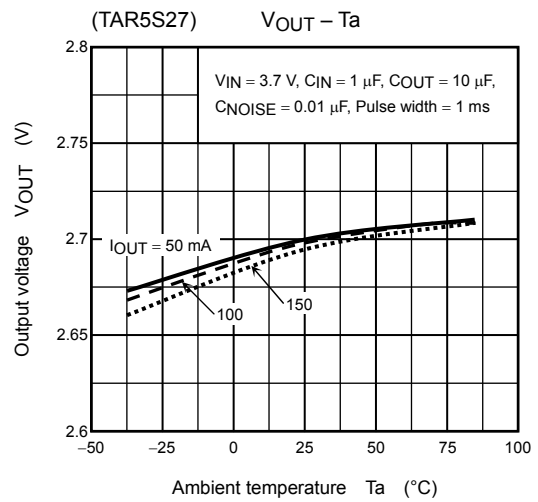
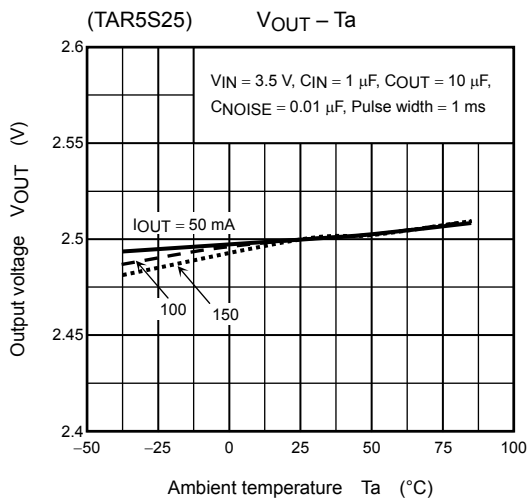

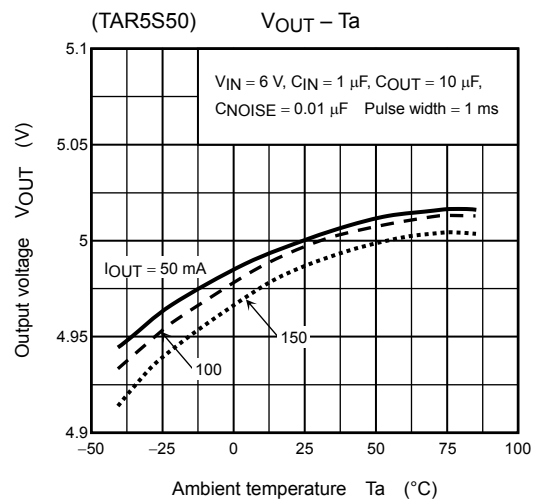
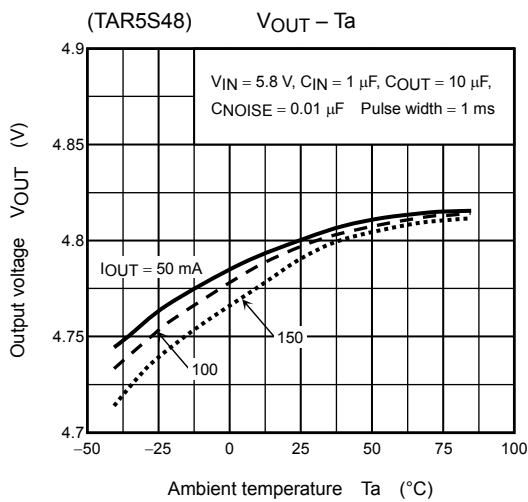
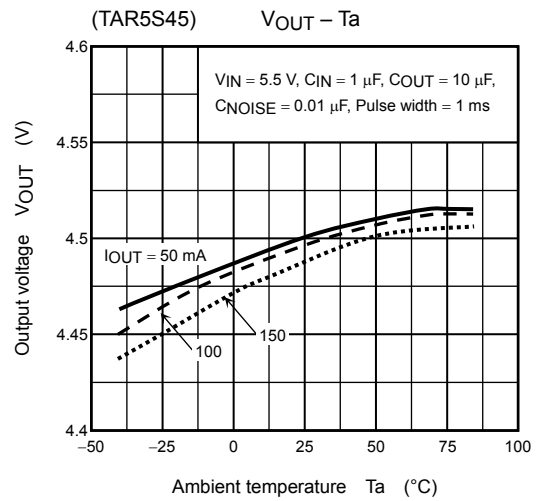
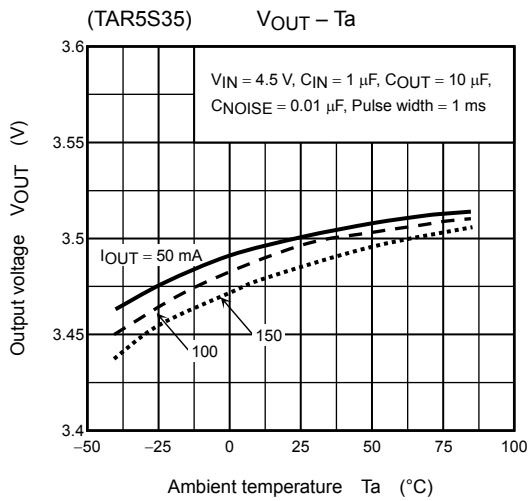
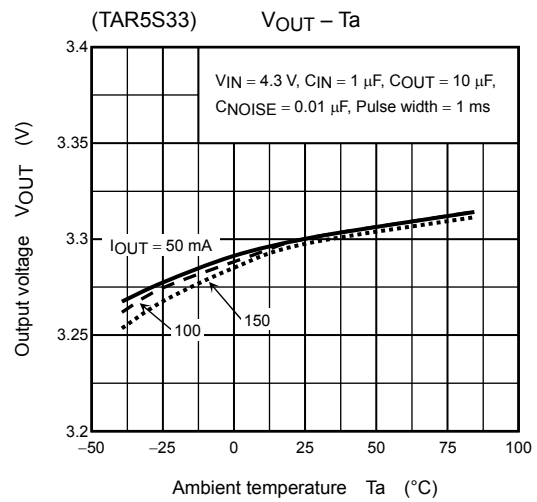
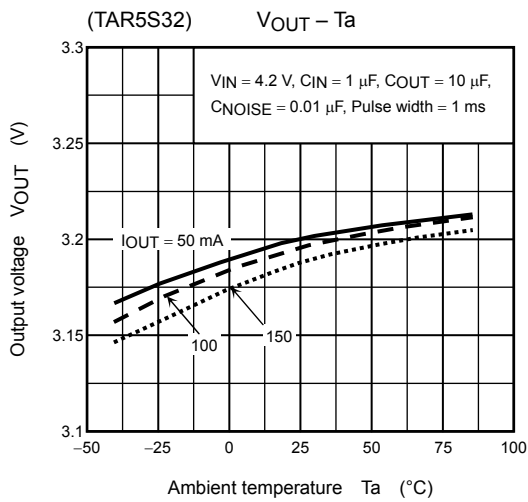

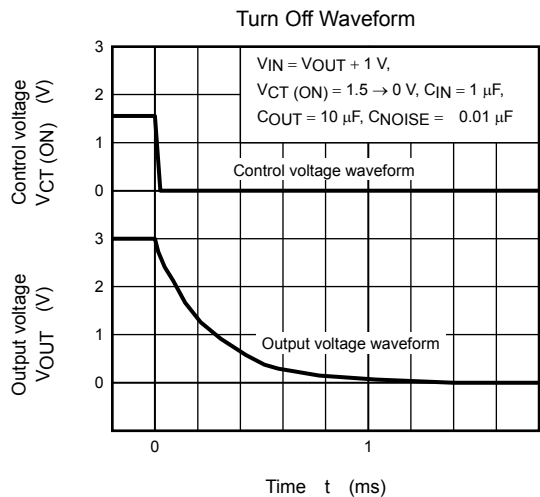
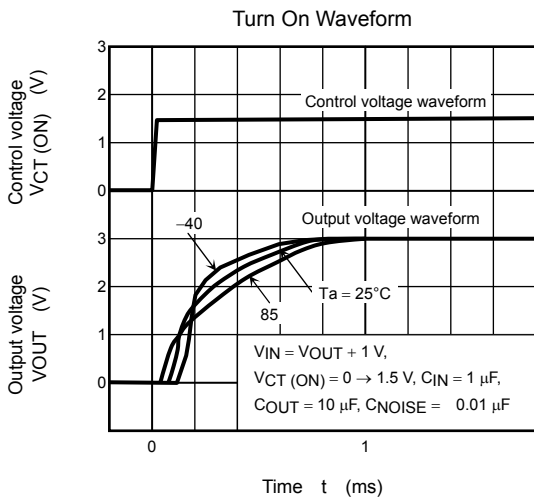
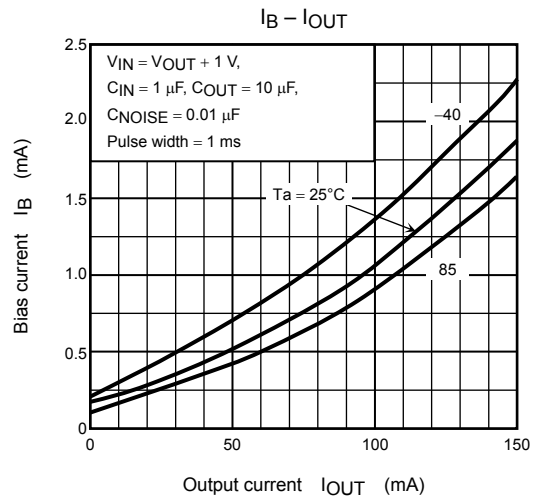
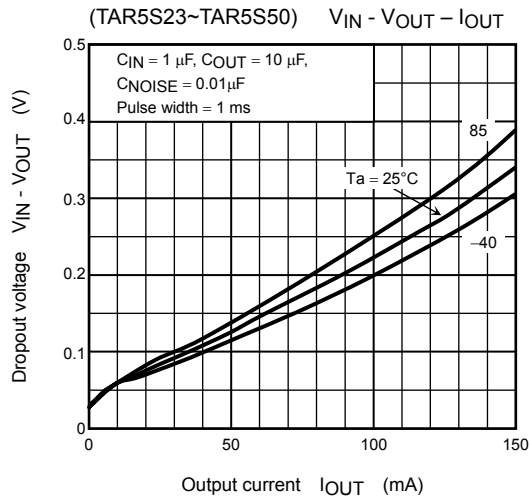
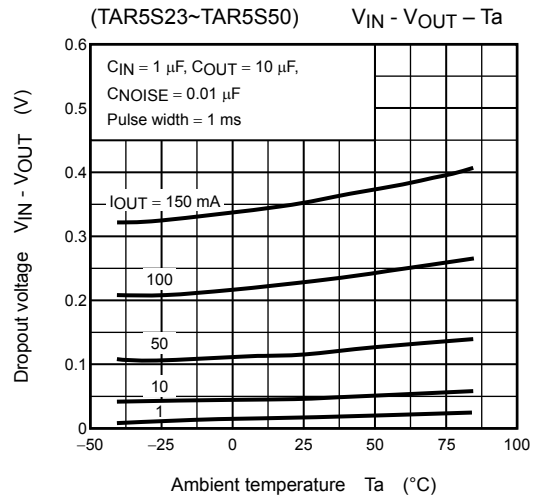
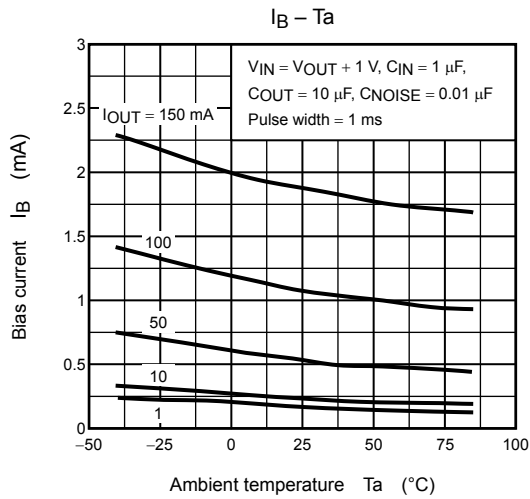

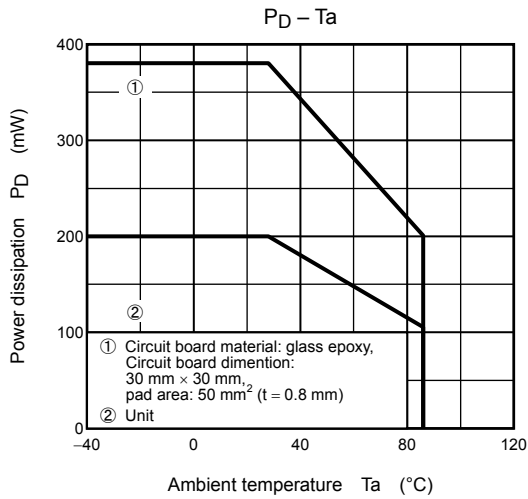
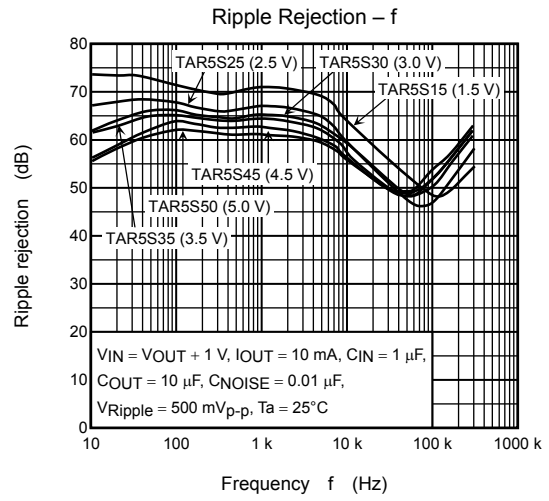
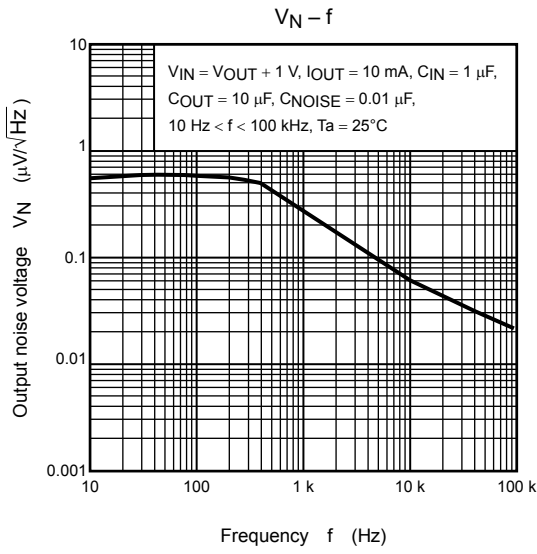

Package Dimensions

SSOP5-P-0.95

Unit : mm

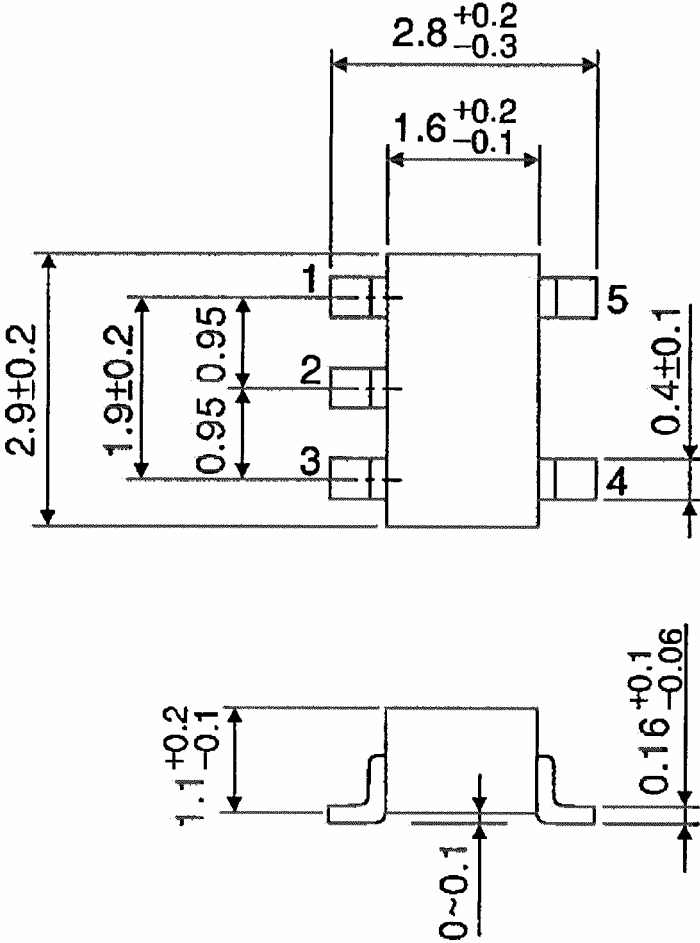

Weight: 0.014 g (typ.)

RESTRICTIONS ON PRODUCT USE

20070701-EN GENERAL

- The information contained herein is subject to change without notice.
- TOSHIBA is continually working to improve the quality and reliability of its products. Nevertheless, semiconductor devices in general can malfunction or fail due to their inherent electrical sensitivity and vulnerability to physical stress. It is the responsibility of the buyer, when utilizing TOSHIBA products, to comply with the standards of safety in making a safe design for the entire system, and to avoid situations in which a malfunction or failure of such TOSHIBA products could cause loss of human life, bodily injury or damage to property.
In developing your designs, please ensure that TOSHIBA products are used within specified operating ranges as set forth in the most recent TOSHIBA products specifications. Also, please keep in mind the precautions and conditions set forth in the "Handling Guide for Semiconductor Devices," or "TOSHIBA Semiconductor Reliability Handbook" etc.
- The TOSHIBA products listed in this document are intended for usage in general electronics applications (computer, personal equipment, office equipment, measuring equipment, industrial robotics, domestic appliances, etc.). These TOSHIBA products are neither intended nor warranted for usage in equipment that requires extraordinarily high quality and/or reliability or a malfunction or failure of which may cause loss of human life or bodily injury ("Unintended Usage"). Unintended Usage include atomic energy control instruments, airplane or spaceship instruments, transportation instruments, traffic signal instruments, combustion control instruments, medical instruments, all types of safety devices, etc.. Unintended Usage of TOSHIBA products listed in this document shall be made at the customer's own risk.
- The products described in this document shall not be used or embedded to any downstream products of which manufacture, use and/or sale are prohibited under any applicable laws and regulations.
- The information contained herein is presented only as a guide for the applications of our products. No responsibility is assumed by TOSHIBA for any infringements of patents or other rights of the third parties which may result from its use. No license is granted by implication or otherwise under any patents or other rights of TOSHIBA or the third parties.
- Please contact your sales representative for product-by-product details in this document regarding RoHS compatibility. Please use these products in this document in compliance with all applicable laws and regulations that regulate the inclusion or use of controlled substances. Toshiba assumes no liability for damage or losses occurring as a result of noncompliance with applicable laws and regulations.