

800mA Standalone Linear Li-Ion Battery Charger with Thermal Regulation in ThinSOT

General Description

The LP4060A is a complete constant-current/constant-voltage linear charger for single cell lithium-ion batteries. Its ThinSOT package and low external component count make the LP4060A ideally suited for portable applications. Furthermore, the LP4060A is specifically designed to work within USB power specifications. No external sense resistor is needed, and no blocking diode is required due to the internal MOSFET architecture. Thermal feedback regulates the charge current to limit the die temperature during high power operation or high ambient temperature. The charge voltage is fixed at 4.2V, and the charge current can be programmed externally with a single resistor. The LP4060A automatically terminates the charge cycle when the charge current drops to 1/10th the programmed value after the final float voltage is reached. Other features include charge current monitor, undervoltage lockout, automatic recharge and a status pin to indicate charge termination and the presence of an input voltage.

Order Information

LP4060A - □ □ □ □ □
 F: Pb-Free
 Package Type
 B5: SOT23-5

Applications

- ✧ Portable Media Players/MP3 players
- ✧ Cellular and Smart mobile phone
- ✧ PDA/DSC
- ✧ Bluetooth Applications

Features

- Programmable Charge Current Up to 800mA
- No MOSFET, Sense Resistor or Blocking Diode Required
- Complete Linear Charger in ThinSOT Package for Single Cell Lithium-ion Batteries
- Constant-Current/Constant-Voltage Operation with Thermal Regulation to Maximize
- Charge Rate Without Risk of Overheating
- Charges Single Cell Li-Ion Batteries Directly from USB Port
- Preset 4.2V Charge Voltage with $\pm 1\%$ Accuracy
- Available in SOT23-5 Package
- Charge Current Monitor Output for Gas Gauging
- Automatic Recharge
- 2.9V Trickle Charge Threshold
- C/10 Charge Termination

Typical Application Circuit

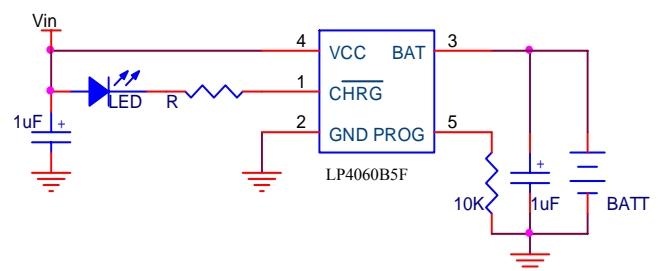

Marking Information

Please see website.

Functional Pin Description

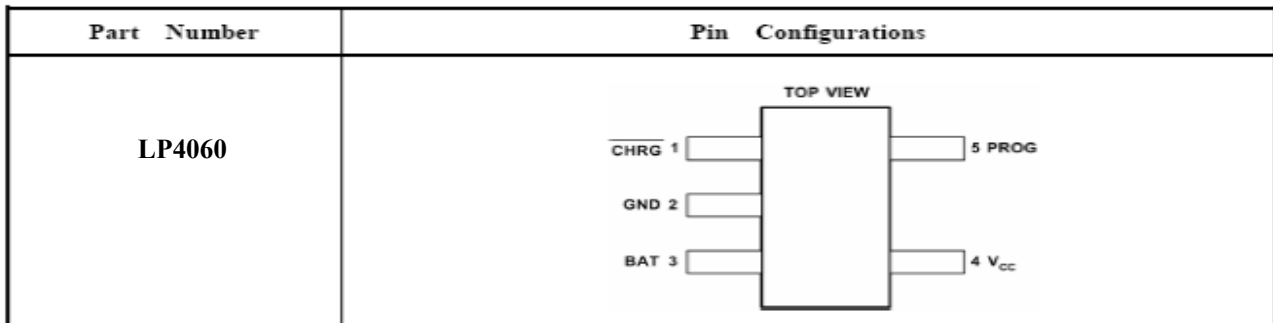

Pin Number	Pin Name	Pin Function
1	CHRG	Open-Drain Status Output
2	GND	Ground.
3	BAT	Charge Current Output
4	VCC	Positive Input Supply Voltage
5	PROG	Charge Current Program, Charge Current Monitor and Shutdown Pin.

CHRG (PIN 1):

Open-Drain Charge Status Output. When the battery is charging, the CHRG pin is pulled low by an internal N-channel MOSFET. When the charge cycle is completed, a weak pull-down of approximately 12µA is connected to the CHRG pin, indicating a “AC present” condition. When the LP4060A detects an undervoltage lockout condition, CHRG is forced high impedance.

GND (PIN 2): Ground.

BAT (PIN 3): Charge Current Output. Provides charge current to the battery and regulates the final float voltage to 4.2V. An internal precision resistor divider from this pin sets the float voltage which is disconnected in shutdown mode.

VCC (PIN 4): Positive Input Supply Voltage. Provides power to the charger. Vcc can range from 4.35V to 6.5V and should be bypassed with at least a 1µF capacitor. When Vcc drops to within 30mV of the BAT pin voltage, the LP4060A enters shutdown mode, dropping IBAT to less than 2µA.

PROG (PIN 5): Charge Current Program, Charge Current Monitor and Shutdown Pin. The charge current is programmed by connecting a 1% resistor, R_{PROG}, to ground. When charging in constant-current mode, this pin serves to 1V. In all modes, the voltage on this pin can be used to measure the charge current using the following formula:

$$I_{BAT} = (V_{PROG} / R_{PROG}) \times 830$$

The PROG pin can also be used to shutdown the charger. Disconnecting the program resistor from ground allows a 3µA current to pull the PROG pin high. When it reaches the 1.94V shutdown threshold voltage, the charger enters shutdown mode, charging stops and the input supply current drops to 25µA. This pin is also clamped to approximately 2.4V. Driving this pin to voltages beyond the clamp voltage will draw currents as high as 1.5mA. Reconnecting R_{PROG} to ground will return the charger to normal operation.

Function Block Diagram

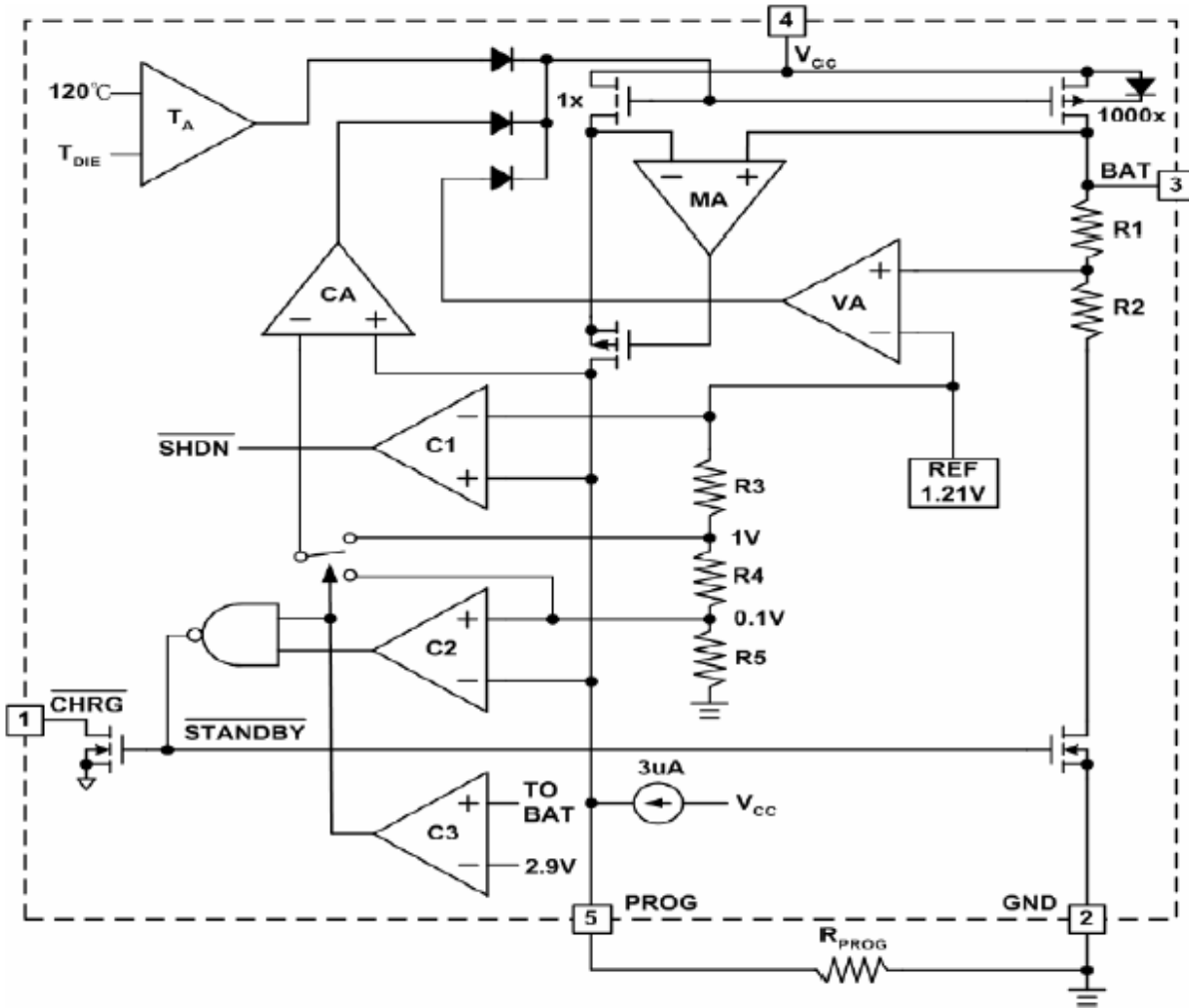

Absolute Maximum Ratings

Input Supply Voltage-----	-0.3V to 6.5V
PROG-----	-0.3V to Vcc+0.3V
BAT-----	-0.3V to 6.5V
CHRG-----	-0.3V to 6.5V
BAT Pin Current-----	800mA
BAT Short-circuit Duration-----	Continuous
PROG Pin Current-----	800uA
Operation Temperature Range-----	-40°C to 85°C
Junction Temperature -----	125°C
Storage Temperature -----	-65°C to 125°C
Lead Temp(Soldering,10sec) -----	300°C

Electrical Characteristics

 ((Over $0^{\circ}\text{C} \leq T_J \leq 125^{\circ}\text{C}$ and recommended supply voltage))

Symbol	Parameter	Conditions	LP4060			Unit
			Min.	Typ.	Max.	
V_{CC}	Input Supply Voltage		4.35		6.5	V
I_{CC}	Input Supply Current	Charge Mode (Note 4), $R_{PROG} = 10k$ Standby Mode (Charge Terminated) Shutdown Mode (R_{PROG} Not Connected, $V_{CC} < V_{BAT}$, or $V_{CC} < V_{UV}$)		350 200 25	2000 500 50	μA
V_{FLOAT}	Regulated Output (Float) Voltage	$0^{\circ}\text{C} \leq T_A \leq 85^{\circ}\text{C}$, $I_{BAT} = 40\text{mA}$	4.158	4.2	4.242	V
I_{BAT}	BAT Pin Current	$R_{PROG} = 10k$, Current Mode $R_{PROG} = 2k$, Current Mode Standby Mode, $V_{BAT} = 4.2\text{V}$ Shutdown Mode (R_{PROG} Not Connected) Sleep Mode, $V_{CC} = 0\text{V}$	100 475 0	110 510 -2.5 ± 1 ± 1	120 545 -6 ± 2 ± 2	mA mA μA μA μA
I_{TRIKL}	Trickle Charge Current	$V_{BAT} < V_{TRIKL}$, $R_{PROG} = 2k$ (Note 5)	20	50	70	mA
V_{TRIKL}	Trickle Charge Threshold Voltage	$R_{PROG} = 10k$, V_{BAT} Rising (Note 5)	2.8	2.9	3.0	V
V_{TRHYS}	Trickle Charge Hysteresis Voltage	$R_{PROG} = 10k$ (Note 5)	60	80	110	mV
V_{UV}	V_{CC} Undervoltage Lockout Threshold	From V_{CC} Low to High	3.55	3.7	3.85	V
V_{UVHYS}	V_{CC} Undervoltage Lockout Hysteresis		150	200	300	mV
V_{MSD}	Manual Shutdown Threshold Voltage	PROG Pin Rising	1.85	1.94	2.05	V
V_{ASD}	$V_{CC} - V_{BAT}$ Lockout Threshold Voltage	V_{CC} from Low to High V_{CC} from High to Low	70 5	100 30	140 50	mV
I_{TERM}	C/10 Termination Current Threshold	$R_{PROG} = 10k$ (Note 6) $R_{PROG} = 2k$	0.085 0.085	0.10 0.10	0.115 0.115	mA/mA
V_{PROG}	PROG Pin Voltage	$R_{PROG} = 10k$, Current Mode	0.96	1.03	1.10	V
I_{CHRG}	$\overline{\text{CHRG}}$ Pin Weak Pull-Down Current	$V_{\overline{\text{CHRG}}} = 5\text{V}$	7	12	20	μA
$V_{\overline{\text{CHRG}}}$	$\overline{\text{CHRG}}$ Pin Output Low Voltage	$I_{\overline{\text{CHRG}}} = 5\text{mA}$		0.35	0.6	V
ΔV_{RECHRG}	Recharge Battery Threshold Voltage	$V_{FLOAT} - V_{RECHRG}$	100	150	200	mV
T_{LTM}	Junction Temperature in Constant Temperature Mode			120		$^{\circ}\text{C}$
R_{ON}	Power FET "ON" Resistance (Between V_{CC} and BAT)			600		$\text{m}\Omega$
t_{SS}	Soft-Start Time	$I_{BAT} = 0$ to $I_{BAT} = 1000\text{V}/R_{PROG}$		100		μs
$t_{RECHARGE}$	Recharge Comparator Filter Time	V_{BAT} High to Low	0.75	2	4.5	ms
t_{TERM}	Termination Comparator Filter Time	I_{BAT} Falling Below $I_{CHG}/10$	400	1000	2500	μs
I_{PROG}	PROG Pin Pull-Up Current			3		μA

Note 1: Absolute Maximum Ratings are those values beyond which the life of the device may be impaired.

 Note 2: The LP4060A are guaranteed to meet performance specifications from 0°C to 70°C .

Specifications over the -40°C to 85°C operating temperature range are assured by design, characterization and correlation with statistical process controls.

Note 3: See Thermal Considerations.

 Note 4: Supply current includes PROG pin current (approximately $100\mu\text{A}$) but does not include any current delivered to the battery through the BAT pin (approximately 100mA).

Note 5: This parameter is not applicable to the LP4060AX.

 Note 6: I_{TERM} is expressed as a fraction of measured full charge current with indicated PROG resistor.

Typical Operating Characteristics

PROG Pin Voltage vs Supply Voltage (Constant Current Mode)

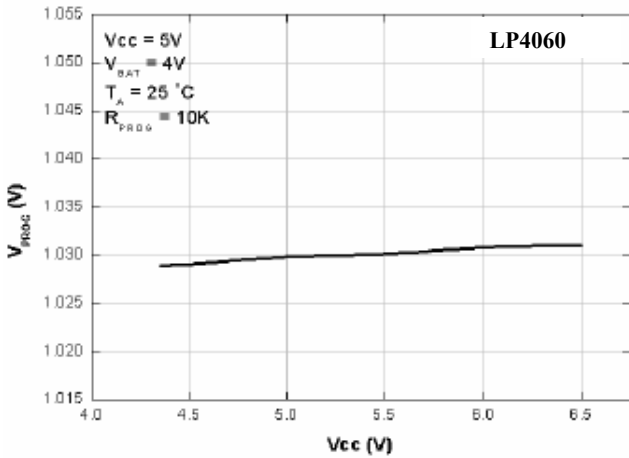

PROG Pin Voltage vs Temperature

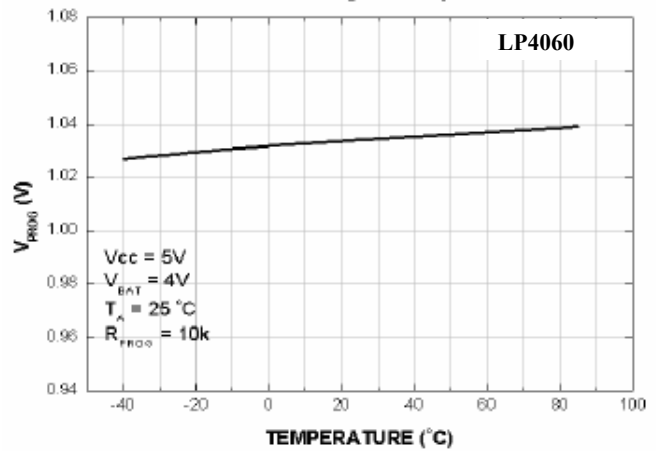

Charge Current vs PROG Pin Voltage

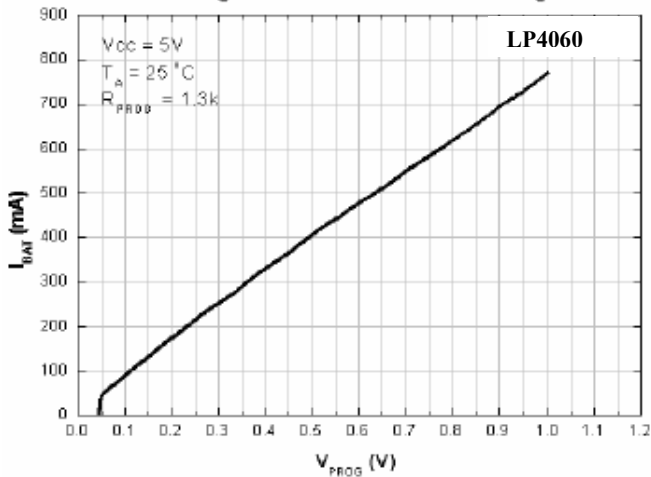

PROG Pin Pull-Up Current vs Temperature and Supply Voltage

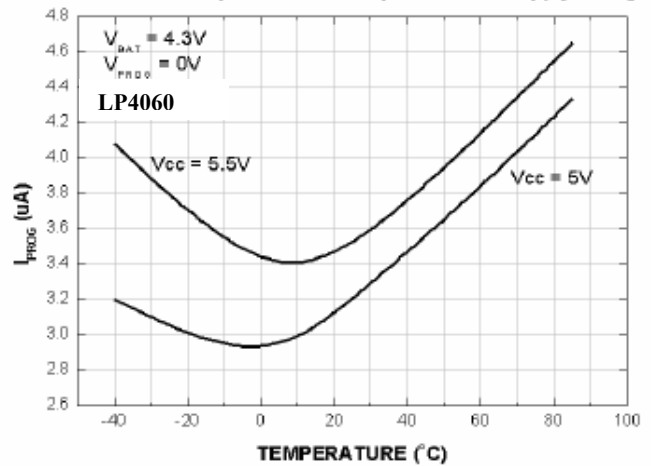

PROG Pin Current vs PROG Pin Voltage (Pull-Up Current)

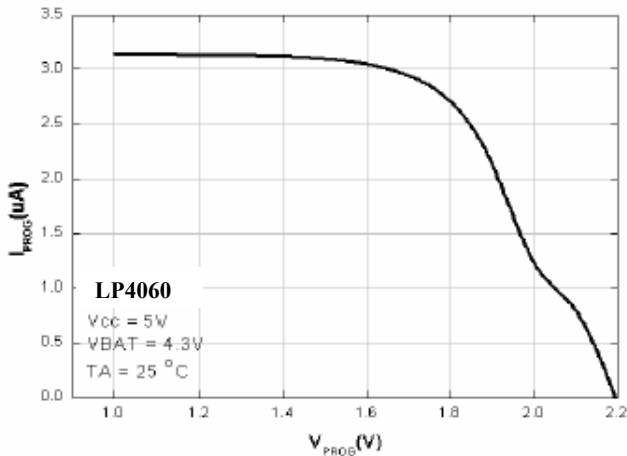

PROG Pin Current vs PROG Pin Voltage (Clamp Current)

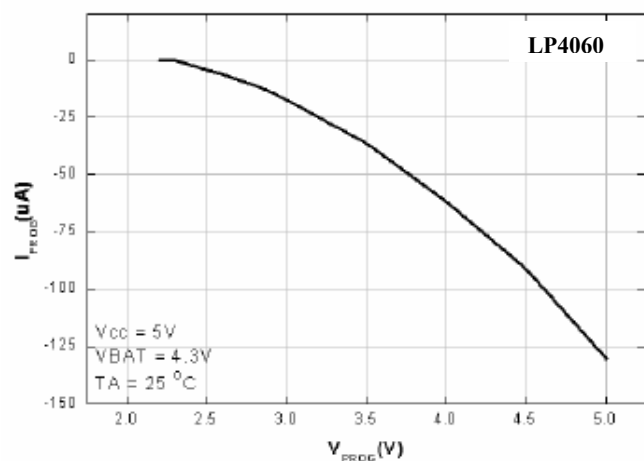

Regulated Output (Float) Voltage vs Charge Current

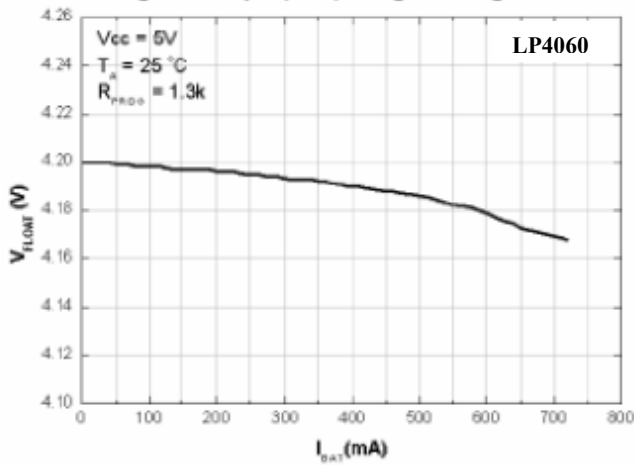

Regulated Output (Float) Voltage vs Temperature

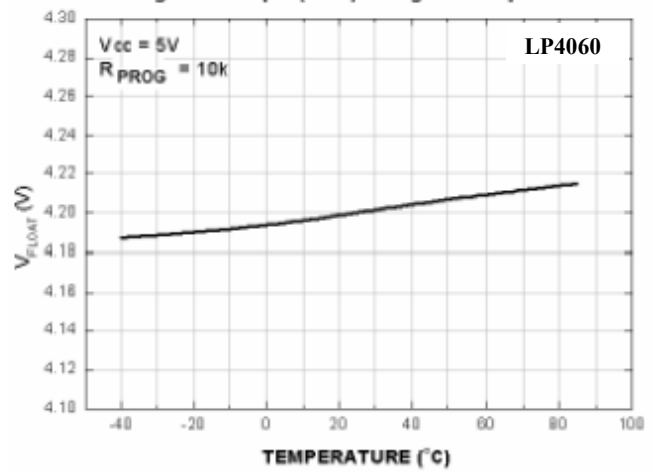

Regulated Output (Float) Voltage vs Supply Voltage

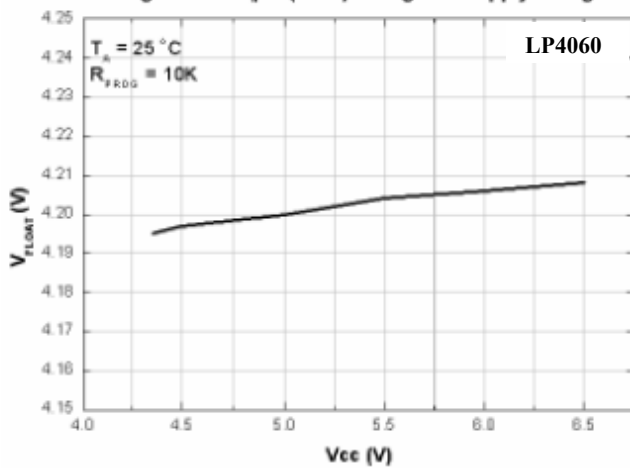

CHRG Pin I-V Curve (Strong Pull-Down State)

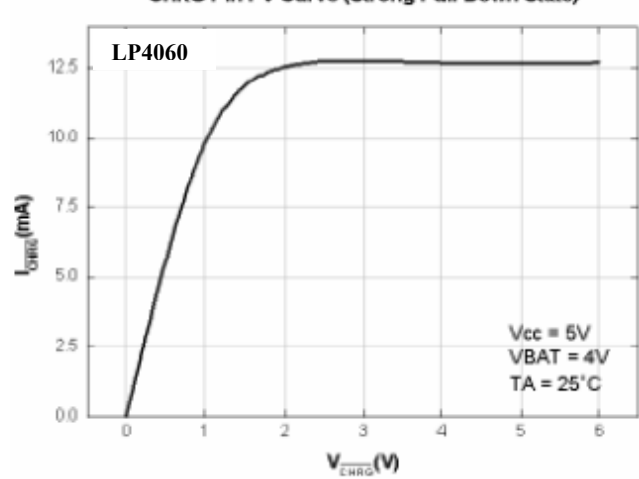

CHRG Pin I-V Curve (Weak Pull-Down State)

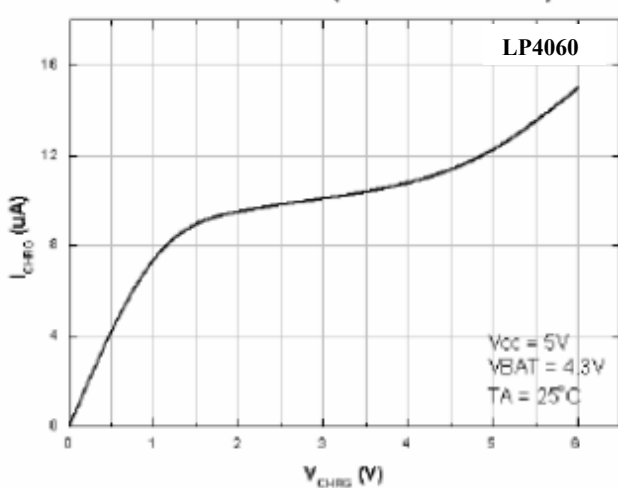

Trickle Charge Threshold vs Temperature

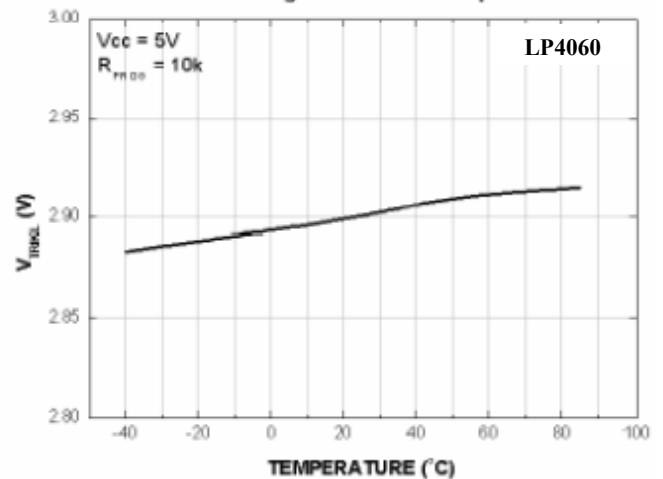

Trickle Charge Threshold vs Temperature

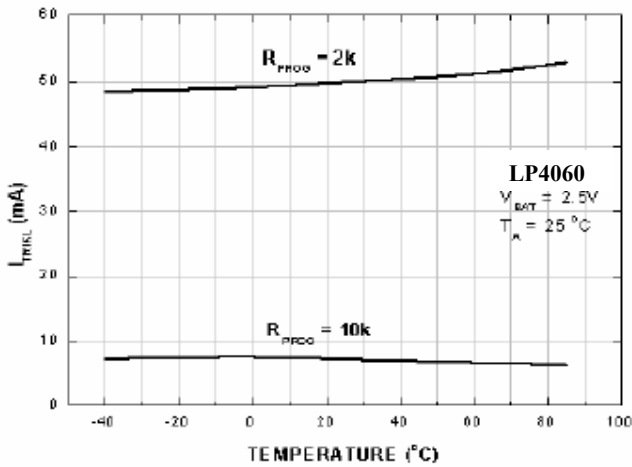

Trickle Charge Current vs Supply Voltage

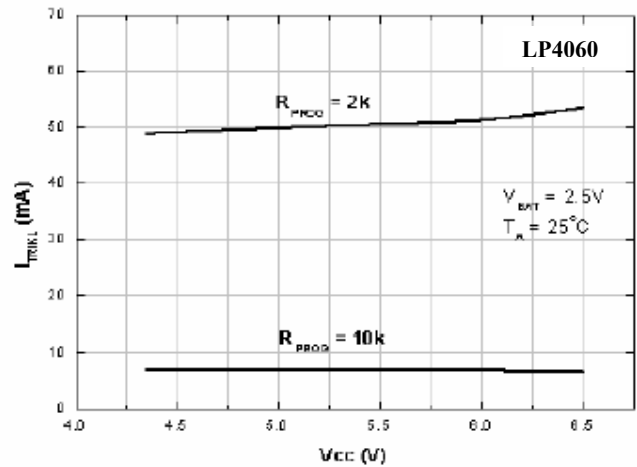

Charge Current vs Supply Voltage

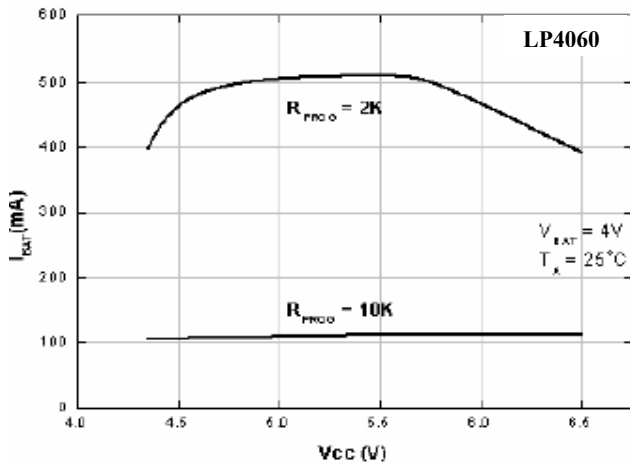

Charge Current vs Ambient Temperature

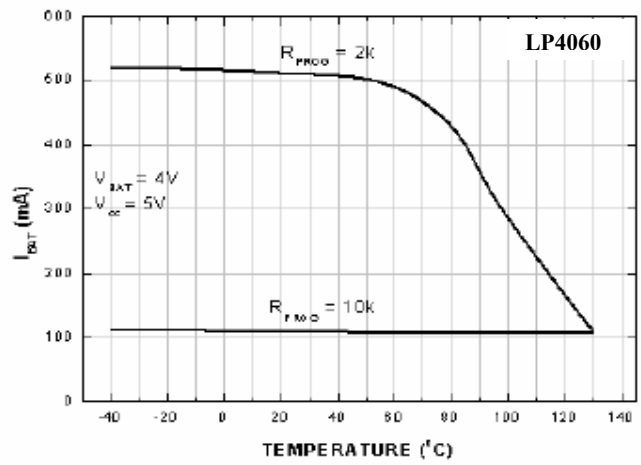

Recharge Voltage Threshold vs Temperature

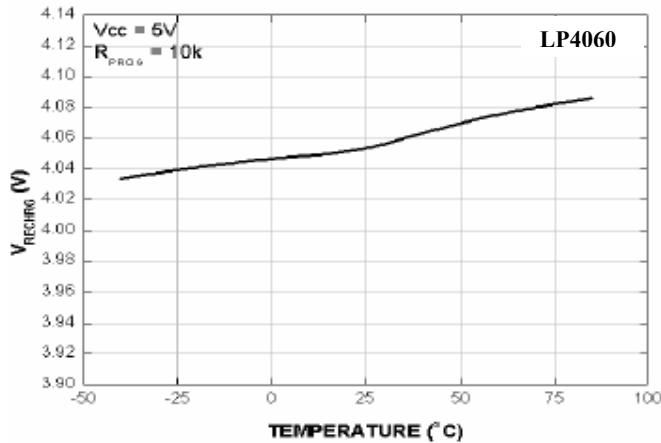

Trickle Charge Threshold vs Temperature

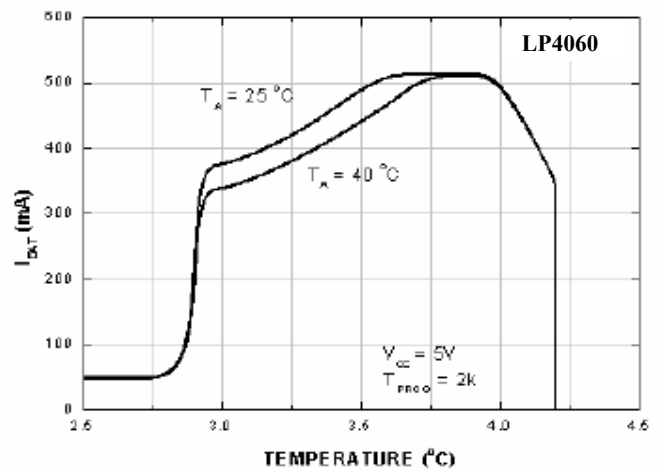

Applications Information

Operation

The LP4060A is a single cell lithium-ion battery charger using a constant-current/constant-voltage algorithm. It can deliver up to 800mA of charge current (using a good thermal PCB layout) with a final float voltage accuracy of $\pm 1\%$. The LP4060A includes an internal P-channel power MOSFET and thermal regulation circuitry. No blocking diode or external current sense resistor is required; thus, the basic charger circuit requires only two external components. Furthermore, the LP4060A is capable of operating from a USB power source.

Normal Charge Cycle

A charge cycle begins when the voltage at the VCC pin rises above the UVLO threshold level and a 1% program resistor is connected from the PROG pin to ground or when a battery is connected to the charger output. If the BAT pin is less than 2.9V, the charger enters trickle charge mode. In this mode, the LP4060A supplies approximately 1/10 the programmed charge current to bring the battery voltage up to a safe level for full current charging. (Note: The LP4060AX does not include this trickle charge feature).

When the BAT pin voltage rises above 2.9V, the charger enters constant-current mode, where the programmed charge current is supplied to the battery. When the BAT pin approaches the final float voltage (4.2V), the LP4060A enters constant-voltage mode and the charge current begins to decrease. When the charge current drops to 1/10 of the programmed value, the charge cycle ends.

Programming Charge Current

The charge current is programmed using a single resistor from the PROG pin to ground. The battery charge current is 1000 times the current out of the PROG pin. The program resistor and the charge current are calculated using the following equations:

$$R_{SET} = 830 / I_{SET}$$

The charge current out of the BAT pin can be determined at any time by monitoring the PROG pin voltage using the following equation:

$$I_{SET} = 830 / R_{SET}$$

Charge Termination

A charge cycle is terminated when the charge current

falls to 1/10th the programmed value after the final float voltage is reached. This condition is detected by using an internal, filtered comparator to monitor the PROG pin. When the PROG pin voltage falls below 100mV for longer than tTERM (typically 1ms), charging is terminated. The charge current is latched off and the LP4060A enters standby mode, where the input supply current drops to 200 μ A. When charging, transient loads on the BAT pin can cause the PROG pin to fall below 100mV for short periods of time before the DC charge current has dropped to 1/10th the programmed value. The 1ms filter time (TTERM) on the termination comparator ensures that transient loads of this nature do not result in premature charge cycle termination. Once the average charge current drops below 1/10th the programmed value, the LP4060A terminates the charge cycle and ceases to provide any current through the BAT pin. In this state, all loads on the BAT pin must be supplied by the battery. The LP4060A constantly monitors the BAT pin voltage in standby mode. If this voltage drops below the 4.05V recharge threshold (VRECHRG), another charge cycle begins and current is once again supplied to the battery. To manually restart a charge cycle when in standby mode, the input voltage must be removed and reapplied, or the charger must be shut down and restarted using the PROG pin. Figure 7 shows the state diagram of a typical charge cycle.

Charge Status Indicator(CHRG)

The charge status output has three different states: strong pull-down (~10mA), weak pull-down (~12 μ A) and high impedance. The strong pull-down state indicates that the LP4060A is in a charge cycle. Once the charge cycle has terminated, the pin state is determined by undervoltage lockout conditions. A weak pull-down indicates that VCC meets the UVLO conditions and the LP4060A is ready to charge. High impedance indicates that the LP4060A is in undervoltage lockout mode: either VCC is less than 100mV above the BAT pin voltage or insufficient voltage is applied to the VCC pin. A microprocessor can be used to distinguish between these three states –this method is discussed in the Applications Information section.

Charge Termination

An internal thermal feedback loop reduces the programmed charge current if the die temperature

attempts to rise above a preset value of approximately 120°C. This feature protects the LP4060A from excessive temperature and allows the user to push the limits of the power handling capability of a given circuit board without risk of damaging the LP4060A. The charge current can be set according to typical (not worst-case) ambient temperature with the assurance that the charger will automatically reduce the current in worst-case conditions. ThinSOT power considerations are discussed further in the Applications Information section.

Undervoltage Lockout (UVLO)

An internal undervoltage lockout circuit monitors the input voltage and keeps the charger in shutdown mode until VCC rises above the undervoltage lockout threshold. The UVLO circuit has a built-in hysteresis of 200mV. Furthermore, to protect against reverse current in the power MOSFET, the UVLO circuit keeps the charger in shutdown mode if VCC falls to within 30mV of the battery voltage. If the UVLO comparator is tripped, the charger will not come out of shutdown mode until VCC rises 100mV above the battery voltage.

Manual Shutdown

At any point in the charge cycle, the LP4060A can be put into shutdown mode by removing RPROG thus floating the PROG pin. This reduces the battery drain current to less than 2µA and the supply current to less than 50µA. A new charge cycle can be initiated by reconnecting the program resistor. In manual shutdown, the CHRG pin is in a weak pull-down state as long as VCC is high enough to exceed the UVLO conditions. The CHRG pin is in a high impedance state if the LP4060A is in under voltage lockout mode: either VCC is within 100mV of the BAT pin voltage or insufficient voltage is applied to the VCC pin.

Automatic Recharge

Once the charge cycle is terminated, the LP4060A continuously monitors the voltage on the BAT pin using a comparator with a 2ms filter time (TRECHARGE). A charge cycle restarts when the battery voltage falls below 4.05V (which corresponds to approximately 80% to 90% battery capacity). This

ensures that the battery is kept at or near a fully charged condition and eliminates the need for periodic charge cycle initiations. CHRG output enters a strong pull-down state during recharge cycles.

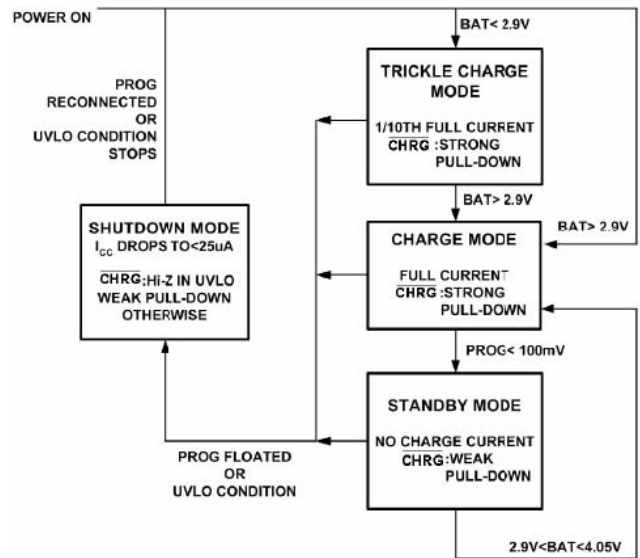

Figure 7. State Diagram of a Typical Charge Cycle

Application Information

Stability Considerations

The constant-voltage mode feedback loop is stable without an output capacitor provided a battery is connected to the charger output. With no battery present, an output capacitor is recommended to reduce ripple voltage. When using high value, low ESR ceramic capacitors, it is recommended to add a 1Ω resistor in series with the capacitor. No series resistor is needed if tantalum capacitors are used. In constant-current mode, the PROG pin is in the feedback loop, not the battery. The constant-current mode stability is affected by the impedance at the PROG pin. With no additional capacitance on the PROG pin, the charger is stable with program resistor values as high as 20k. However, additional capacitance on this node reduces the maximum allowed program resistor. The pole frequency at the PROG pin should be kept above 100kHz. Therefore, if the PROG pin is loaded with a capacitance, PROG, the following equation can be used to calculate the maximum resistance value for RPROG:

$$R_{\text{PROG}} \leq \frac{1}{2\pi \cdot 10^5 \cdot C_{\text{PROG}}}$$

Average, rather than instantaneous, charge current may be of interest to the user. For example, if a switching power supply operating in low current mode is connected in parallel with the battery, the average current being pulled out of the BAT pin is typically of more interest than the instantaneous current pulses. In such a case, a simple RC filter can be used on the PROG pin to measure the average battery current as shown in Figure 8. A 10k resistor has been added between the PROG pin and the filter capacitor to ensure stability.

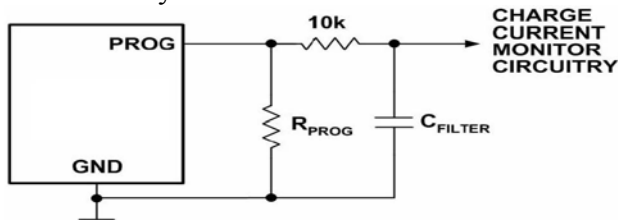

Figure 8. Isolating Capacitive Load on PROG Pin and Filtering

Power Dissipation

The conditions that cause the LP4060A to reduce charge current through thermal feedback can be approximated by considering the power dissipated in the IC. Nearly all of this power dissipation is generated by the internal MOSFET—this is calculated to be approximately:

$$P_D = (V_{CC} - V_{BAT}) \cdot I_{BAT}$$

where PD is the power dissipated, VCC is the input supply voltage, VBAT is the battery voltage and IBAT is the charge current. The approximate ambient temperature at which the thermal feedback begins to protect the IC is:

$$T_A = 120^\circ\text{C} - P_D \theta_{JA}$$

$$T_A = 120^\circ\text{C} - (V_{CC} - V_{BAT}) \cdot I_{BAT} \cdot \theta_{JA}$$

Example: An LP4060A operating from a 5V USB supply is programmed to supply 400mA full-scale current to a discharged Li-Ion battery with a voltage of 3.75V. Assuming θ_{JA} is 150 °C /W (see Board Layout Considerations), the ambient temperature at which the LP4060A will begin to

reduce the charge current is approximately:

$$T_A = 120^\circ\text{C} - (5\text{V} - 3.75\text{V}) \cdot (400\text{mA}) \cdot 150^\circ\text{C/W}$$

$$T_A = 120^\circ\text{C} - 0.5\text{W} \cdot 150^\circ\text{C/W} = 120^\circ\text{C} - 75^\circ\text{C}$$

$$T_A = 45^\circ\text{C}$$

The LP4060A can be used above 45°C ambient, but the charge current will be reduced from 400mA. The approximate current at a given ambient temperature can be approximated by:

$$I_{BAT} = \frac{120^\circ\text{C} - T_A}{(V_{CC} - V_{BAT}) \cdot \theta_{JA}}$$

Using the previous example with an ambient temperature of 60°C, the charge current will be reduced to approximately:

$$I_{BAT} = \frac{120^\circ\text{C} - 60^\circ\text{C}}{(5\text{V} - 3.75\text{V}) \cdot 150^\circ\text{C/W}} = \frac{60^\circ\text{C}}{187.5^\circ\text{C/A}}$$

$$I_{BAT} = 320\text{mA}$$

Moreover, when thermal feedback reduces the charge current, the voltage at the PROG pin is also reduced proportionally as discussed in the Operation section. It is important to remember that LP4060A applications do not need to be designed for worst-case thermal conditions since the IC will automatically reduce power dissipation when the junction temperature reaches approximately 120°C.

Thermal Considerations

Because of the small size of the ThinSOT package, it is very important to use a good thermal PC board layout to maximize the available charge current. The thermal path for the heat generated by the IC is from the die to the copper lead frame, through the package leads, (especially the ground lead) to the PC board copper. The PC board copper is the heat sink. The footprint copper pads should be as wide as One method is by dissipating some of the power through an external component, such as a resistor or diode. Example: An LP4060A operating from a 5V wall adapter is programmed to supply 800mA full-scale current to a discharged Li-Ion battery with a voltage of 3.75V. Assuming θ_{JA} is 125°C/W, the approximate charge current at an ambient temperature of 25 °C is:

$$I_{BAT} = \frac{120^{\circ}\text{C} - 25^{\circ}\text{C}}{(5\text{V} - 3.75\text{V}) \cdot 125^{\circ}\text{C} / \text{W}} = 608\text{mA}$$

By dropping voltage across a resistor in series with a 5V wall adapter (shown in Figure 9), the on-chip power dissipation can be decreased, thus increasing the thermally regulated charge current.:

$$I_{BAT} = \frac{120^{\circ}\text{C} - 25^{\circ}\text{C}}{(V_S - I_{BAT}R_{CC} - V_{BAT}) \cdot \theta_{JA}}$$

Solving for I_{BAT} using the quadratic formula

$$I_{BAT} = \frac{(V_S - V_{BAT}) - \sqrt{(V_S - V_{BAT})^2 - \frac{4R_{CC}(120^{\circ}\text{C} - T_A)}{\theta_{JA}}}}{2R_{CC}}$$

Using $R_{CC} = 0.25\Omega$, $V_S = 5\text{V}$, $V_{BAT} = 3.75\text{V}$, $T_A = 25^{\circ}\text{C}$ and $\theta_{JA} = 125^{\circ}\text{C}/\text{W}$ we can calculate the thermally regulated charge current to be:

$$I_{BAT} = 708.4\text{mA}$$

While this application delivers more energy to the battery and reduces charge time in thermal mode, it may actually lengthen charge time in voltage mode if VCC becomes low enough to put the LP4060A into dropout. This technique works best when RCC values are minimized to keep component size small and avoid dropout. Remember to choose a resistor with adequate power handling capability.

VCC Bypass Capacitor

Many types of capacitors can be used for input bypassing, however, caution must be exercised when using multilayer ceramic capacitors. Because of the self-resonant and high Q characteristics of some types of ceramic capacitors, high voltage transients can be generated under some start-up conditions, such as connecting the charger input to a live power source. Adding a 1.5Ω resistor in series with an X5R ceramic capacitor will minimize start-up voltage transients.

Charge Current Soft-Start

The LP4060A includes a soft-start circuit to minimize the inrush current at the start of a charge cycle. When a charge cycle is initiated, the charge current ramps from zero to the full-scale current over a period of approximately 100μs. This has

the effect of minimizing the transient current load on the power supply during start-up.

CHRG Status Output Pin

The CHRG pin can provide an indication that the input voltage is greater than the undervoltage lockout threshold level. A weak pull-down current of approximately 12μA indicates that sufficient voltage is applied to VCC to begin charging. When a discharged battery is connected to the charger, the constant current portion of the charge cycle begins and the CHRG pin pulls to ground. The CHRG pin can sink up to 10mA to drive an LED that indicates that a charge cycle is in progress. When the battery is nearing full charge, the charger enters the constant-voltage portion of the charge cycle and the charge current begins to drop. When the charge current drops below 1/10 of the programmed current, the charge cycle ends and the strong pull-down is replaced by the 12μA pull-down, indicating that the charge cycle has ended. If the input voltage is removed or drops below the under voltage lockout threshold, the CHRG pin becomes high impedance. Figure 10 shows that by using two different value pull-up resistors, a micro-processor can detect all three states from this pin.

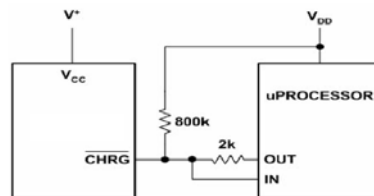

Figure 10. Using a Microprocessor to Determine CHRG State

To detect when the LP4060A is in charge mode, force the digital output pin (OUT) high and measure the voltage at the CHRG pin. The N-channel MOSFET will pull the pin voltage low even with the 2k pull-up resistor. Once the charge cycle terminates, the N-channel MOSFET is turned off and a 12μA current source is connected to the CHRG pin. The IN pin will then be pulled high by the 2k pull-up resistor. To determine if there is a weak pull-down current, the OUT pin should be forced to a high impedance state. The weak current source will pull the IN pin low through the 800k resistor; if CHRG is high impedance, the IN pin will be pulled high, indicating that the part is in a UVLO state.

Reverse Polarity Input Voltage Protection

In some applications, protection from reverse polarity voltage on VCC is desired. If the supply voltage is high enough, a series blocking diode can be used. In other cases, where the voltage drop must be kept low a P-channel MOSFET can be used (as shown in Fig 11.)

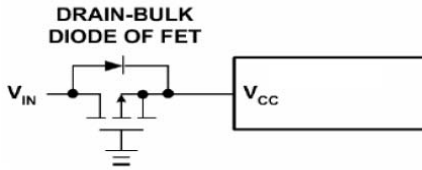

Figure 11. Low Loss Input Reverse Polarity Protection

USB and Wall Adapter Power

The LP4060A allows charging from both a wall adapter and a USB port. Figure 12 shows an example of how to combine wall adapter and USB power inputs. A P-channel MOSFET,

MP1, is used to prevent back conducting into the USB port when a wall adapter is present and a Schottky diode, D1, is used to prevent USB power loss through the 1k pull-down resistor. Typically a wall adapter can supply more current than the 500mA-limited USB port. Therefore, an N-channel MOSFET, MN1, and extra 10k program resistor are used to increase the charge current to 800mA when the wall adapter is present.

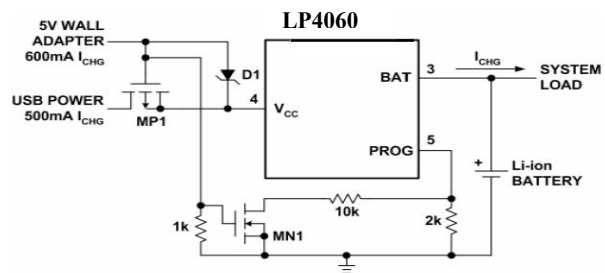

Figure 12. Combining Wall Adapter and USB Power

Layout Considerations

- ✧ Follow the PCB layout guidelines for optimal performance of LP4060A.
- ✧ For the main current paths as indicated in bold lines, keep their traces short and wide.
- ✧ Put the input capacitor as close as possible to the device pins (VIN and GND).
- ✧ Connect all analog grounds to a command node and then connect the command node to the power ground behind the output capacitors.
- ✧ Output not connect loading when charging

Packaging Information

SOT23-5

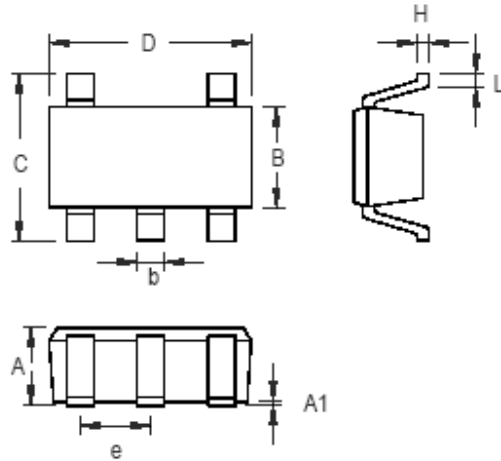

Symbol	Dimensions In Millimeters		Dimensions In Inches	
	Min	Max	Min	Max
A	0.889	1.295	0.035	0.051
A1	0.000	0.152	0.000	0.006
B	1.397	1.803	0.055	0.071
b	0.356	0.559	0.014	0.022
C	2.591	2.997	0.102	0.118
D	2.692	3.099	0.106	0.122
e	0.838	1.041	0.033	0.041
H	0.080	0.254	0.003	0.010
L	0.300	0.610	0.012	0.024

SOT-23-5 Surface Mount Package