

512Kb (32K x 16) Static RAM

Features

- **Temperature Range**
 - Automotive: -40°C to 125°C
- **High speed**
 - $t_{AA} = 15 \text{ ns}$
- **Optimized voltage range: 2.5V–2.7V**
- **Automatic power-down when deselected**
- **Independent control of upper and lower bits**
- **CMOS for optimum speed/power**
- **Package offered: 44-pin TSOP II**

Functional Description

The CY7C1020CV26 is a high-performance CMOS static RAM organized as 32,768 words by 16 bits. This device has an automatic power-down feature that significantly reduces power consumption when deselected.

Writing to the device is accomplished by taking Chip Enable (\overline{CE}) and Write Enable (\overline{WE}) inputs LOW. If Byte Low Enable (\overline{BLE}) is LOW, then data from I/O pins (I/O_1 through I/O_8), is written into the location specified on the address pins (A_0 through A_{14}). If Byte High Enable (\overline{BHE}) is LOW, then data from I/O pins (I/O_9 through I/O_{16}) is written into the location specified on the address pins (A_0 through A_{14}).

Reading from the device is accomplished by taking Chip Enable (\overline{CE}) and Output Enable (\overline{OE}) LOW while forcing the Write Enable (\overline{WE}) HIGH. If Byte Low Enable (\overline{BLE}) is LOW, then data from the memory location specified by the address pins will appear on I/O_1 to I/O_8 . If Byte High Enable (\overline{BHE}) is LOW, then data from memory will appear on I/O_9 to I/O_{16} . See the truth table at the back of this data sheet for a complete description of read and write modes.

The input/output pins (I/O_1 through I/O_{16}) are placed in a high-impedance state when the device is deselected (\overline{CE} HIGH), the outputs are disabled (\overline{OE} HIGH), the \overline{BHE} and \overline{BLE} are disabled (\overline{BHE} , \overline{BLE} HIGH), or during a write operation (\overline{CE} LOW, and \overline{WE} LOW).

The CY7C1020CV26 is available in standard 44-pin TSOP Type II.

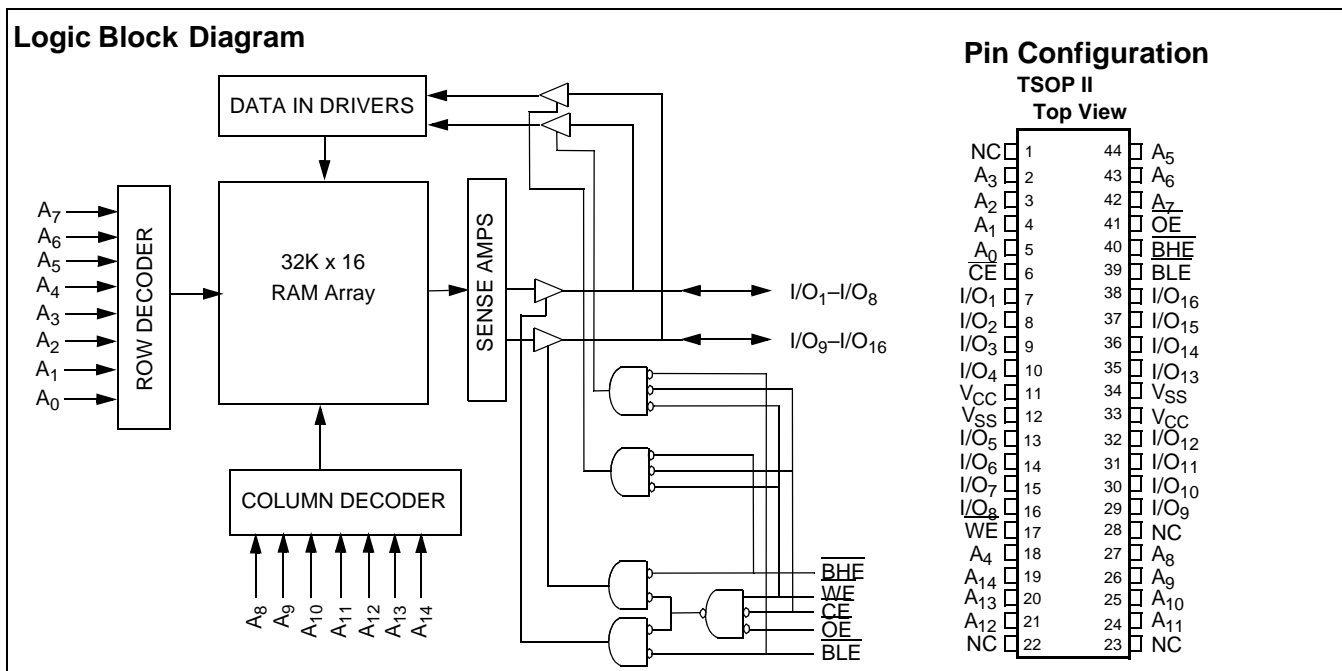

Selection Guide

	CY7C1020CV26-15	Unit
Maximum Access Time	15	ns
Maximum Operating Current	100	mA
Maximum CMOS Standby Current	5	mA

Maximum Ratings

(Above which the useful life may be impaired. For user guidelines, not tested.)

Storage Temperature -65°C to +150°C
 Ambient Temperature with Power Applied -55°C to +125°C
 Supply Voltage on V_{CC} to Relative GND^[1] -0.5V to +4.6V
 DC Voltage Applied to Outputs in High-Z State^[1] -0.5V to V_{CC}+0.5V

DC Input Voltage^[1] -0.5V to V_{CC}+0.5V
 Current into Outputs (LOW) 20 mA
 Static Discharge Voltage > 2001V (per MIL-STD-883, Method 3015)
 Latch-up Current > 200 mA

Operating Range

Range	Ambient Temperature	V _{CC}
Automotive	-40°C to +125°C	2.5V to 2.7V

Electrical Characteristics Over the Operating Range

Parameter	Description	Test Conditions	CY7C1020CV26		Unit
			Min.	Max.	
V _{OH}	Output HIGH Voltage	V _{CC} = Min., I _{OH} = -1.0 mA	2.3		V
V _{OL}	Output LOW Voltage	V _{CC} = Min., I _{OL} = 1.0 mA		0.4	V
V _{IH}	Input HIGH Voltage		2.0	V _{CC} + 0.3	V
V _{IL}	Input LOW Voltage ^[1]		-0.3	0.8	V
I _{IX}	Input Load Current	GND ≤ V _I ≤ V _{CC}	-5	+5	μA
I _{OZ}	Output Leakage Current	GND ≤ V _I ≤ V _{CC} , Output Disabled	-5	+5	μA
I _{OS} ^[2]	Output Short Circuit Current	V _{CC} = Max., V _{OUT} = GND		-300	mA
I _{CC}	V _{CC} Operating Supply Current	V _{CC} = Max., I _{OUT} = 0 mA, f = f _{MAX} = 1/t _{RC}		100	mA
I _{SB1}	Automatic CE Power-Down Current —TTL Inputs	Max. V _{CC} , CE ≥ V _{IH} , V _{IN} ≥ V _{IH} or V _{IN} ≤ V _{IL} , f = f _{MAX}		40	mA
I _{SB2}	Automatic CE Power-down Current —CMOS Inputs	Max. V _{CC} , CE ≥ V _{CC} - 0.3V, V _{IN} ≥ V _{CC} - 0.3V, or V _{IN} ≤ 0.3V, f = 0		5	mA

Capacitance^[3]

Parameter	Description	Test Conditions	Max.	Unit
C _{IN}	Input Capacitance	T _A = 25°C, f = 1 MHz, V _{CC} = 2.6V	8	pF
C _{OUT}	Output Capacitance		8	pF

Notes:

- V_{IL} (min.) = -2.0V for pulse durations of less than 20 ns.
- Not more than one output should be shorted at one time. Duration of the short circuit should not exceed 30 seconds.
- Tested initially and after any design or process changes that may affect these parameters.

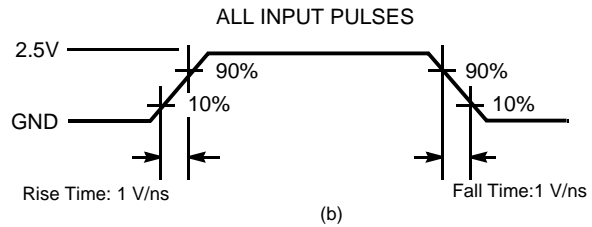
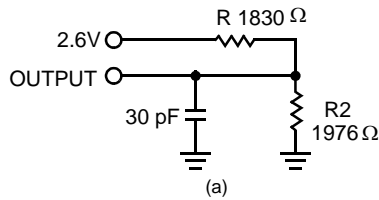
AC Test Loads and Waveforms^[4]

AC Switching Characteristics Over the Operating Range

Parameter	Description	CY7C1020CV26		Unit
		Min.	Max.	
READ CYCLE				
t_{RC}	Read Cycle Time	15		ns
t_{AA}	Address to Data Valid		15	ns
t_{OHA}	Data Hold from Address Change	3		ns
t_{ACE}	\overline{CE} LOW to Data Valid		15	ns
t_{DOE}	\overline{OE} LOW to Data Valid		7	ns
t_{LZOE}	\overline{OE} LOW to Low Z ^[5]	0		ns
t_{HZOE}	\overline{OE} HIGH to High Z ^[5, 6]		7	ns
t_{LZCE}	\overline{CE} LOW to Low Z ^[5]	3		ns
t_{HZCE}	\overline{CE} HIGH to High Z ^[5, 6]		7	ns
t_{PU} ^[7]	\overline{CE} LOW to Power-up	0		ns
t_{PD} ^[7]	\overline{CE} HIGH to Power-down		15	ns
t_{DBE}	Byte Enable to Data Valid		7	ns
t_{LZBE}	Byte Enable to Low Z	0		ns
t_{HZBE}	Byte Disable to High Z		7	ns
WRITE CYCLE^[8]				
t_{WC}	Write Cycle Time	15		ns
t_{SCE}	\overline{CE} LOW to Write End	10		ns
t_{AW}	Address Set-Up to Write End	10		ns
t_{HA}	Address Hold from Write End	0		ns
t_{SA}	Address Set-Up to Write Start	0		ns
t_{PWE}	\overline{WE} Pulse Width	10		ns
t_{SD}	Data Set-Up to Write End	8		ns
t_{HD}	Data Hold from Write End	0		ns
t_{LZWE}	\overline{WE} HIGH to Low Z ^[5]	3		ns
t_{HZWE}	\overline{WE} LOW to High Z ^[5, 6]		4	ns
t_{BW}	Byte Enable to End of Write	10		ns

Notes:

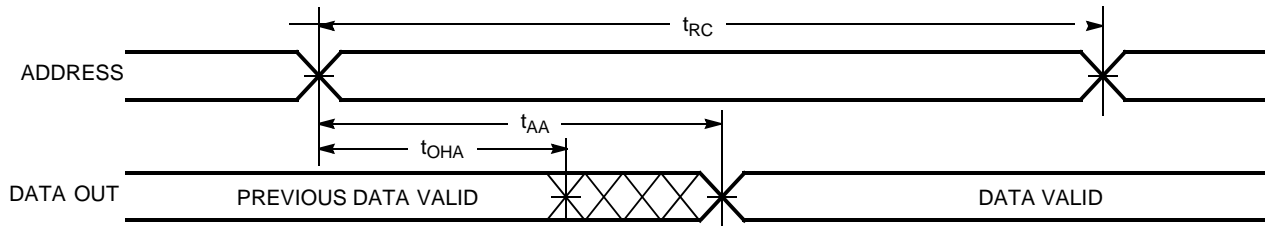
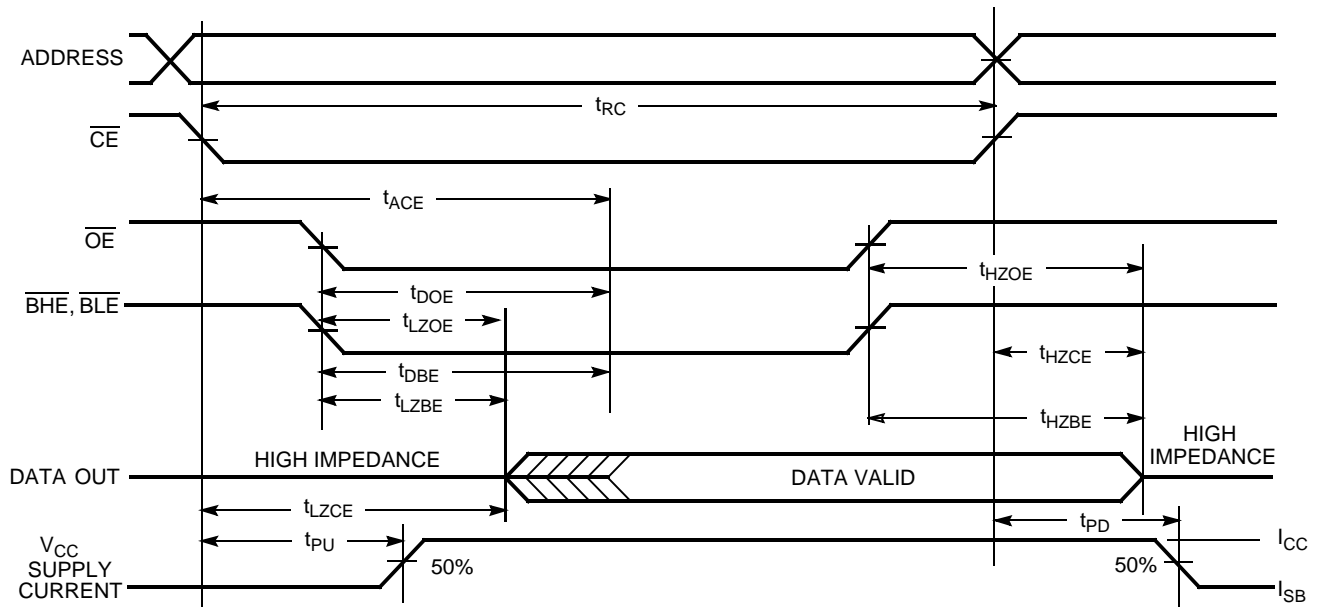
- Test conditions assume signal transition time of 1V/ns or less, timing reference levels of 1.3V, input pulse levels of 0 to 2.5V and transmission line loads as in (a) of AC Test Loads.
- At any given temperature and voltage condition, t_{HZCE} is less than t_{LZCE} , t_{HZOE} is less than t_{LZOE} , and t_{HZWE} is less than t_{LZWE} for any given device.
- t_{HZOE} , t_{HZBE} , t_{HZCE} , and t_{HZWE} are specified with a load capacitance of 5 pF as in (b) of AC Test Loads. Transition is measured ± 500 mV from steady-state voltage.
- This parameter is guaranteed by design and is not tested.
- The internal write time of the memory is defined by the overlap of \overline{CE} LOW, \overline{WE} LOW and $\overline{BHE} / \overline{BLE}$ LOW. \overline{CE} , \overline{WE} and $\overline{BHE} / \overline{BLE}$ must be LOW to initiate a write, and the transition of these signals can terminate the write. The input data set-up and hold timing should be referenced to the leading edge of the signal that terminates the write.

Switching Waveforms
Read Cycle No. 1^[9, 10]

Read Cycle No. 2 (\overline{OE} Controlled)^[10, 11]

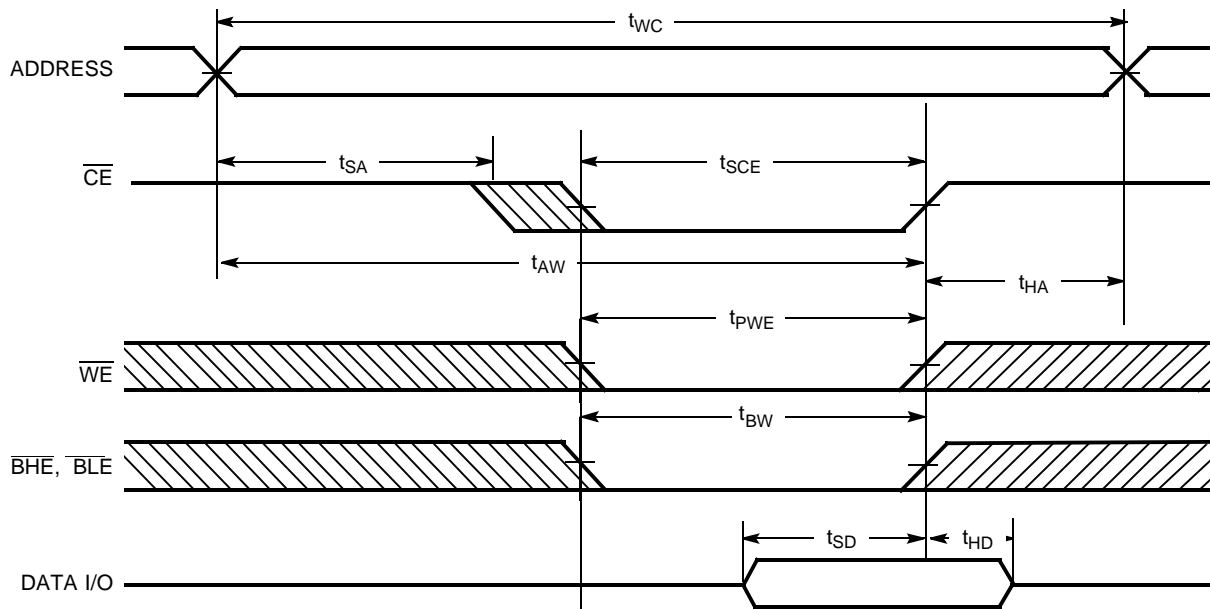
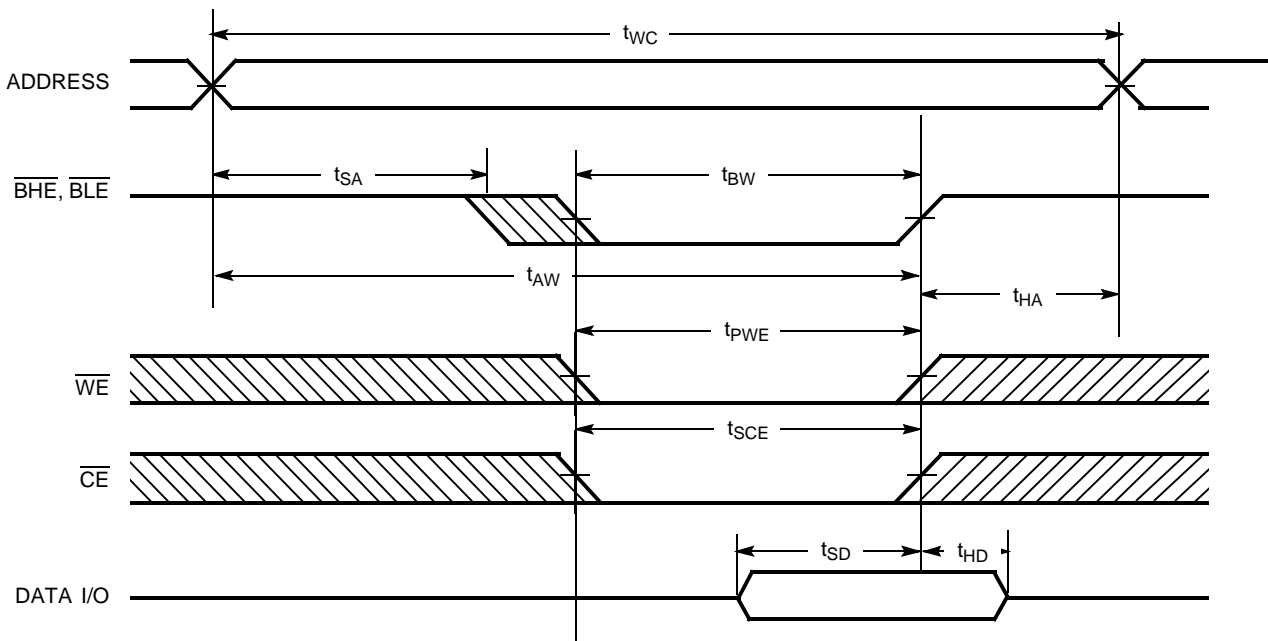
Notes:

9. Device is continuously selected. \overline{OE} , \overline{CE} , \overline{BHE} and/or \overline{BLE} = V_{IL} .
10. \overline{WE} is HIGH for read cycle.
11. Address valid prior to or coincident with \overline{CE} transition LOW.

Switching Waveforms
Write Cycle No. 1 (\overline{CE} Controlled)^[12, 13]

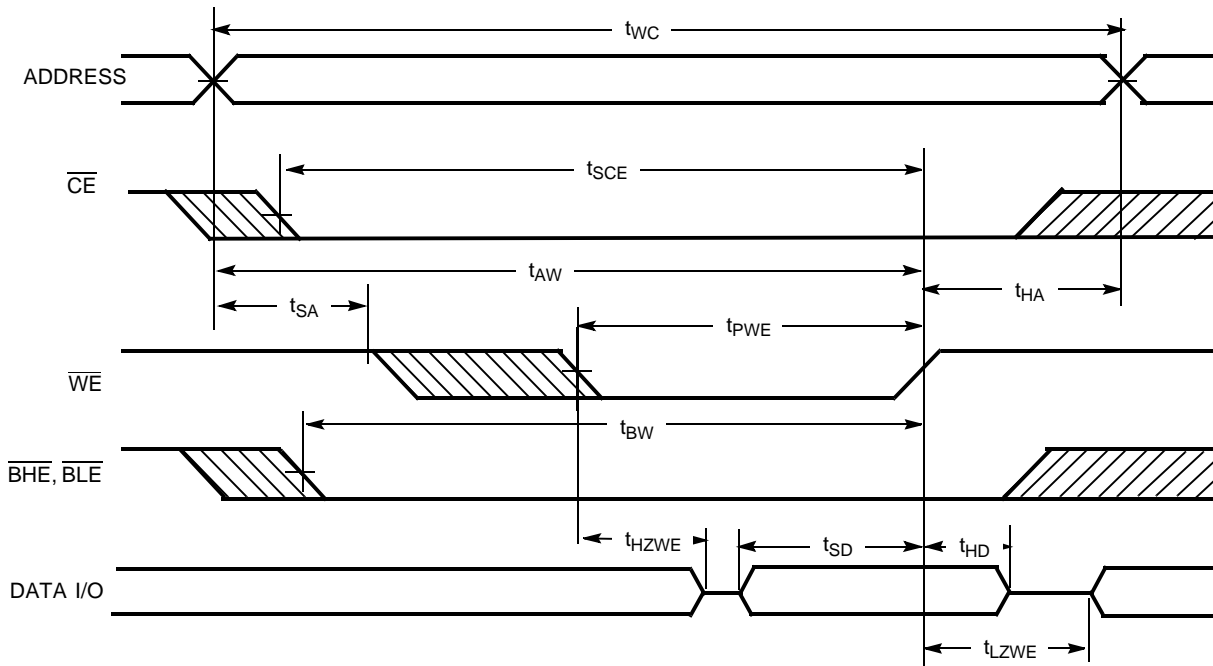
Write Cycle No. 2 (\overline{BLE} or \overline{BHE} Controlled)

Notes:

12. Data I/O is high impedance if \overline{OE} or \overline{BHE} and $\overline{BLE} = V_{IH}$.

13. If \overline{CE} goes HIGH simultaneously with \overline{WE} going HIGH, the output remains in a high-impedance state.

Switching Waveforms
Write Cycle No. 3 (\overline{WE} Controlled, \overline{OE} LOW)

Truth Table

\overline{CE}	\overline{OE}	\overline{WE}	\overline{BLE}	\overline{BHE}	I/O ₁ -I/O ₈	I/O ₉ -I/O ₁₆	Mode	Power
H	X	X	X	X	High Z	High Z	Power-down	Standby (I_{SB})
L	L	H	L	L	Data Out	Data Out	Read – All bits	Active (I_{CC})
			L	H	Data Out	High Z	Read – Lower bits only	Active (I_{CC})
			H	L	High Z	Data Out	Read – Upper bits only	Active (I_{CC})
L	X	L	L	L	Data In	Data In	Write – All bits	Active (I_{CC})
			L	H	Data In	High Z	Write – Lower bits only	Active (I_{CC})
			H	L	High Z	Data In	Write – Upper bits only	Active (I_{CC})
L	H	H	X	X	High Z	High Z	Selected, Outputs Disabled	Active (I_{CC})
L	X	X	H	H	High Z	High Z	Selected, Outputs Disabled	Active (I_{CC})

Ordering Information

Speed (ns)	Ordering Code	Package Name	Package Type	Operating Range
15	CY7C1020CV26-15ZSXE	Z44	44-Lead TSOP Type II (Pb-Free)	Automotive

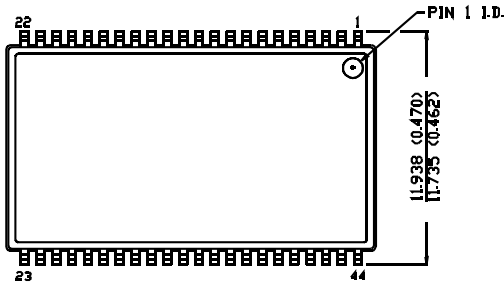
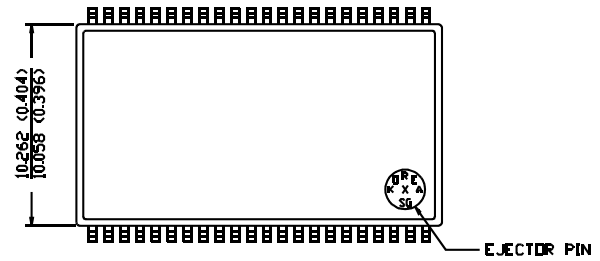
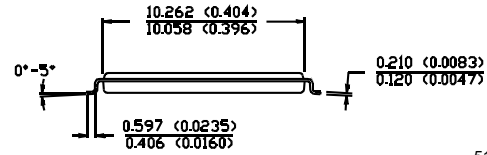
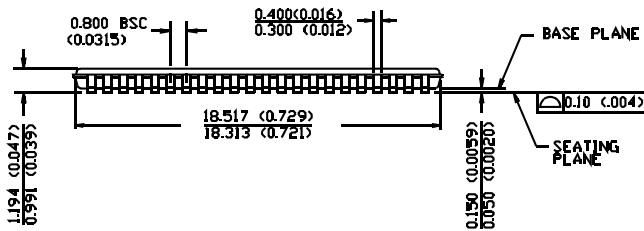
Package Diagrams
44-Pin TSOP II Z44

 DIMENSION IN MM (INCH)
 MAX
 MIN

TOP VIEW

BOTTOM VIEW

51-85087-A

All product and company names mentioned in this document are the trademarks of their respective holders.

Document History Page

Document Title: CY7C1020CV26 512Kb (32K x 16) Static RAM				
Document Number: 38-05406				
REV.	ECN NO.	Issue Date	Orig. of Change	Description of Change
**	128060	07/30/03	EJH	Customized data sheet to meet special requirements for CG5988AF Automotive temperature range: -40°C / +125°C
*A	352999	See ECN	SYT	Removed 'CG5988AF' from the Datasheet Edited the features section for better structure on Page 1 Edited the title to include the mention of '512Kb'