

10MHz, 6V/ μ s, Quad Rail-to-Rail Input and Output Precision C-Load Op Amp

DESCRIPTION

The RH1499 is a quad, rail-to-rail input and output precision C-Load™ op amp with a 10MHz gain-bandwidth product and a 6V/ μ s slew rate.

The RH1499 is designed to maximize input dynamic range by delivering precision performance over the full supply voltage. Using a patented technique, the input stages of the RH1499 are trimmed, one at the negative supply and the other at the positive supply. The resulting guaranteed common mode rejection is much better than other rail-to-rail input op amps. When used as a unity-gain buffer in front of single supply 12-bit A-to-D converters, the RH1499 is guaranteed to add less than 1LSB of error even in single 3V supply systems.

With 110dB of supply rejection, the RH1499 maintains its performance over a supply range of 2.2V to 36V. The inputs can be driven beyond the supplies without damage or phase reversal of the output. These op amps remain stable while driving capacitive loads up to 10,000pF.

The wafer lots are processed to Linear Technology's in-house Class S flow to yield circuits usable in stringent military and space applications.

LT, LT, LTC and LTM are registered trademarks of Linear Technology Corporation. C-Load is a trademark of Linear Technology Corporation. All other trademarks are the property of their respective owners.

ABSOLUTE MAXIMUM RATINGS

(Note 1)

Total Supply Voltage (V^+ to V^-)	36V
Input Current.....	$\pm 10\text{mA}$
Output Short-Circuit Duration (Note 2)	Continuous
Operating Temperature Range.....	-55°C to 125°C
Specified Temperature Range	-55°C to 125°C
Junction Temperature	150°C
Storage Temperature Range.....	-65°C to 150°C
Lead Temperature (Soldering, 10 sec)	300°C

BURN-IN CIRCUIT

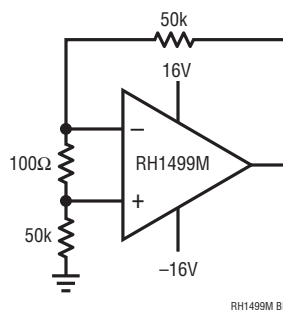

PACKAGE INFORMATION

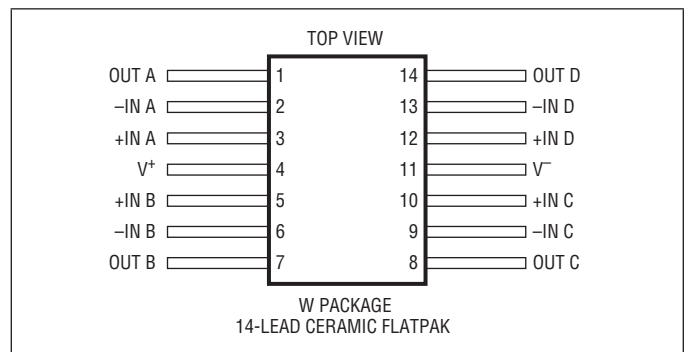

TABLE 1: ELECTRICAL CHARACTERISTICS(Preirradiation) $V_S = \pm 15V$, $V_{CM} = V_{OUT} = 0V$, unless otherwise noted.

SYMBOL	PARAMETER	CONDITIONS	NOTES	$T_A = 25^\circ C$			SUB-GROUP	$-55^\circ C \leq T_A \leq 125^\circ C$			SUB-GROUP	UNITS	
				MIN	TYP	MAX		MIN	TYP	MAX			
V_{OS}	Input Offset Voltage	$V_{CM} = V^+, V^-$ $V_{CM} = 14.5V, -14.5V$			200	800	1		350	1100	2, 3	μV μV	
	Input Offset Voltage Match (Channel-to-Channel) (Note 3)	$V_{CM} = V^+ \text{ to } V^-$ $V_{CM} = 14.5V \text{ to } -14.5V$	3		250	1400			450	1800		μV μV	
I_B	Input Bias Current	$V_{CM} = V^+$ $V_{CM} = 14.5V$ $V_{CM} = V^-$ $V_{CM} = -14.5V$		0	250	715	1		500	1200	2, 3	nA nA nA nA	
	Input Bias Current Match (Channel-to-Channel) (Note 3)	$V_{CM} = V^+, V^-$ $V_{CM} = 14.5V, -14.5V$	3	0	12	200			50	400		nA nA	
I_{OS}	Input Offset Current	$V_{CM} = V^+, V^-$ $V_{CM} = 14.5V, -14.5V$			6	70	1		40	300	2, 3	nA nA	
	Input Voltage Range			-15		15		-14.5		14.5		V	
	Input Noise Voltage	0.1Hz to 10Hz			400							nV _{p-p}	
e_n	Input Noise Voltage Density	$f = 1kHz$			12							nV/ \sqrt{Hz}	
i_n	Input Noise Current Density	$f = 1kHz$			0.3							pA/ \sqrt{Hz}	
A_{VOL}	Large-Signal Voltage Gain	$V_O = -14.5V \text{ to } 14.5V$, $R_L = 10k$ $V_O = -10V \text{ to } 10V$, $R_L = 2k$		1000	5200		4	60	400		5, 6	V/mV V/mV	
				500	2300			25	100				
CMRR	Common Mode Rejection Ratio	$V_{CM} = V^+ \text{ to } V^-$ $V_{CM} = 14.5V \text{ to } -14.5V$		90	102		1	86	102		2, 3	dB dB	
	CMRR Match (Channel-to-Channel) (Note 3)	$V_{CM} = V^+ \text{ to } V^-$ $V_{CM} = 14.5V \text{ to } -14.5V$	3	84	103			80	100			dB dB	
PSRR	Power Supply Rejection Ratio	$V_S = \pm 2V \text{ to } \pm 16V$		90	110		1	88	100		2, 3	dB	
	PSRR Match (Channel-to-Channel) (Note 3)	$V_S = \pm 2V \text{ to } \pm 16V$	3	83	110			82	100			dB	
V_{OL}	Output Voltage Swing (Low) (Note 4)	No Load $I_{SINK} = 1mA$ $I_{SINK} = 10mA$ $I_{SINK} = 5mA$	4		18	30	4	25	75	70	150	5, 6	mV mV mV mV
					230	500		180	500				
V_{OH}	Output Voltage Swing (High) (Note 4)	No Load $I_{SINK} = 1mA$ $I_{SINK} = 10mA$ $I_{SINK} = 5mA$	4		2.5	10	4	5	25	100	250	5, 6	mV mV mV mV
					75	150		300	800				
I_{SC}	Short-Circuit Current			± 15	± 30		1	± 7.5	± 12		2, 3	mA	
I_S	Supply Current per Amp				1.8	2.5	1		2.2	3	2, 3	mA	
GBW	Gain-Bandwidth Product	$f = 100kHz$		6.8	10.5			5.8	8.5			MHz	
SR	Slew Rate	$A_V = -1$, $R_L = 2k$, $V_O = \pm 10V$, Measure at $V_O = \pm 5V$		3.5	6		4	2.2	4		5, 6	V/ μs	

TABLE 1A: ELECTRICAL CHARACTERISTICS(Postirradiation) $V_S = \pm 15V$, $V_{CM} = 0V$, $T_A = 25^\circ C$, unless otherwise noted.

SYMBOL	PARAMETER	CONDITIONS	NOTES	10Krad (Si)		20Krad (Si)		50Krad (Si)		100Krad (Si)		200Krad (Si)		UNITS
				MIN	MAX	MIN	MAX	MIN	MAX	MIN	MAX	MIN	MAX	
V_{OS}	Input Offset Voltage	$V_{CM} = V^+, V^-$		950		950		950		950		950		μV
I_B	Input Bias Current	$V_{CM} = V^+, V^-$		765		815		865		915		965		nA
I_{OS}	Input Offset Current	$V_{CM} = V^+, V^-$		100		100		100		100		100		nA
	Input Voltage Range			V^-	V^+	V^-	V^+	V^-	V^+	V^-	V^+	V^-	V^+	V
A_{VOL}	Large-Signal Voltage Gain	$V_O = -14.5V$ to $14.5V$, $R_L = 10k$		500		500		500		500		500		V/mV
		$V_O = -10V$ to $10V$, $R_L = 2k$		250		250		250		250		250		V/mV
CMRR	Common Mode Rejection Ratio	$V_{CM} = V^+$ to V^-		86		86		86		86		86		dB
	CMRR Match (Channel-to-Channel)	$V_{CM} = V^+$ to V^-	3	83		83		83		83		83		dB
PSRR	Power Supply Rejection Ratio	$V_S = \pm 2V$ to $\pm 16V$		90		90		90		90		90		dB
	PSRR Match (Channel-to-Channel)	$V_S = \pm 2V$ to $\pm 16V$	3	83		83		83		83		83		dB
V_{OUT}	Output Voltage Swing Low	No Load	4	60		60		60		60		60		mV
		$I_{SINK} = 1mA$		100		100		100		100		100		mV
		$I_{SINK} = 10mA$		500		500		500		500		500		mV
	Output Voltage Swing High	No Load	4	20		20		20		20		20		mV
$I_{SINK} = 1mA$	150			150		150		150		150		mV		
$I_{SINK} = 10mA$	800			800		800		800		800		mV		
I_{SC}	Short-Circuit Current			± 10		± 10		± 10		± 10		± 10		mA
I_S	Supply Current			2.5		2.5		2.5		2.5		2.5		mA
GBW	Gain-Bandwidth Product	$f = 100kHz$		4.5		4.5		4.5		4.5		4.5		MHz
SR	Slew Rate	$A_V = -1$, $R_L = 10k$, $V_O = \pm 10V$, Measure at $V_O = \pm 5V$		3		3		3		3		3		V/ μs

TABLE 2: ELECTRICAL CHARACTERISTICS(Preirradiation) $V_S = 3V, 5V$; $V_{CM} = V_{OUT} = \text{half supply}$, unless otherwise noted.

SYMBOL	PARAMETER	CONDITIONS	NOTES	$T_A = 25^\circ\text{C}$			SUB-GROUP	$-55^\circ\text{C} \leq T_A \leq 125^\circ\text{C}$			SUB-GROUP	UNITS
				MIN	TYP	MAX		MIN	TYP	MAX		
V_{OS}	Input Offset Voltage	$V_{CM} = V^+, V^-$ $V_{CM} = V^+ - 0.5V, V^- + 0.5V$			150	800	1		300	1100	2, 3	μV μV
	Input Offset Voltage Match (Channel-to-Channel) (Note 3)	$V_{CM} = V^+ \text{ to } V^-$ $V_{CM} = V^+ - 0.5V, V^- + 0.5V$	3		200	1400			350	1800		μV μV
I_B	Input Bias Current	$V_{CM} = V^+$ $V_{CM} = V^+ - 0.5V$ $V_{CM} = V^-$ $V_{CM} = V^- + 0.5V$		0	250	650	1	0	450	1100	2, 3	nA nA nA nA
	Input Bias Current Match (Channel-to-Channel) (Note 3)	$V_{CM} = V^+, V^-$ $V_{CM} = V^+ - 0.5V, V^- + 0.5V$	3	0	10	180		0	30	400		nA nA
I_{OS}	Input Offset Current	$V_{CM} = V^+, V^-$ $V_{CM} = V^+ - 0.5V, V^- + 0.5V$			5	65	1		15	300	2, 3	nA nA
	Input Voltage Range			V^-		V^+		$V^- + 0.5V$		$V^+ - 0.5V$		V
	Input Noise Voltage	0.1Hz to 10Hz			400							nV _{p-p}
e_n	Input Noise Voltage Density	$f = 1\text{kHz}$			12							nV/ $\sqrt{\text{Hz}}$
i_n	Input Noise Current Density	$f = 1\text{kHz}$			0.3							pA/ $\sqrt{\text{Hz}}$
C_{IN}	Input Capacitance				5							pF
A_{VOL}	Large-Signal Voltage Gain	$V_S = 5V, V_O = 75\text{mV to } 4.8V,$ $R_L = 10k$		600	3800		4	60	210		5, 6	V/mV V/mV
		$V_S = 3V, V_O = 75\text{mV to } 2.8V,$ $R_L = 10k$		500	2000			25	210			
CMRR	Common Mode Rejection Ratio	$V_S = 5V, V_{CM} = V^+ \text{ to } V^-$ $V_S = 3V, V_{CM} = V^+ \text{ to } V^-$ $V_S = 5V, V_{CM} = 0.5V \text{ to } 4.5V$ $V_S = 3V, V_{CM} = 0.5V \text{ to } 2.5V$		76	90		1				2, 3	dB dB dB dB
	CMRR Match (Channel-to-Channel) (Note 3)	$V_S = 5V, V_{CM} = V^+ \text{ to } V^-$ $V_S = 3V, V_{CM} = V^+ \text{ to } V^-$ $V_S = 5V, V_{CM} = 0.5V \text{ to } 4.5V$ $V_S = 3V, V_{CM} = 0.5V \text{ to } 2.5V$	3	75	91		1				2, 3	dB dB dB dB
PSRR	Power Supply Rejection Ratio	$V_S = 2.2V \text{ to } 12V,$ $V_{CM} = V_O = 0.5V$		88	105		1	86	104		2, 3	dB
	PSRR Match (Channel-to-Channel) (Note 3)	$V_S = 2.2V \text{ to } 12V,$ $V_{CM} = V_O = 0.5V$	3	82	120			80	118			dB
V_{OL}	Output Voltage Swing (Low) (Note 4)	No Load			14	30			25	75		mV
		$I_{SINK} = 1\text{mA}$			50	100	4		65	150	5, 6	mV
V_{OH}	Output Voltage Swing (High) (Note 4)	No Load			2.5	10			5	25		mV
		$I_{SINK} = 1\text{mA}$			70	150	4		100	250	5, 6	mV
I_{SC}	Short-Circuit Current	$V_S = 5V$		± 12.5	24		1	± 5	± 10		2, 3	mA
		$V_S = 3V$		± 12	19			± 5	± 9.5			mA
I_S	Supply Current per Amp				1.7	2.2	1		2	2.7	2, 3	mA

TABLE 2: ELECTRICAL CHARACTERISTICS(Preirradiation) $V_S = 3V, 5V$; $V_{CM} = V_{OUT} = \text{half supply}$, unless otherwise noted.

SYMBOL	PARAMETER	CONDITIONS	NOTES	$T_A = 25^\circ\text{C}$			SUB-GROUP	$-55^\circ\text{C} \leq T_A \leq 125^\circ\text{C}$			SUB-GROUP	UNITS
				MIN	TYP	MAX		MIN	TYP	MAX		
GBW	Gain-Bandwidth Product	$V_S = 5V, f = 100\text{kHz}$		6.8	10.5			5.8	8.5			MHz
SR	Slew Rate	$V_S = \pm 2.5V, A_V = -1,$ $R_L = 2k, V_O = \pm 2V,$ Measure at $V_O = \pm 1V$		2.6	4.5		4	2	3.6		5, 6	V/ μs

TABLE 2A: ELECTRICAL CHARACTERISTICS(Postirradiation) $V_S = 5V, 3V$; $V_{CM} = \text{half supply}$, $T_A = 25^\circ\text{C}$, unless otherwise noted.

SYMBOL	PARAMETER	CONDITIONS	NOTES	10Krad (Si)		20Krad (Si)		50Krad (Si)		100Krad (Si)		200Krad (Si)		UNITS
				MIN	MAX	MIN	MAX	MIN	MAX	MIN	MAX	MIN	MAX	
V_{OS}	Input Offset Voltage	$V_{CM} = V^+, V^-$		950		950		950		950		950		μV
I_B	Input Bias Current	$V_{CM} = V^+, V^-$		700		750		800		850		900		nA
I_{OS}	Input Offset Current	$V_{CM} = V^+, V^-$		65		65		65		65		65		nA
	Input Voltage Range			V^-	V^+	V^-	V^+	V^-	V^+	V^-	V^+	V^-	V^+	V
A_{VOL}	Large-Signal Voltage Gain	$V_O = 75\text{mV to } V^+ - 0.2V$ $R_1 = 10k$		300		300		300		300		300		V/mV
CMRR	Common Mode Rejection Ratio	$V_{CM} = V^+ \text{ to } V^-$		70		70		70		70		70		dB
	CMRR Match (Channel-to-Channel)	$V_{CM} = V^+ \text{ to } V^-$	3	70		70		70		70		70		dB
PSRR	Power Supply Rejection Ratio	$V_S = 2.2V \text{ to } 12V,$ $V_{CM} = V_O = 0.5V$		88		88		88		88		88		dB
	PSRR Match (Channel-to-Channel)	$V_S = 2.2V \text{ to } 12V,$ $V_{CM} = V_O = 0.5V$	3	82		82		82		82		82		dB
V_{OUT}	Output Voltage Swing Low	No Load $I_{SINK} = 1\text{mA}$ $I_{SINK} = 2.5\text{mA}$	4	60	100	200	60	100	200	60	100	200	60	mV mV mV
	Output Voltage Swing High	No Load $I_{SINK} = 1\text{mA}$ $I_{SINK} = 2.5\text{mA}$	4	20	150	250	20	150	250	20	150	250	20	mV mV mV
I_{SC}	Short-Circuit Current			± 8		± 8		± 8		± 8		± 8		mA
I_S	Supply Current			2.2		2.2		2.2		2.2		2.2		mA
SR	Slew Rate	$V_S = \pm 2.5V, A_V = -1,$ $R_L = 10k, V_O = \pm 2V,$ Measure at $V_O = \pm 1V$		2		2		2		2		2		V/ μs

Note 1: Stresses beyond those listed under Absolute Maximum Ratings may cause permanent damage to the device. Exposure to any Absolute Maximum Rating condition for extended periods may affect device reliability and lifetime.

Note 2: A heat sink may be required to keep the junction temperature below this absolute maximum rating when the output is shorted indefinitely.

Note 3: Matching parameters are the difference between amplifiers A and D and between B and C.

Note 4: Output voltage swings are measured between the output and power supply rails.

TABLE 2: ELECTRICAL TEST REQUIREMENTS

MIL-STD-883 TEST REQUIREMENTS	SUBGROUP
Final Electrical Test Requirements (Method 5004)	1*,2,3,4,5,6
Group A Test Requirements (Method 5005)	1,2,3,4,5,6
Group B and D for Class S, and End Point Electrical Parameters (Method 5005)	1,2,3

*PDA applies to subgroup 1. See PDA Test Notes.

PDA Test Notes

The PDA is specified as 5% based on failures from group A, subgroup 1, tests after cooldown as the final electrical test in accordance with method 5004 of MIL-STD-883. The verified failures of group A, subgroup 1, after burn-in divided by the total number of devices submitted for burn-in in that lot shall be used to determine the percent for the lot.

Linear Technology Corporation reserves the right to test to tighter limits than those given.

TOTAL DOSE BIAS CIRCUIT

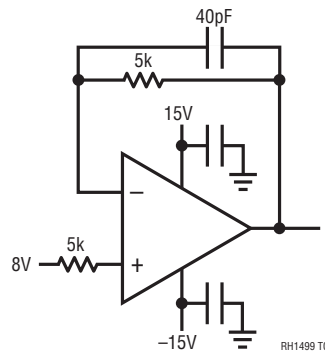

TYPICAL PERFORMANCE CHARACTERISTICS

Large Signal Voltage Gain

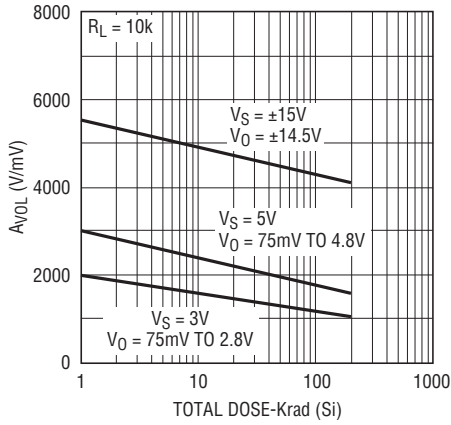

Large Signal Voltage Gain

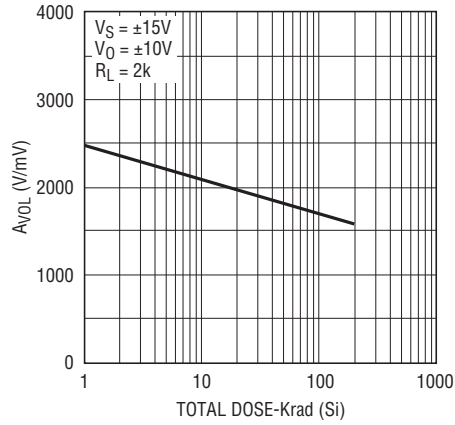

Slew Rate

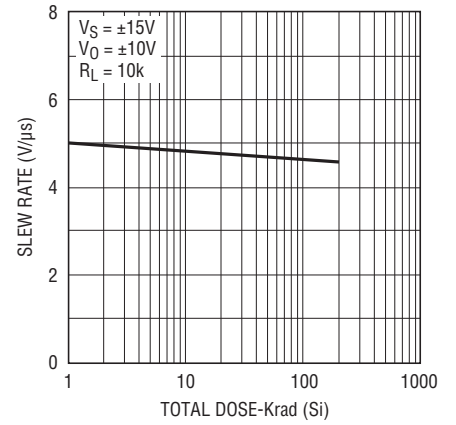

Supply Current per Amp

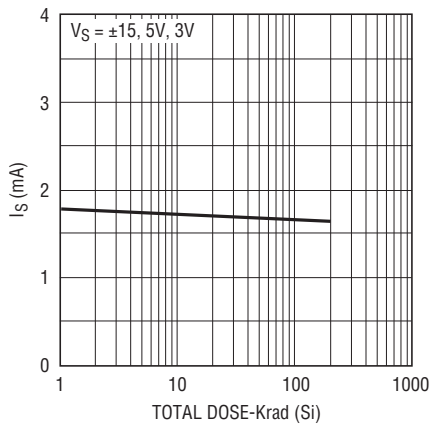

Input Offset Voltage

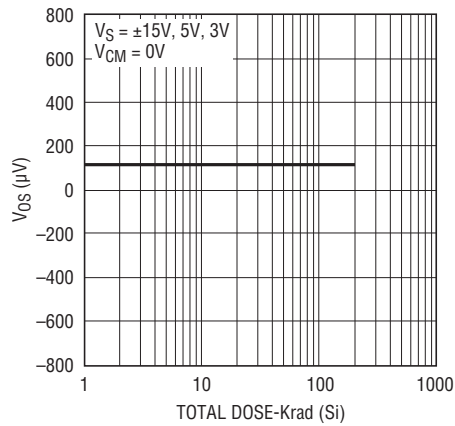

Input Offset Current

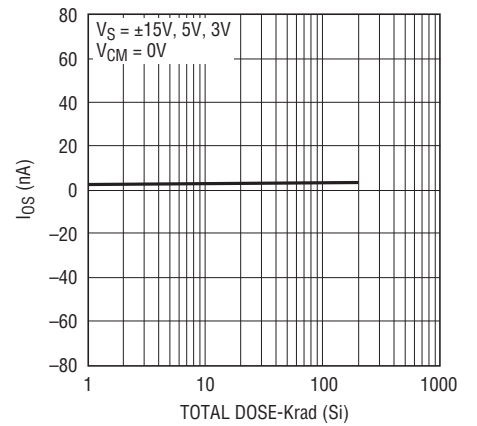

Input Bias Current

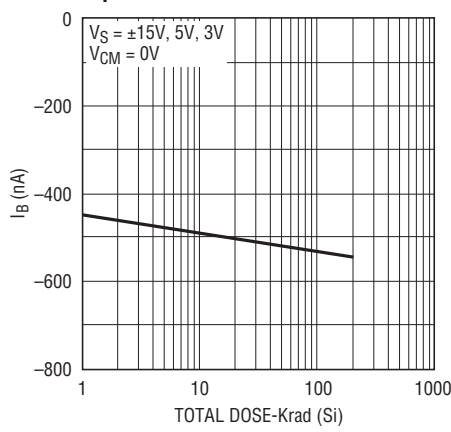

Common Mode Rejection Ratio

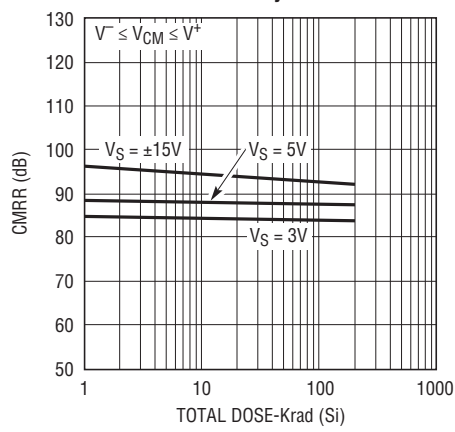

Power Supply Rejection Ratio

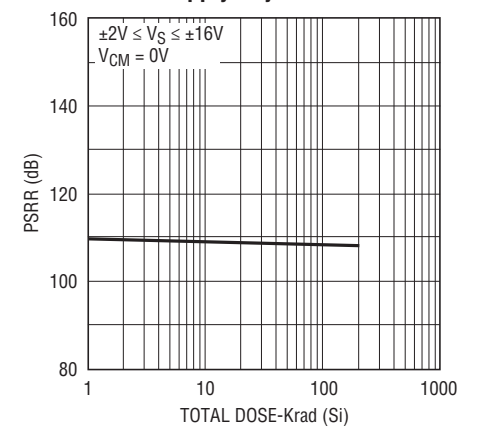

TYPICAL PERFORMANCE CHARACTERISTICS

Supply Current vs Supply Voltage

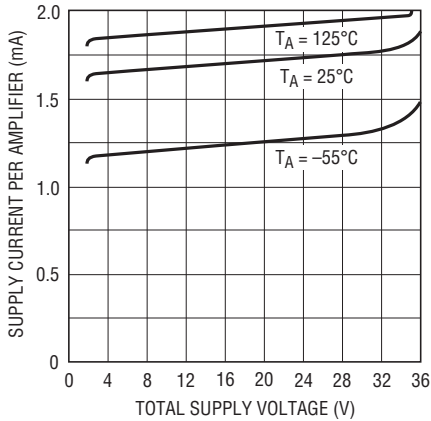

RH1499 G10

Supply Current vs Temperature

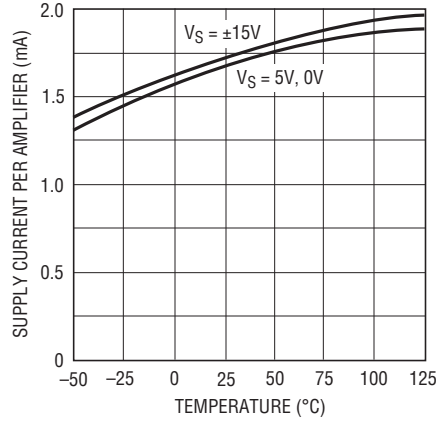

RH1499 G11

Input Bias Current vs Common Mode Voltage

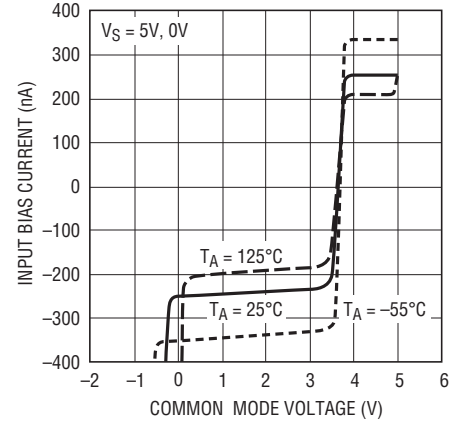

RH1499 G12

Open-Loop Voltage Gain vs Temperature

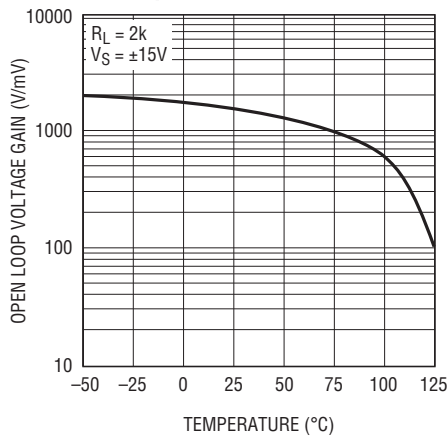

RH1499 G13

Input Bias Current vs Temperature

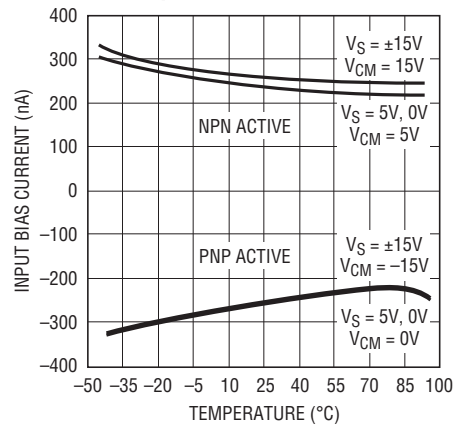

RH1499 G14

Output Saturation Voltage vs Load Current (Output High)

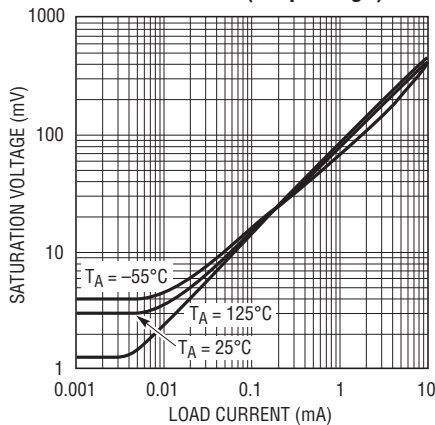

RH1499 G15

Output Saturation Voltage vs Load Current (Output Low)

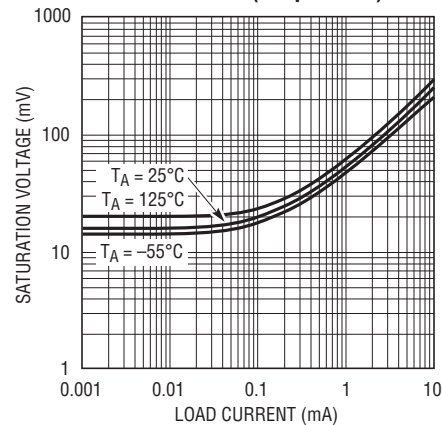

RH1499 G16