

# FMS6303

## Low-Cost, 3-Channel, Video Filter Driver for SD/ED/HD (1080i)/HD (1080P)

### Features

- Three 6th-Order Video Anti-Aliasing or Reconstruction Filters
- Supports Component YPrPb or RGB Video
- Three Channels: Selectable to 8MHz, 16MHz, 32MHz, or 65MHz for SD/ED/HD\_1080i, HD\_1080p Applications
- Single Video Load Driver ( $2V_{PP}$ ,  $150\Omega$ ,  $A_V = 6dB$ )
- Selectable Clamp or Bias Mode on Pb/B, Pr/R Inputs
- AC- or DC-Coupled Inputs and Outputs
- DC-Coupled Outputs Eliminate Coupling Capacitors
- Output Disable
- Single 5V Supply
- 2kV CDM / 9kV HBM ESD Protection

### Applications

- Cable and Satellite Set-Top Boxes
- DVD Players
- HDTV
- Personal Video Recorders (PVR)
- Video On Demand (VOD)

### Description

FMS6303 offers comprehensive filtering for set-top box or DVD applications. It is intended to replace passive LC filters and drivers with a low-cost integrated device.

Filter channels are specialized for either component (YPbPr) or RGB video signals. These channels offer a selectable frequency response of 8, 16, 32, or 65MHz. Additional functionality of these channels includes input biasing mode and output disable.

The FMS6303 may be driven directly by a DC-coupled DAC output or an AC-coupled signal. All inputs accept standard  $1V_{pp}$  video signals.

Each channel includes an output amplifier capable of driving a single ( $150\Omega$ ) AC- or DC-coupled video load. All outputs can be disabled to save power in DC-coupled applications.

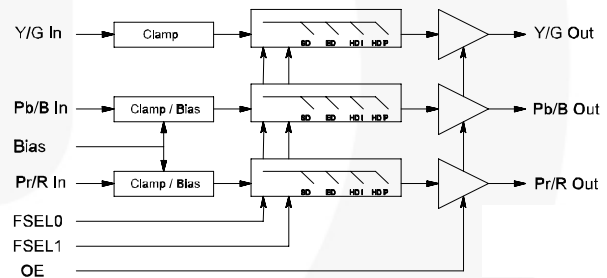

Figure 1. Block Diagram

### Ordering Information

Part Number	Operating Temperature Range	Gain Setting	Eco Status	Package	Packing Method
FMS6303MTC1406X	-40°C to +85°C	6dB	RoHS	TSSOP-14	Tape and Reel

For Fairchild's definition of Eco Status, please visit: [http://www.fairchildsemi.com/company/green/rohs\\_green.html](http://www.fairchildsemi.com/company/green/rohs_green.html).

#### Note:

1. Moisture sensitivity level for all parts is MSL-1.

## Pin Configuration

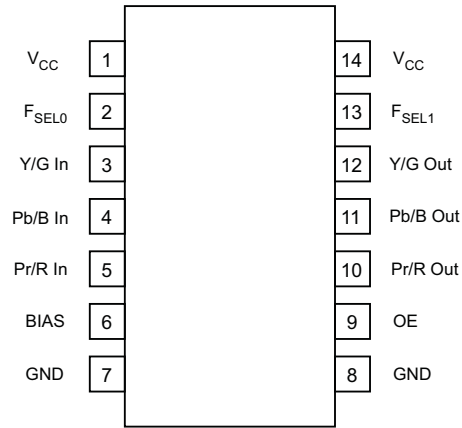

Figure 2. Pin Configuration

## Pin Definitions

Pin #	Name	Type	Description
1	V <sub>CC</sub>	Input	+5V supply
2	F <sub>SEL0</sub>	Input	Selects filter corner frequency
3	Y/G In	Input	Selectable video input
4	Pb/B In	Input	Selectable video input
5	Pr/R In	Input	Selectable video input
6	BIAS	Input	Input Bias on Pb/B Pr/R 0=Bias 1=Clamp
7	GND	Input	Must be tied to ground. Do not float.
8	GND	Input	Must be tied to ground. Do not float.
9	OE	Input	Output disable control: 0=OFF, 1=ON
10	Pr/R Out	Output	Filtered SD, ED, HD I, HD P video output
11	Pb/B Out	Output	Filtered SD, ED, HD I, HD P video output
12	Y/G Out	Output	Filtered SD, ED, HD I, HD P video output
13	F <sub>SEL1</sub>	Input	Selects filter corner frequency
14	V <sub>CC</sub>	Input	+5V supply

## Frequency Select Truth Table

F <sub>SEL1</sub>	F <sub>SEL0</sub>	Filter Frequency	Video Format	Sync Format
0	0	8MHz	SD, 480i	Bi-level, 4.70μs Pulsewidth
0	1	16MHz	ED, 480p	Bi-level, 2.35μs Pulsewidth
1	0	32MHz	HD, 1080i, 720p	Tri-level, 589ns Pulsewidth
1	1	75MHz	HD, 1080p	Tri-level, 295ns Pulsewidth

## Absolute Maximum Ratings

Stresses exceeding the absolute maximum ratings may damage the device. The device may not function or be operable above the recommended operating conditions and stressing the parts to these levels is not recommended. In addition, extended exposure to stresses above the recommended operating conditions may affect device reliability. The absolute maximum ratings are stress ratings only.

Symbol	Parameter	Min.	Max.	Unit
V <sub>CC</sub>	DC Supply Voltage	-0.3	6.0	V
V <sub>IO</sub>	Analog and Digital I/O	-0.3	V <sub>CC</sub> +0.3	V
I <sub>OUT</sub>	Output Current, Any One Channel, Do Not Exceed		50	mA

## Reliability Information

Symbol	Parameter	Min.	Typ.	Max.	Unit
T <sub>J</sub>	Junction Temperature			+150	°C
T <sub>STG</sub>	Storage Temperature Range	-65		+150	°C
T <sub>L</sub>	Reflow Temperature, Soldering 10 Seconds			+260	°C
θ <sub>JA</sub>	Thermal Resistance, JEDEC Standard Multi-Layer Test Boards, Still Air		97		°C/W

## Electrostatic Discharge Information

Symbol	Parameter	Max.	Unit
ESD	Human Body Model, JESD22-A114	9	kV
	Charged Device Model, JESD22-C101	2	

## Recommended Operating Conditions

The Recommended Operating Conditions table defines the conditions for actual device operation. Recommended operating conditions are specified to ensure optimal performance to the datasheet specifications. Fairchild does not recommend exceeding them or designing to Absolute Maximum Ratings.

Symbol	Parameter	Min.	Typ.	Max.	Unit
T <sub>A</sub>	Operating Temperature Range	-40		+85	°C
V <sub>CC</sub>	Supply Voltage Range	4.75	5.00	5.25	V

## Electrical Characteristics

Unless otherwise noted, T<sub>A</sub>=25°C, V<sub>CC</sub>=5V, R<sub>SOURCE</sub>=37.5Ω, inputs AC coupled with 0.1μF, all outputs AC coupled with 220μF into 150Ω loads, referenced to 400kHz.

Symbol	Parameter	Conditions	Min.	Typ.	Max.	Units
A <sub>v</sub>	Channel Gain <sup>(2)</sup>	DC	5.8	6.0	6.2	dB
I <sub>CC</sub>	Supply Current <sup>(2)</sup>	No Load, SD, ED, HD 1080i		36		mA
		No Load, HD 1080p		60	80	
I <sub>CC_SD</sub>	Shutdown Supply Current <sup>(2)</sup>	No Load, Output Disabled		20	40	mA
PSRR	Power Supply Rejection	DC (All Channels)		70		dB
V <sub>IN</sub>	Video Input Voltage Range	Referenced to GND if DC Coupled		1.0		V <sub>PP</sub>
V <sub>IL</sub>	Digital Input Low <sup>(2)</sup>	F <sub>SELO</sub> , F <sub>SEL1</sub>	0		0.8	V
V <sub>IH</sub>	Digital Input High <sup>(2)</sup>	F <sub>SELO</sub> , F <sub>SEL1</sub>	2.4		V <sub>CC</sub>	V
t <sub>ENABLE</sub>	Output Enable Time	150Ω DC Load		10		μs

### Note:

- 100% tested at 25°C.

### Standard Definition (480i) Electrical Characteristics

Unless otherwise noted,  $T_A=25^\circ\text{C}$ ,  $V_{CC}=5\text{V}$ ,  $R_{SOURCE}=37.5\Omega$ , all inputs AC coupled with  $0.1\mu\text{F}$ , all outputs AC coupled with  $220\mu\text{F}$  into  $150\Omega$  loads, referenced to  $400\text{kHz}$ .

Symbol	Parameter	Conditions	Min.	Typ.	Max.	Units
$AV_{SD}$	Channel Gain Error <sup>(3)</sup>	DC	-0.2	0	0.2	dB
$f_{1dBSD}$	-1dB Bandwidth <sup>(3)</sup>		5.2	7.0		MHz
$f_{cSD}$	-3dB Bandwidth <sup>(3)</sup>		6.5	8.0		MHz
$f_{SBSD}$	Attenuation (Stopband Reject) <sup>(3)</sup>	$f=27\text{MHz}$	45	50		dB
DG	Differential Gain			0.1		%
DP	Differential Phase			0.8		°
THD	Total Harmonic Distortion, Output	$V_{OUT}=1.4V_{PP}$ , 3.58MHz		0.25		%
$X_{TALKSD}$	Crosstalk (ch-to-ch)	1MHz		-78		dB
SNR	Signal-to-Noise Ratio <sup>(4)</sup>	NTC-7 Weighting, 100kHz to 4.2MHz		74		dB
$t_{pdSD}$	Propagation Delay	Delay from Input to Output, 4.5MHz		65		ns

**Notes:**

- 100% tested at  $25^\circ\text{C}$ .
- SNR=20 • log (714mV / rms noise).

### Enhanced Definition (480p) Electrical Characteristics

Unless otherwise noted,  $T_A=25^\circ\text{C}$ ,  $V_{CC}=5\text{V}$ ,  $R_{SOURCE}=37.5\Omega$ , inputs AC coupled with  $0.1\mu\text{F}$ , all outputs AC coupled with  $220\mu\text{F}$  into  $150\Omega$  loads, referenced to  $400\text{kHz}$ .

Symbol	Parameter	Conditions	Min.	Typ.	Max.	Units
$AV_{ED}$	Channel Gain Error <sup>(5)</sup>	DC	-0.2	0	0.2	dB
$f_{1dBSED}$	-1dB Bandwidth <sup>(5)</sup>		10	14		MHz
$f_{cED}$	-3dB Bandwidth <sup>(5)</sup>		13	16		MHz
$f_{SBED}$	Attenuation (Stopband Reject) <sup>(5)</sup>	$f=54\text{MHz}$	37	50		dB
THD	Total Harmonic Distortion, Output	$V_{OUT}=1.4V_{PP}$ , 7MHz		0.1		%
$X_{TALKED}$	Crosstalk (ch-to-ch)	1MHz		-70		dB
SNR	Signal-to-Noise Ratio <sup>(6)</sup>	Unweighted; 100kHz to 15MHz		66		dB
$t_{pdED}$	Propagation Delay	Delay from Input to Output, 10MHz		30		ns

**Notes:**

- 100% tested at  $25^\circ\text{C}$ .
- SNR=20 • log (714mV / rms noise).

## High-Definition (1080i) Electrical Characteristic

Unless otherwise noted,  $T_A=25^\circ\text{C}$ ,  $V_{CC}=5\text{V}$ ,  $R_{SOURCE}=37.5\Omega$ , inputs AC coupled with  $0.1\mu\text{F}$ , all outputs AC coupled with  $220\mu\text{F}$  into  $150\Omega$  loads, referenced to  $400\text{kHz}$ .

Symbol	Parameter	Conditions	Min.	Typ.	Max.	Units
$AV_{HD}$	Channel Gain Error <sup>(7)</sup>	DC	-0.2	0	0.2	dB
$f_{1dBHD}$	-1dB Bandwidth <sup>(7)</sup>		28	30		MHz
$f_{cHD}$	-3dB Bandwidth <sup>(7)</sup>		30	32		MHz
$f_{SBHD}$	Attenuation (Stopband Reject) <sup>(7)</sup>	$f=74.25\text{MHz}$	30	40		dB
THD	Total Harmonic Distortion, Output	$V_{OUT}=1.4V_{PP}$ , 22MHz, 6dB, $150\Omega$ Load		0.5		%
$X_{TALKHD}$	Crosstalk (ch-to-ch)	1MHz		-72		dB
		30MHz		-63		dB
SNR	Signal-to-Noise Ratio <sup>(8)</sup>	Unweighted, 100kHz to 30MHz		66		dB
$t_{pdHD}$	Propagation Delay	Delay from Input to Output, 20MHz		17		ns

### Notes:

7. 100% tested at  $25^\circ\text{C}$ .
8.  $SNR=20 \cdot \log(714\text{mV} / \text{rms noise})$ .

## High-Definition (1080p) Electrical Characteristics

Unless otherwise noted,  $T_A=25^\circ\text{C}$ ,  $V_{CC}=5\text{V}$ ,  $R_{SOURCE}=37.5\Omega$ , inputs AC coupled with  $0.1\mu\text{F}$ , all outputs AC coupled with  $220\mu\text{F}$  into  $150\Omega$  loads, referenced to  $400\text{kHz}$ .

Symbol	Parameter	Conditions	Min.	Typ.	Max.	Units
$AV_{HD}$	Channel Gain Error <sup>(9)</sup>	DC	-0.2	0	0.2	dB
$f_{1dBHD}$	-1dB Bandwidth <sup>(9)</sup>		50	55		MHz
$f_{cHD}$	-3dB Bandwidth <sup>(9)</sup>		60	65		MHz
$f_{sbHD}$	Attenuation (Stopband Reject) <sup>(9)</sup>	$f=148\text{MHz}$	15	23		dB
THD	Total Harmonic Distortion, Output	$V_{OUT}=1.4V_{PP}$ , 44MHz, 6dB, $150\Omega$ Load		0.5		%
$X_{TALKHD}$	Crosstalk (ch-to-ch)	1MHz		-78		dB
		60MHz		-62		dB
SNR	Signal-to-Noise Ratio <sup>(10)</sup>	Unweighted, 100kHz to 60MHz		69		dB
$t_{pdHD}$	Propagation Delay	Delay from Input to Output, 20MHz		8		ns

### Notes:

9. 100% tested at  $25^\circ\text{C}$ .
10.  $SNR=20 \cdot \log(714\text{mV} / \text{rms noise})$ .

Typical Performance Characteristics

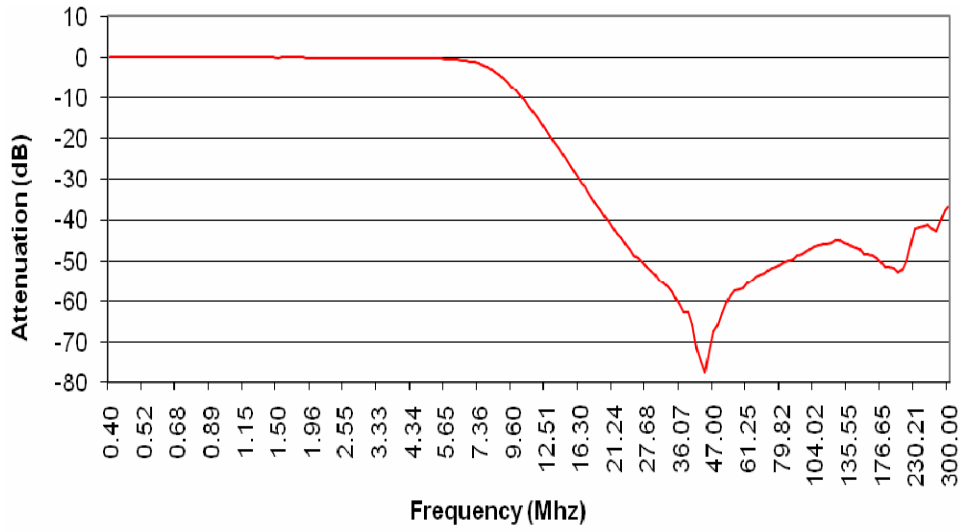

Figure 3. FMS6303 SD Frequency Response

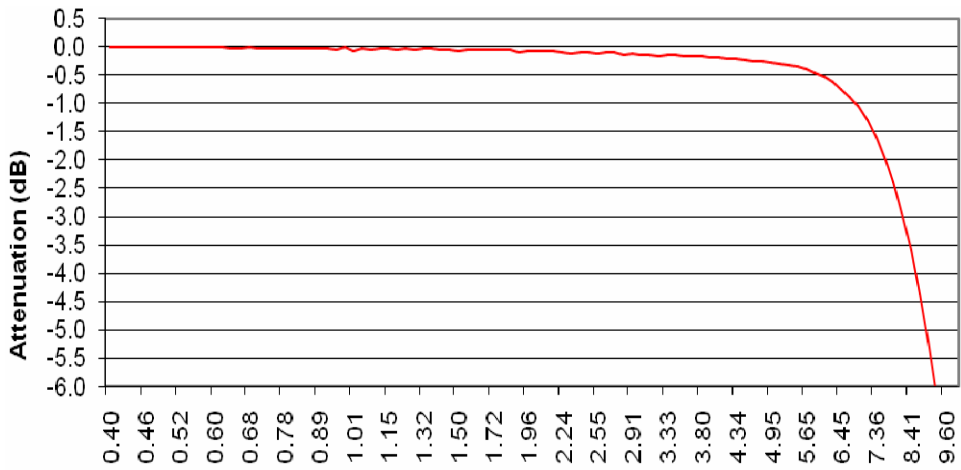

Figure 4. FMS6303 SD Frequency Response (Flatness)

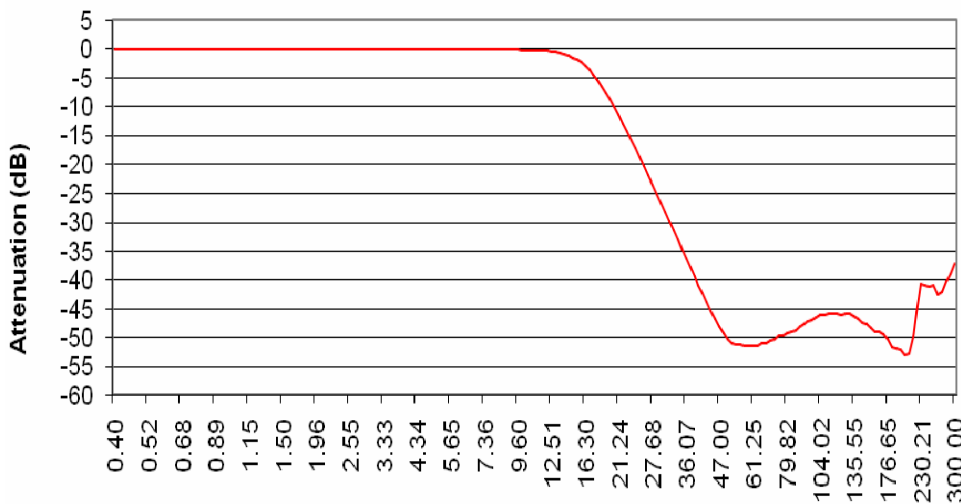

Figure 5. FMS6303 ED Frequency Response

### Typical Performance Characteristics

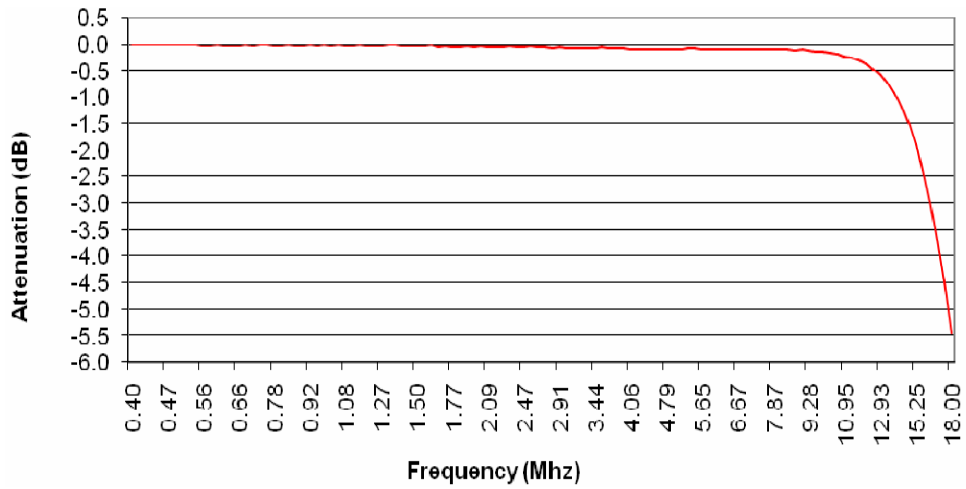

Figure 6. FMS6303 ED Frequency Response (Flatness)

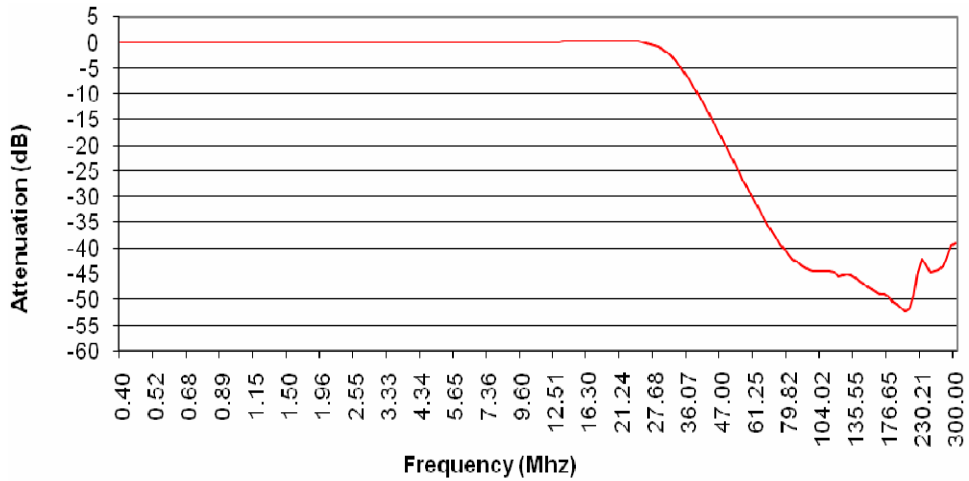

Figure 7. FMS6303 1080i HD Frequency Response

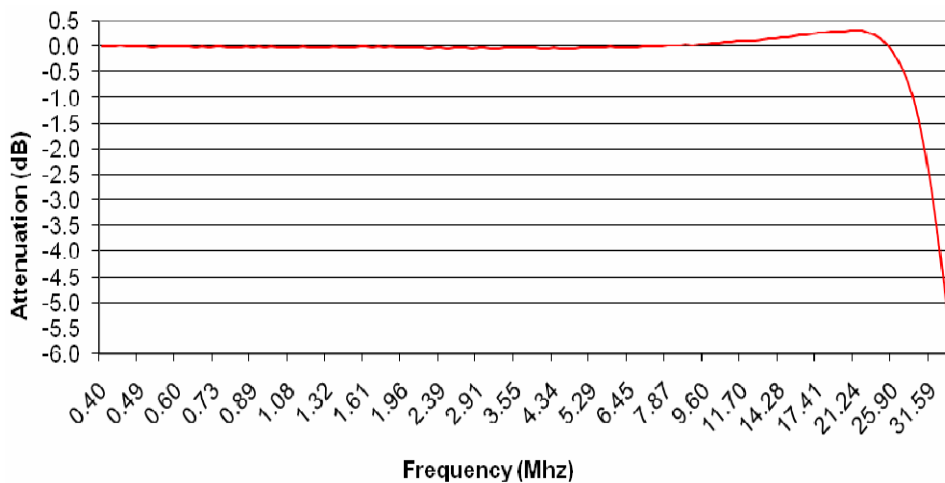

Figure 8. FMS6303 1080i HD Frequency Response (Flatness)

### Typical Performance Characteristics

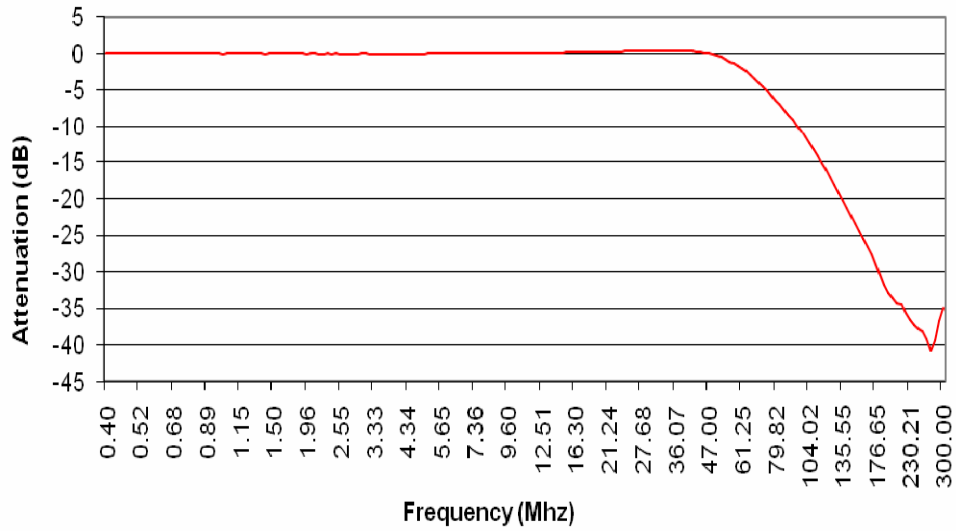

Figure 9. FMS6303 1080p Frequency Response

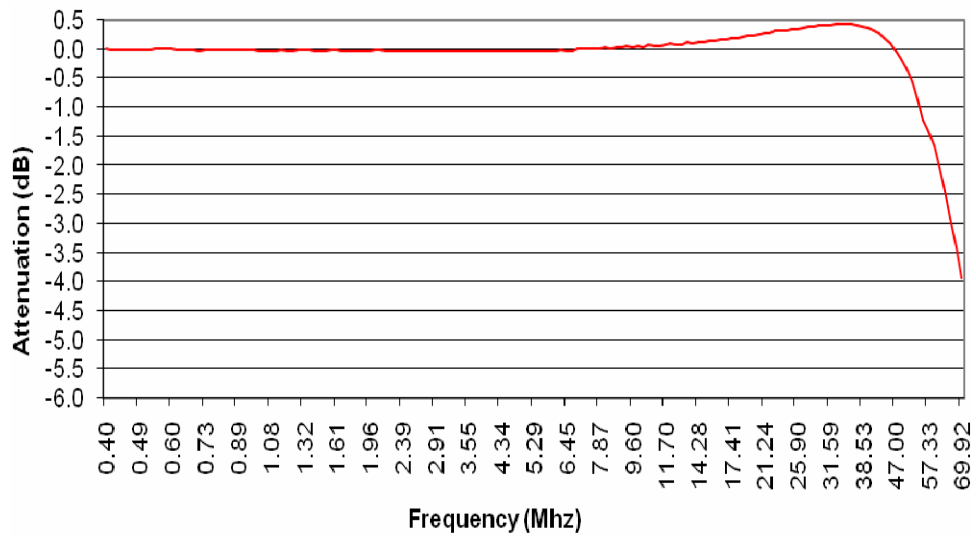
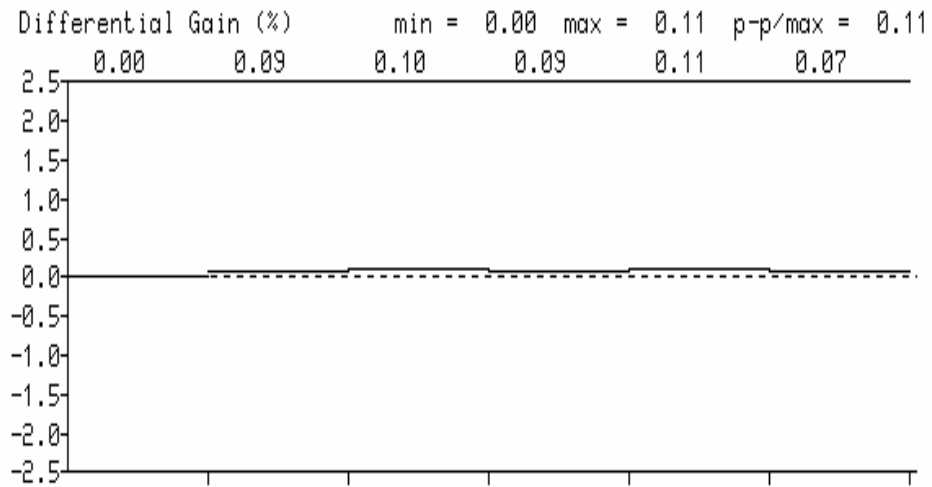

Figure 10. FMS6303 1080p Frequency Response (Flatness)



**Typical Performance Characteristics**



**Figure 11. Differential Gain**

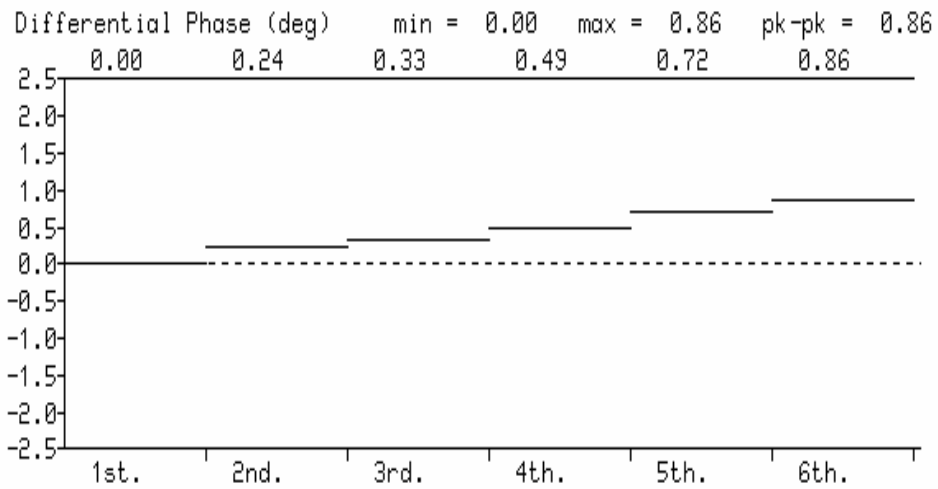

**Figure 12. Differential Phase**

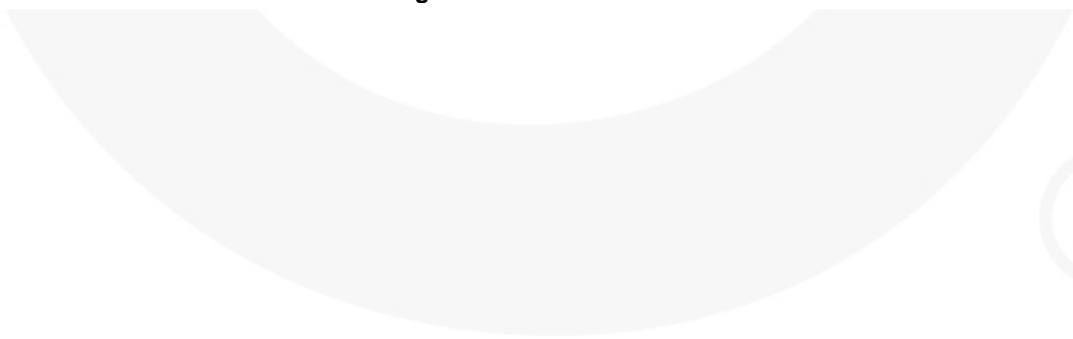

## Layout Considerations

General layout and supply bypassing play a major role in high-frequency performance and thermal characteristics. Fairchild offers an evaluation board to guide layout and aid device evaluation. The evaluation board is a four-layer board with full power and ground planes. Following this layout configuration provides optimum performance and thermal characteristics for the device. For the best results, follow the steps and recommended routing rules listed below.

### Recommended Routing / Layout Rules

- Do not run analog and digital signals in parallel.
- Use separate analog and digital power planes to supply power.
- Run traces on top of the ground plane at all times.
- Do not run traces over ground/power splits.
- Avoid routing at 90-degree angles.
- Minimize clock and video data trace length differences.
- Include 10 $\mu$ F and 0.1 $\mu$ F ceramic power supply bypass capacitors.
- Place the 0.1 $\mu$ F capacitor within 0.1 inches of the device power pin.
- Place the 10 $\mu$ F capacitor within 0.75 inches of the device power pin.
- For multi-layer boards, use a large ground plane to help dissipate heat.
- For two-layer boards, use a ground plane that extends beyond the device body by at least 0.5 inches on all sides. Include a metal paddle under the device on the top layer.
- Minimize all trace lengths to reduce series inductance.

### Thermal Considerations

Since the interior of most systems, such as set-top boxes, TVs, and DVD players, are at +70°C; consideration must be given to providing an adequate heat sink for the device package for maximum heat dissipation. When designing a system board, determine how much power each device dissipates. Ensure that devices of high power are not placed in the same location, such as directly above (top plane) and below (bottom plane) each other on the PCB.

### PCB Thermal Layout Considerations

- Understand the system power requirements and environmental conditions.
- Maximize thermal performance of the PCB.

- Consider 70 $\mu$ m copper for high-power designs.
- Make the PCB as thin as possible by reducing FR4 thickness.
- Use vias in the power pad to tie adjacent layers together.
- Remember that baseline temperature is a function of board area, not copper thickness.
- Use modeling techniques for first-order approximation.

### Output Considerations

The FMS6303 outputs are DC offset from the input by 150mV; therefore,  $V_{OUT} = 2 \cdot V_{IN} DC + 150mV$ . This offset is required to obtain optimal performance from the output driver and is held at the minimum value to decrease the standing DC current into the load. Since the FMS6303 has a 2x (6dB) gain, the output is typically connected via a 75 $\Omega$ -series back-matching resistor followed by the 75 $\Omega$  video cable. Because of the inherent divide by two of this configuration, the blanking level at the load of the video signal is always less than 1V. When AC-coupling the output, ensure that the coupling capacitor of choice passes the lowest frequency content in the video signal and that line time distortion (video tilt) is kept as low as possible.

The selection of the coupling capacitor is a function of the subsequent circuit input impedance and the leakage current of the input being driven. To obtain the highest quality output video signal, the series termination resistor must be placed as close to the device output pin as possible. This greatly reduces the parasitic capacitance and inductance effect on the FMS6303 output driver. Recommended distance from device pin to place series termination resistor is no greater than 0.1 inches.

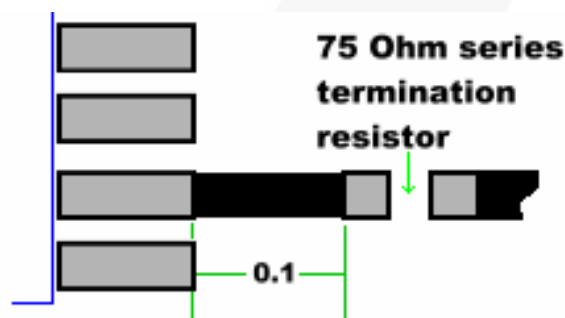
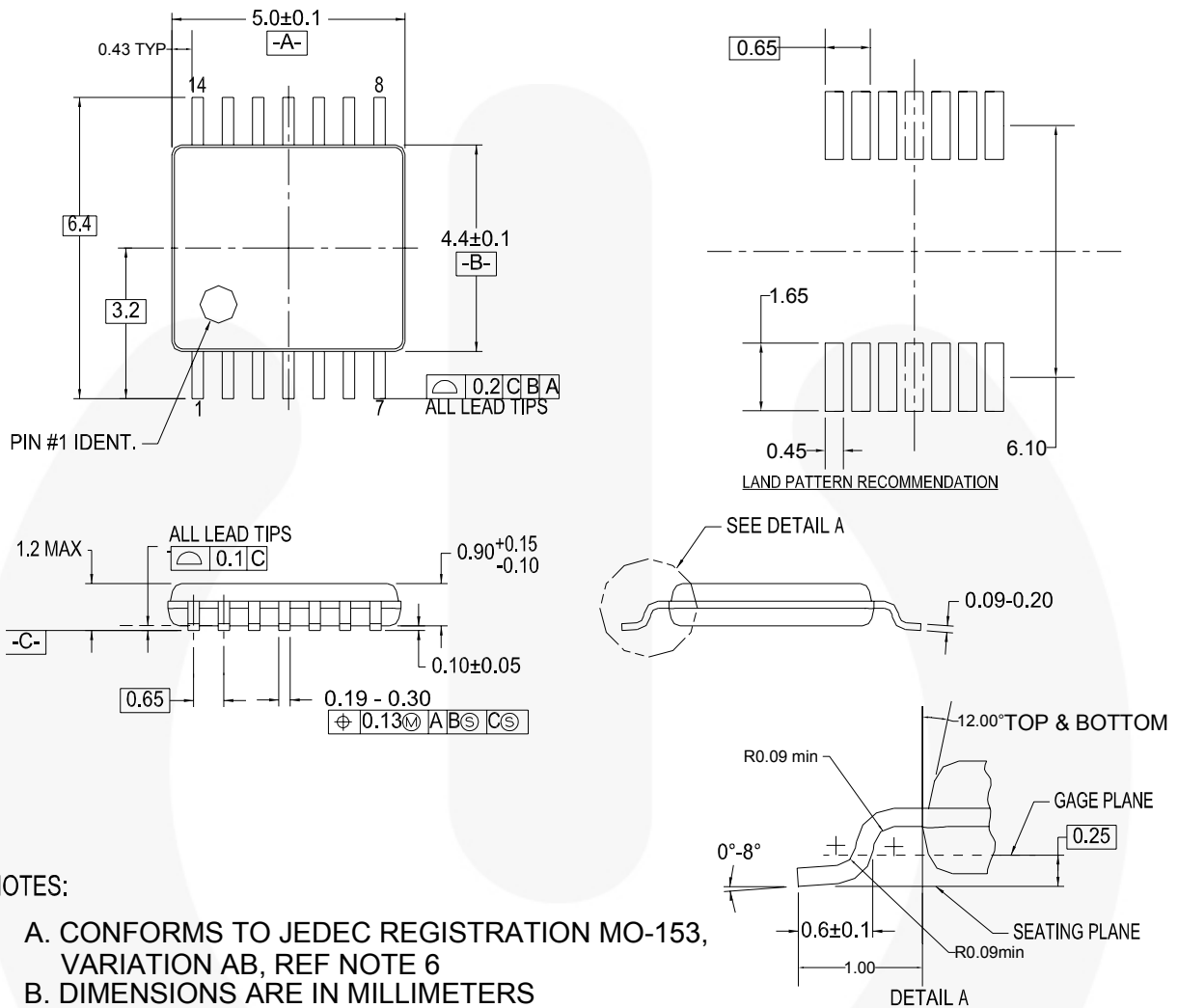

Figure 13. Distance from Device Pin to Series Termination Resistor

## Physical Dimensions



### NOTES:

- A. CONFORMS TO JEDEC REGISTRATION MO-153, VARIATION AB, REF NOTE 6
- B. DIMENSIONS ARE IN MILLIMETERS
- C. DIMENSIONS ARE EXCLUSIVE OF BURRS, MOLD FLASH, AND TIE BAR EXTRUSIONS
- D. DIMENSIONING AND TOLERANCES PER ANSI Y14.5M, 1982
- E. LANDPATTERN STANDARD: SOP65P640X110-14M
- F. DRAWING FILE NAME: MTC14REV6

**Figure 14. 14-Lead Thin Shrink Small Outline Package (TSSOP)**

Package drawings are provided as a service to customers considering Fairchild components. Drawings may change in any manner without notice. Please note the revision and/or date on the drawing and contact a Fairchild Semiconductor representative to verify or obtain the most recent revision. Package specifications do not expand the terms of Fairchild's worldwide terms and conditions, specifically the warranty therein, which covers Fairchild products.

Always visit Fairchild Semiconductor's online packaging area for the most recent package drawings:  
<http://www.fairchildsemi.com/packaging/>



**TRADEMARKS**

The following includes registered and unregistered trademarks and service marks, owned by Fairchild Semiconductor and/or its global subsidiaries, and is not intended to be an exhaustive list of all such trademarks.

AccuPower™  
Auto-SPM™  
Build it Now™  
CorePLUS™  
CorePOWER™  
CROSSVOLT™  
CTL™  
Current Transfer Logic™  
EcoSPARK®  
EfficientMax™  
EZSWITCH™  
EZ™  
F®  
Fairchild®  
Fairchild Semiconductor®  
FACT Quiet Series™  
FACT®  
FAST®  
FastvCore™  
FETBench™  
FlashWriter®

FPS™  
F-PFS™  
FRFET®  
Global Power Resource™  
Green FPS™  
Green FPS™ e-Series™  
Gmax™  
GTO™  
IntelliMAX™  
ISOPLANAR™  
MegaBuck™  
MICROCOUPLER™  
MicroFET™  
MicroPak™  
MillerDrive™  
MotionMax™  
Motion-SPM™  
OPTOLOGIC®  
OPTOPLANAR®  
PDP-SPM™  
Power-SPM™

PowerTrench®  
PowerXS™  
Programmable Active Droop™  
QFET®  
QST™  
Quiet Series™  
RapidConfigure™  
Saving our world, 1mW/W/kW at a time™  
SignalWise™  
SmartMax™  
SMART START™  
SPM®  
STEALTH™  
SuperFET™  
SuperSOT™.3  
SuperSOT™.6  
SuperSOT™.8  
SupreMOS™  
SyncFET™  
Sync-Lock™  
SYSTEM GENERAL®

The Power Franchise®  
the power franchise  
TinyBoost™  
TinyBuck™  
TinyCalc™  
TinyLogic™  
TINYOPTO™  
TinyPower™  
TinyPWM™  
TinyWire™  
TriFault Detect™  
TRUECURRENT™  
µSerDes™  
SerDes™  
UHC®  
Ultra FRFET™  
UniFET™  
VCX™  
VisualMax™  
XS™

\* Trademarks of System General Corporation, used under license by Fairchild Semiconductor.

**DISCLAIMER**

FAIRCHILD SEMICONDUCTOR RESERVES THE RIGHT TO MAKE CHANGES WITHOUT FURTHER NOTICE TO ANY PRODUCTS HEREIN TO IMPROVE RELIABILITY, FUNCTION, OR DESIGN. FAIRCHILD DOES NOT ASSUME ANY LIABILITY ARISING OUT OF THE APPLICATION OR USE OF ANY PRODUCT OR CIRCUIT DESCRIBED HEREIN; NEITHER DOES IT CONVEY ANY LICENSE UNDER ITS PATENT RIGHTS, NOR THE RIGHTS OF OTHERS. THESE SPECIFICATIONS DO NOT EXPAND THE TERMS OF FAIRCHILD'S WORLDWIDE TERMS AND CONDITIONS, SPECIFICALLY THE WARRANTY THEREIN, WHICH COVERS THESE PRODUCTS.

**LIFE SUPPORT POLICY**

FAIRCHILD'S PRODUCTS ARE NOT AUTHORIZED FOR USE AS CRITICAL COMPONENTS IN LIFE SUPPORT DEVICES OR SYSTEMS WITHOUT THE EXPRESS WRITTEN APPROVAL OF FAIRCHILD SEMICONDUCTOR CORPORATION.

As used herein:

1. Life support devices or systems are devices or systems which, (a) are intended for surgical implant into the body or (b) support or sustain life, and (c) whose failure to perform when properly used in accordance with instructions for use provided in the labeling, can be reasonably expected to result in a significant injury of the user.
2. A critical component in any component of a life support, device, or system whose failure to perform can be reasonably expected to cause the failure of the life support device or system, or to affect its safety or effectiveness.

**ANTI-COUNTERFEITING POLICY**

Fairchild Semiconductor Corporation's Anti-Counterfeiting Policy. Fairchild's Anti-Counterfeiting Policy is also stated on our external website, [www.fairchildsemi.com](http://www.fairchildsemi.com), under Sales Support.

Counterfeiting of semiconductor parts is a growing problem in the industry. All manufacturers of semiconductor products are experiencing counterfeiting of their parts. Customers who inadvertently purchase counterfeit parts experience many problems such as loss of brand reputation, substandard performance, failed applications, and increased cost of production and manufacturing delays. Fairchild is taking strong measures to protect ourselves and our customers from the proliferation of counterfeit parts. Fairchild strongly encourages customers to purchase Fairchild parts either directly from Fairchild or from Authorized Fairchild Distributors who are listed by country on our web page cited above. Products customers buy either from Fairchild directly or from Authorized Fairchild Distributors are genuine parts, have full traceability, meet Fairchild's quality standards for handling and storage and provide access to Fairchild's full range of up-to-date technical and product information. Fairchild and our Authorized Distributors will stand behind all warranties and will appropriately address any warranty issues that may arise. Fairchild will not provide any warranty coverage or other assistance for parts bought from Unauthorized Sources. Fairchild is committed to combat this global problem and encourage our customers to do their part in stopping this practice by buying direct or from authorized distributors.

**PRODUCT STATUS DEFINITIONS**

**Definition of Terms**

Datasheet Identification	Product Status	Definition
Advance Information	Formative / In Design	Datasheet contains the design specifications for product development. Specifications may change in any manner without notice.
Preliminary	First Production	Datasheet contains preliminary data; supplementary data will be published at a later date. Fairchild Semiconductor reserves the right to make changes at any time without notice to improve design.
No Identification Needed	Full Production	Datasheet contains final specifications. Fairchild Semiconductor reserves the right to make changes at any time without notice to improve the design.
Obsolete	Not In Production	Datasheet contains specifications on a product that is discontinued by Fairchild Semiconductor. The datasheet is for reference information only.

Rev. 142