

Rack and Panel Connectors Subminiature Rectangular

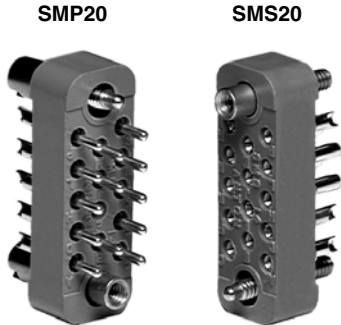

FEATURES

- Lightweight.
- Polarized by guides or screwlocks.
- Screwlocks lock connectors together to withstand vibration and accidental disconnect.
- Overall height kept to a minimum.
- Floating contacts aid in alignment and in withstanding vibration.
- Contacts, precision machined and individually gauged, provide high reliability.
- Insertion and withdrawal forces kept low without increasing contact resistance.
- Contact plating provides protection against corrosion, assures low contact resistance and ease of soldering.

APPLICATIONS

For use wherever space is at a premium and a high quality connector is required in avionics, automation, communications, controls, instrumentation, missiles, computers and guidance systems.

ELECTRICAL SPECIFICATIONS

Current Rating: 7.5 amps.
Breakdown Voltage:
 At sea level: 2000 V RMS.
 At 70,000 feet [21,336 meters]: 500 V RMS.

PHYSICAL SPECIFICATIONS

Number of Contacts: 5, 7, 11, 14, 20, 26, 34, 42, 50, 75.
Contact Spacing: .120" [3.05mm].
Contact Gauge: #20 AWG.
Minimum Creepage Path Between Contacts: .080" [2.03mm].
Minimum Air Space Between Contacts: .050" [1.27mm].

MATERIAL SPECIFICATIONS

Contact Pin: Brass, gold plated.
Contact Socket: Phosphor bronze, gold plated. (Beryllium copper available on request.)
Guides: Stainless steel, passivated.
Screwlocks: Stainless steel, passivated.
Standard Body: Glass-filled diallyl phthalate per MIL-M-14, Model GDI-30F, green.

DIMENSIONS in inches [millimeters]

<p style="text-align: center;">SMS With Fixed Standard Guides</p>	<p style="text-align: center;">SMDS - DETAIL B Dip Solder Contact Option</p>
<p style="text-align: center;">SMP With Fixed Standard Guides</p>	<p style="text-align: center;">SMDP - DETAIL C Dip Solder Contact Option</p>
<p style="text-align: center;">SMS With Fixed (SL) Screwlocks</p>	<p style="text-align: center;">SMP With Turnable (SK) Screwlocks</p>
<p style="text-align: center;">SMS With Turnable (SK) Screwlocks</p>	<p style="text-align: center;">SMP With Fixed (SL) Screwlocks</p>

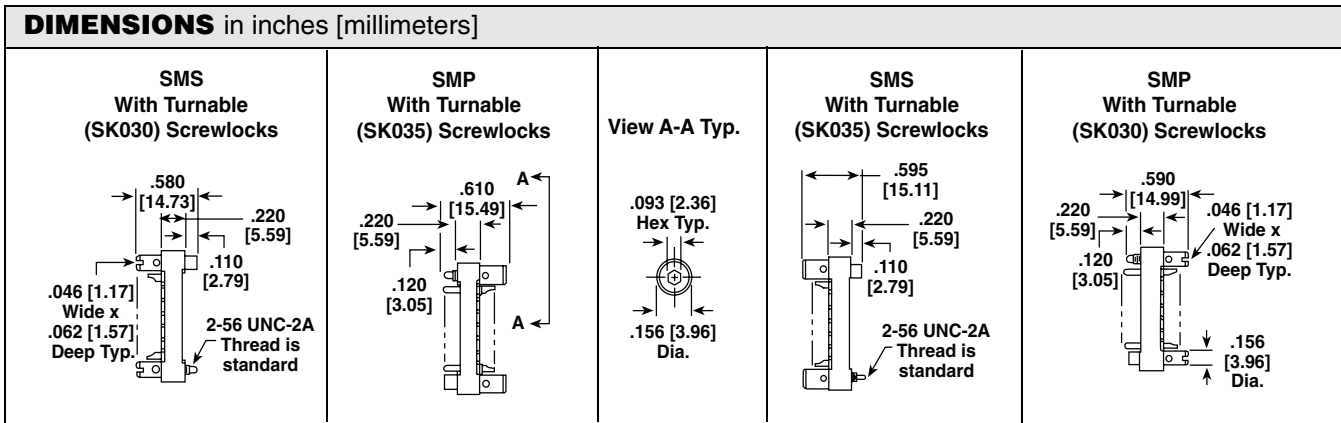

TERMINAL VARIATIONS in inches [millimeters]

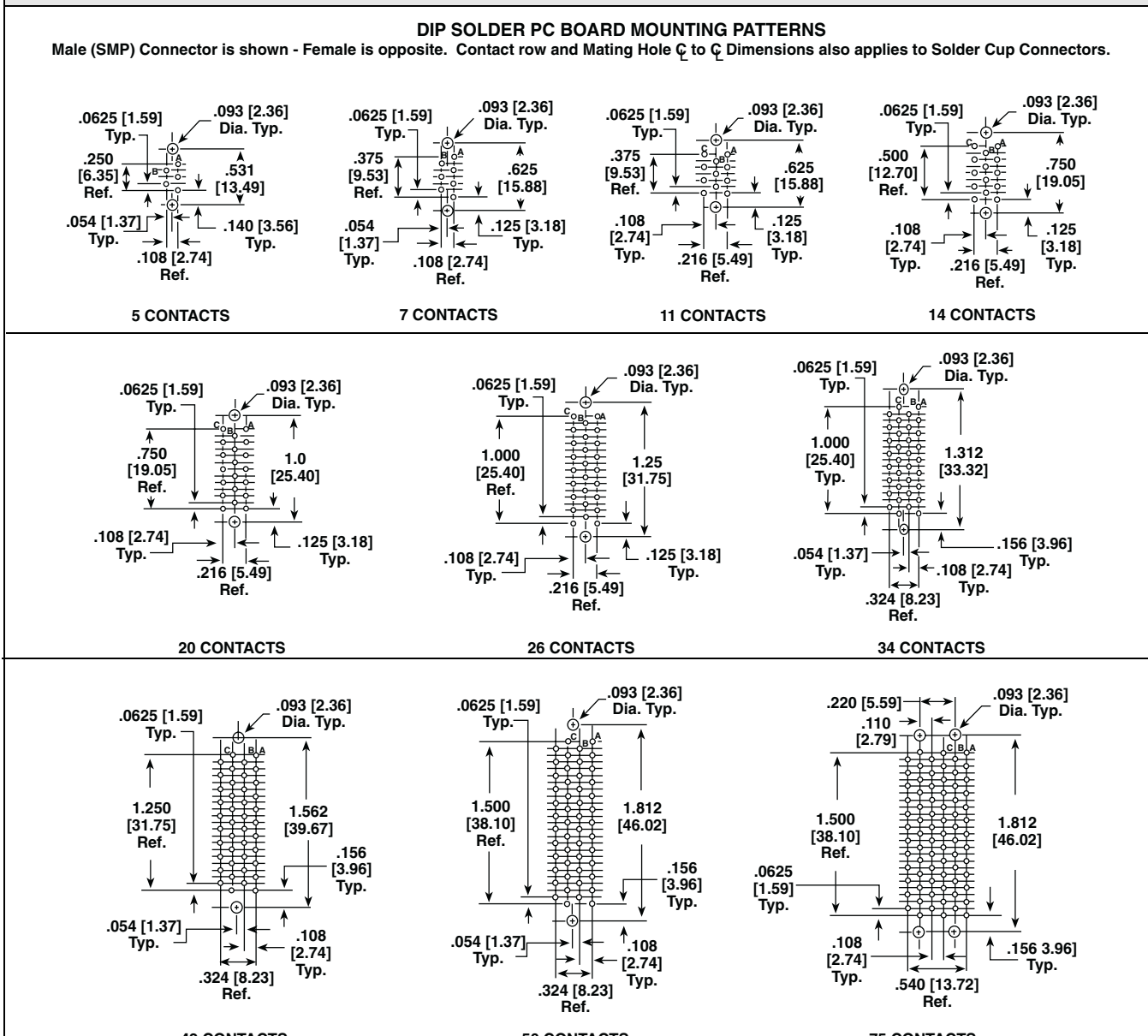

DIMENSIONS in inches [millimeters]

NOTE: The views below show the wiring side of a pin model connector (female is opposite). Socket hardware is assembled at "A" contact end of a pin model connector.

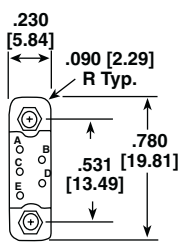

5 CONTACTS

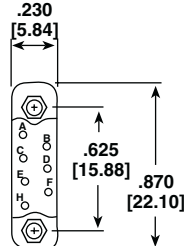

7 CONTACTS

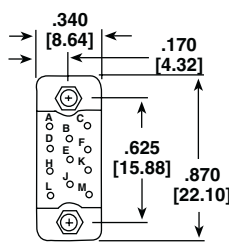

11 CONTACTS

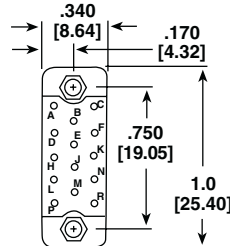

14 CONTACTS

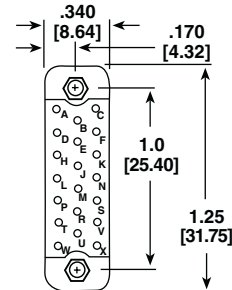

20 CONTACTS

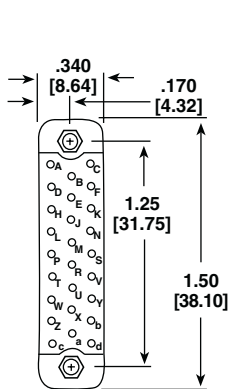

26 CONTACTS

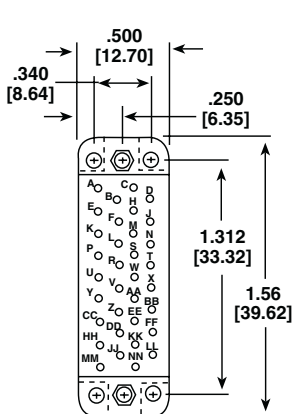

34 CONTACTS

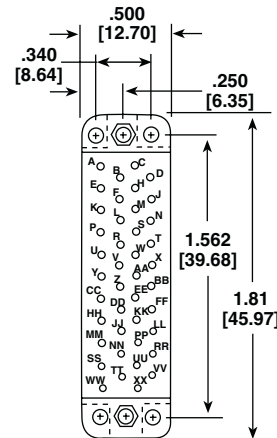

42 CONTACTS

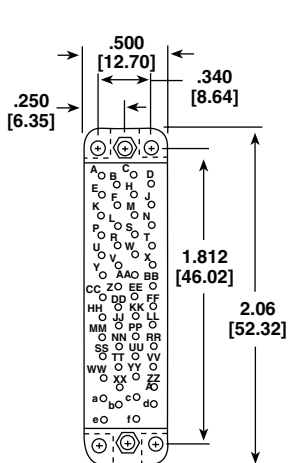

50 CONTACTS

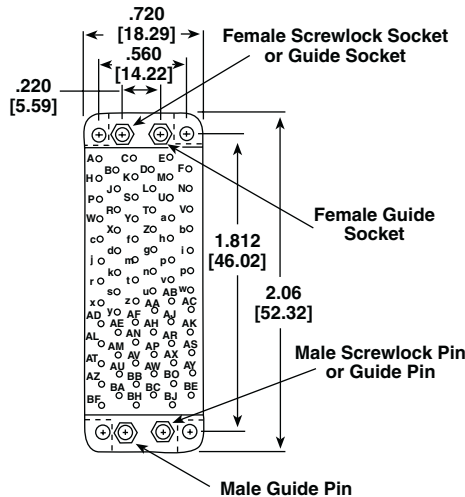

75 CONTACTS

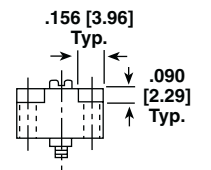

TYPICAL END VIEW
34 THRU 50 CONTACTS

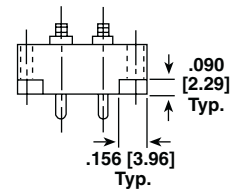

TYPICAL END VIEW
75 CONTACTS

PANEL CUTOUT in inches [millimeters]						
	NUMBER OF CONTACTS	A	B	C	D	FIGURE
<p>FIGURE I</p>	5	.230 [5.84]	.531 [13.49]	.410 [10.41]	—	I
	7	.230 [5.84]	.625 [15.88]	.500 [12.70]	—	
	11	.340 [8.64]	.625 [15.88]	.530 [13.46]	—	
	14	.340 [8.64]	.750 [19.05]	.620 [15.75]	—	
	20	.340 [8.64]	1.0 [25.40]	.910 [23.11]	—	
	26	.340 [8.64]	1.25 [31.75]	1.16 [29.46]	—	
<p>FIGURE II</p>	34	.500 [12.70]	1.312 [33.32]	1.16 [29.46]	.343 [8.71]	II
	42	.500 [12.70]	1.562 [39.68]	1.41 [35.81]	.343 [8.71]	
	50	.500 [12.70]	1.812 [46.02]	1.66 [42.16]	.343 [8.71]	
<p>FIGURE III</p>	75	.720 [18.29]	1.812 [46.02]	1.66 [42.16]	.562 [14.28]	III

ORDERING INFORMATION

C	SM	B	S	20	G	26	R	027*
CONTACTS	MODEL	CONTACT TYPE	CONTACT STYLE	CONTACT SIZE	PLATING	NUMBER OF CONTACTS	(OPTIONAL)	HARDWARE OPTIONS
	Subminiature		P = Pin S = Socket	#20 AWG		5, 7, 11, 14, 20, 26, 34, 42, 50, 75		
(OPTIONAL) Closed entry socket contacts only. Omit for standard contacts.					Optional plating available: G = Gold (.00003 thick) over nickel. G5 = Gold (.00005 thick) over nickel. Omit designator for gold (.00001 thick) over nickel.		(OPTIONAL) R = Reversed guides or screwlocks. Omit for standard.	
		(OPTIONAL) B = Beryllium copper, socket contacts (Solder cup). D = Dip solder contacts.						(Omit if no hardware desired) 027 = Slotted cres guides .090" [2.29mm] diameter. SK = Turnable screwlocks with 2-56 threads. SK3 = Turnable screwlocks with 3-48 threads. SL = Fixed screwlocks with 2-56 threads. SL3 = Fixed screwlocks with 3-48 threads. SK030 = Turnable screwlocks with short slotted knobs. SK035 = Turnable screwlocks with socket head knobs. SK3030 = Turnable screwlocks with short slotted knobs with 3-48 threads. SK3035 = Turnable screwlocks with socket head knobs with 3-48 threads.

EXAMPLES:

SMBS20-26SK035 = Female, 26 beryllium copper socket contacts with socket head knobs on turnable screwlocks for #20 AWG wiring.
SMP20-14SL3 = Male, 14 contact pins, fixed screwlocks with 3-48 threads for #20 AWG wiring.

*To order complete connector with hardware supplied unassembled, add suffix "UA" on end of hardware designation.



Disclaimer

All product specifications and data are subject to change without notice.

Vishay Intertechnology, Inc., its affiliates, agents, and employees, and all persons acting on its or their behalf (collectively, "Vishay"), disclaim any and all liability for any errors, inaccuracies or incompleteness contained herein or in any other disclosure relating to any product.

Vishay disclaims any and all liability arising out of the use or application of any product described herein or of any information provided herein to the maximum extent permitted by law. The product specifications do not expand or otherwise modify Vishay's terms and conditions of purchase, including but not limited to the warranty expressed therein, which apply to these products.

No license, express or implied, by estoppel or otherwise, to any intellectual property rights is granted by this document or by any conduct of Vishay.

The products shown herein are not designed for use in medical, life-saving, or life-sustaining applications unless otherwise expressly indicated. Customers using or selling Vishay products not expressly indicated for use in such applications do so entirely at their own risk and agree to fully indemnify Vishay for any damages arising or resulting from such use or sale. Please contact authorized Vishay personnel to obtain written terms and conditions regarding products designed for such applications.

Product names and markings noted herein may be trademarks of their respective owners.